



# **ID50/60** **operating manual**

997-264, Issue 4 September 2002



# Contents

<b>1</b>	<b>Introduction</b>	<b>1</b>
1.1	Associated Documents	1
1.2	The ID50 / ID60 Series Panel	1
1.2.1	Device Type Abbreviations	2
1.3	Cleaning	2
<b>2</b>	<b>Panel Controls and Indicators</b>	<b>3</b>
2.1	Controls	3
2.2	Indicators	4
<b>3</b>	<b>Automatic Alarms - What to do</b>	<b>5</b>
3.1	Fire	5
3.1.1	Fire in Delayed Mode	7
3.2	Fault	8
3.2.1	Power Fail	9
3.3	Plant Alarm	10
<b>4</b>	<b>Operator Actions at Panel</b>	<b>11</b>
4.1	Introduction	11
4.1.1	Liquid Crystal Display	11
4.1.2	Internal Buzzer	12
4.1.3	Access Codes	12
4.1.4	Keyswitch	13
4.2	RESET Pushbutton	13
4.3	MUTE BUZZER Pushbutton	13
4.4	SILENCE/RESOUND Pushbutton	14
4.5	END DELAYS/EVACUATE Pushbutton	15
4.6	Numeric Keys	16
4.6.1	Cancellation/Termination Button	16
4.6.2	Level 2 Options Menu Button	16
4.7	Level 2 Option Menus	17
4.8	TEST - User Option	18
4.8.1	LEDs - User Option	19
4.8.2	LCD - User Option	19
4.8.3	Zones - User Option	20
4.8.4	Auto High Test - User Option	22
4.8.5	Outputs - User Option	23
4.8.6	Buzzer - User Option	24
4.8.7	Keyboard - User Option	24

---

<b>4.9</b>	<b>DISABLE / ENABLE - User Option</b>	<b>25</b>
4.9.1	<i>Zones - User Option</i>	26
4.9.2	<i>Outputs - User Option</i>	28
4.9.3	<i>Day Mode - User Option</i>	29
4.9.4	<i>Delays - User Option</i>	30
<b>4.10</b>	<b>CLOCK - User Option</b>	<b>31</b>
4.10.1	<i>Time - User Option</i>	32
4.10.2	<i>Date - User Option</i>	33
<b>4.11</b>	<b>VIEW MODE - User Option</b>	<b>34</b>
4.11.1	<i>Log - User Option</i>	35
4.11.2	<i>Devices - User Option</i>	36
4.11.3	<i>Faults - User Option</i>	37
4.11.4	<i>Input Events - User Option</i>	38
4.11.5	<i>Disabled - User Option</i>	39
4.11.6	<i>Alarm Count - User Option</i>	39
4.11.7	<i>Voltages - User Option</i>	40
4.11.8	<i>Version - User Option</i>	41
<b>4.12</b>	<b>Commissioning</b>	<b>41</b>
	<b>Appendix 1 - Log Book</b>	<b>A1-1</b>
	<b>Appendix 2 - Maintenance</b>	<b>A2-1</b>
	<b>Appendix 3 - ID60 Single Loop Panel Differences</b>	<b>A3-1</b>

# ID50 Series Panel

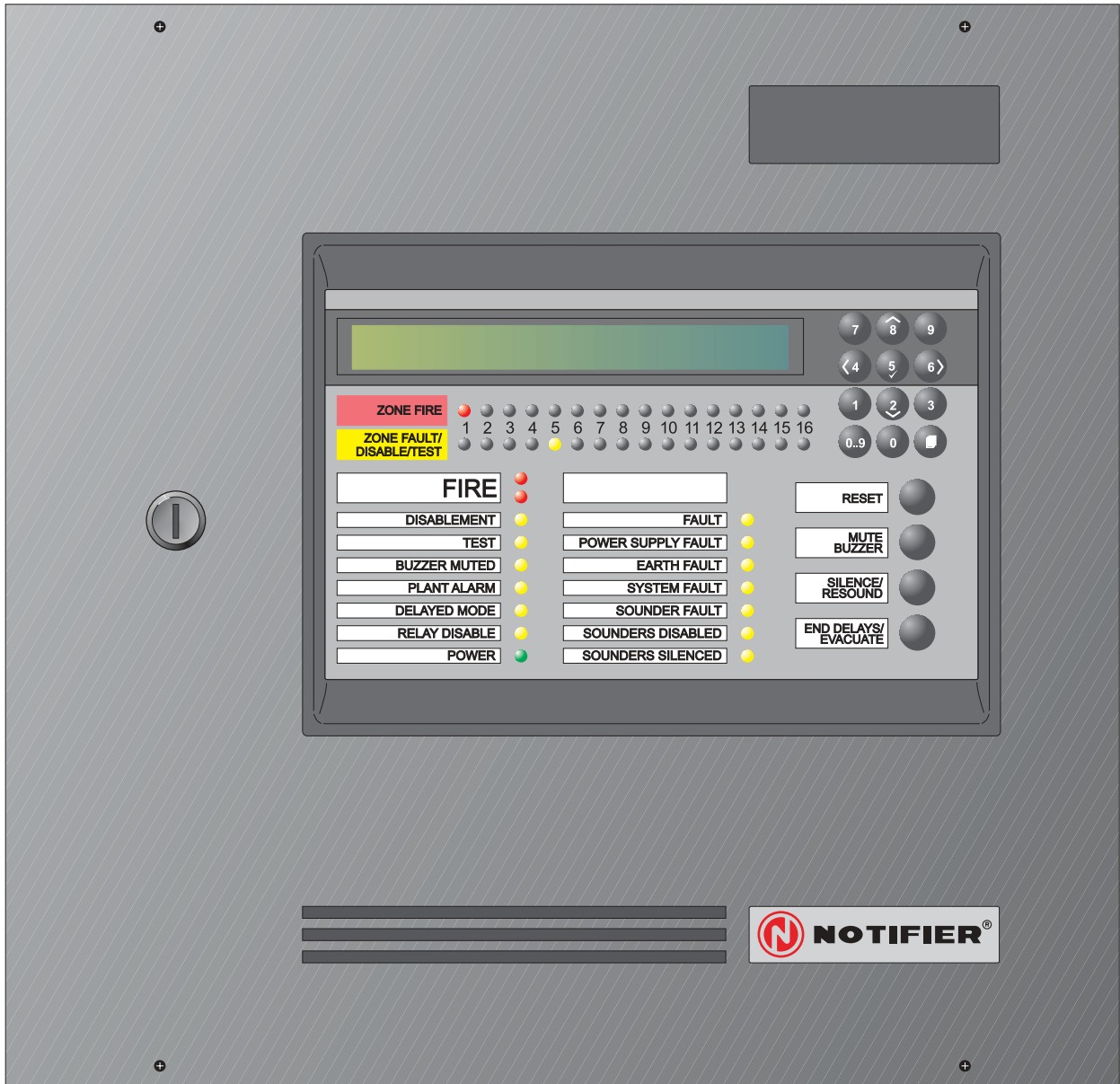

ID50 Series Panel



## 1 Introduction

This manual contains operating instructions for the ID50 and ID60 Series Fire Detection Panels. Differences between the ID50 and ID60 panels are given in **Appendix 3**.

Users of this manual are assumed to be working with a panel that has already been installed and configured appropriately for the area under its supervision.

### 1.1 Associated Documents

This manual does not describe the installation or configuration procedures of the panel. For information on these topics, refer to the **ID50 Series Panel - Installation, Commissioning and Configuration Manual (Ref. 997-263-XXX)**.

### 1.2 The ID50 / ID60 Series Panel

The panel, as supplied by NOTIFIER, is a 1-loop, 16-zone Analogue Addressable Panel. The single loop has the capacity for up to 99 analogue sensors plus up to 99 modules and, in some installations, panels may also be connected to repeaters using the RS485 Communications Link.

All the control and operation functions described in this manual can be carried out using the pushbuttons on the front of the panel.

A keyswitch is provided which, when set to the right, has the same effect as entering an access 2 passcode. Set it to the centre and repeatedly press the '◀4' button until the Status: NORMAL message is displayed to de-select access level 2.

### 1.2.1 Device Type Abbreviations

Throughout this manual the panel may refer to devices by an abbreviated name. The following table lists the device type abbreviation and its description.

Abbreviation	Type Description
AUX	Plant Warning Input
AVR*	Advanced VIEW™ Reference*
AVS*	Advanced VIEW™ Sensor*
CTL	Monitored (Relay Type) Output
ESM	Extinguishant System
ESO	Monitored Extinguishing System Output
EST	Extinguishant Monitor System Trigger
ION	Ionisation Smoke Detector
IRL	Immediate Release Input
MCP†	Manual Call Point†
MLT	Advanced Multi Sensor
MNS	Monitor module (no short-circuit)
MON	Fire Alarm Monitor Input
MRL	Manual Release Input
OPT	Optical/Photo-electric Smoke Detector
RLY	Unmonitored (Relay Type) or O/C Outputs
SDR	Monitored (Sounder Type) Output
TMP	Temperature Detector
ZMX	Conventional Detector Input

**Note:** Devices marked '\*' are supported by the **ID60 Panel** only. The Device marked '†' is also available as 'DKM' - not used in this application (provided to be compatible with VdS requirements).

### 1.3 Cleaning

The panel case may be cleaned periodically by wiping with a soft, damp lint-free cloth.

**Do not** use solvents.





## 2 Panel Controls and Indicators

The panel's controls and indicators are used to operate the overall system and display the panel status. The panel has four function pushbuttons, twelve numeric/cursor keys and thirty-two zonal LED indicators, two 'FIRE' indicators and fourteen system status LED indicators.

An access level 2 keyswitch is provided to enable the operation of panel controls and access to user menus without entering a passcode via the numeric keypad.

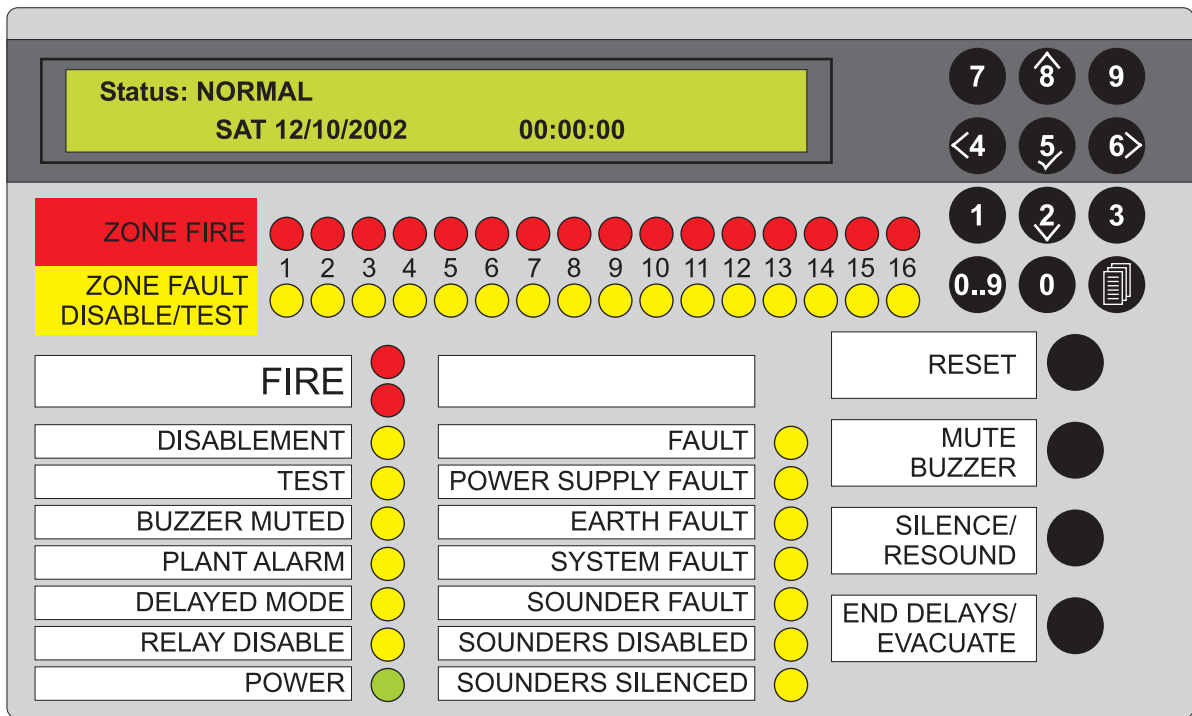

### 2.1 Controls

The pushbuttons are listed below, together with references to the relevant sections of the manual:

#### Function Pushbuttons

- RESET - (Section 4.2).
- MUTE BUZZER - (Section 4.3).
- SILENCE/RESOUND - (Section 4.4).
- END DELAYS/EVACUATE - (Section 4.5).

#### Numeric/Cursor Keys

- Numeric/Cursor keys - (Section 4.6).

#### Keyswitch

Turn the keyswitch to enable level 2 access. The keyswitch provides an alternative to entering the level 2 access code via the numeric keys. See Section 4.1.3 and Section 4.1.4.

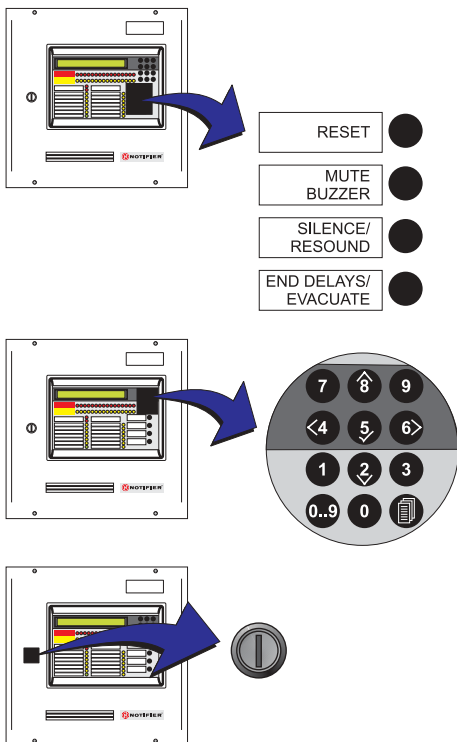

## 2.2 Indicators

The panel status indicators comprise three groups:

- a. Zone Status LED indicators.
- b. Panel/System LED indicators.
- c. Visible/Audible indicators.

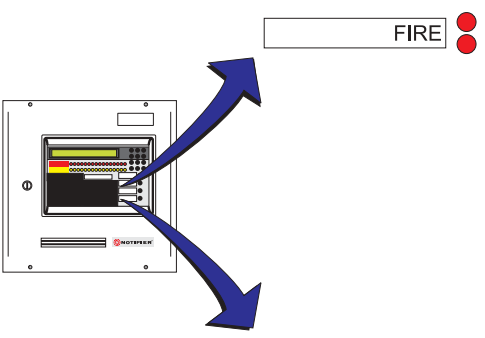
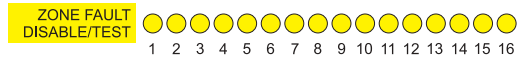
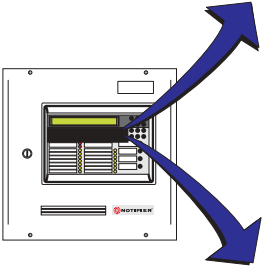
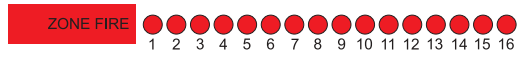

DISABLEMENT	●	FAULT	●
TEST	●	POWER SUPPLY FAULT	●
BUZZER MUTED	●	EARTH FAULT	●
PLANT ALARM	●	SYSTEM FAULT	●
DELAYED MODE	●	SOUNDER FAULT	●
RELAY DISABLE	●	SOUNDERS DISABLED	●
POWER	●	SOUNDERS SILENCED	●

### Zone Status LED Indicators

- ZONE FIRE - these LEDs indicate affected zone(s).
- ZONE FAULT/DISABLE/TEST - these LEDs indicate affected zone(s).

### Panel/System LED Indicators

- FIRE - these LEDs indicate a fire condition.
- Other System Status LEDs:

DISABLEMENT	indicates the presence of a manually-configured disablement.
TEST	indicates a test is in progress.
BUZZER MUTED	indicates the internal buzzer has been silenced.
PLANT ALARM	indicates a fault or warning from a plant-monitoring device.
DELAYED MODE	indicates delays are active.
RELAY DISABLE	indicates relay outputs have been disabled.
POWER	indicates status of power supply.
FAULT	indicates a fault has been detected by the panel.
POWER SUPPLY FAULT	indicates an unsatisfactory power supply to the panel.
EARTH FAULT	indicates an earth fault has occurred.
SYSTEM FAULT	indicates the CPU has reset or a system fault has occurred.
SOUNDER FAULT	indicates a fault with the sounder circuit.
SOUNDERS DISABLED	indicates sounder outputs have been disabled.
SOUNDERS SILENCED	indicates sounder outputs have been silenced.

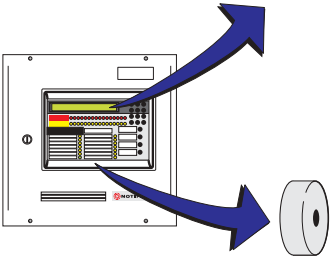

### Visible/Audible Indicators

- Liquid Crystal Display (LCD) - (Section 4.1.1).
- Internal Buzzer - (Section 4.1.2).

### 3 Automatic Alarms - What to do

Before any automatic alarms have been sounded the panel only operates in display mode (quiescent state). The user must then turn the keyswitch to the right or enter a Level 2 access code to enable the panel's pushbuttons.

**Only one alarm condition can be displayed at a time on the LCD.** If fire alarms, faults and/or warning conditions (Plant Alarm) are present on the panel at the same time, they are displayed in the following priority order:

- a. Fire Alarms.
- b. Faults.
- c. Warnings.

The alarm condition is registered in a log.

The user must then enter a Level 2 access code, or turn the keyswitch to the right, to enable the panel's pushbuttons. When the Level 2 access code is active, the '2/8' buttons can be used to scroll through the alarms and the '<4' button will display the first alarm.

#### 3.1 Fire

##### Automatic panel actions:

If the system detects a fire alarm, the panel always does the following automatically:

- a. Operates the internal (high-pitched) buzzer.
- b. Illuminates the red FIRE LEDs, and the numbered red ZONE FIRE LED.
- c. Displays information on the LCD regarding the fire condition. The information includes device address and device location (see example below).

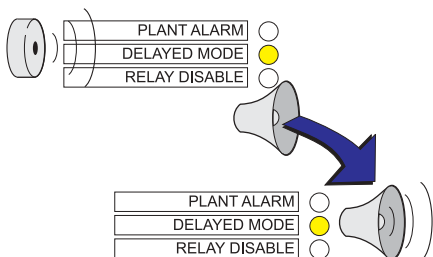
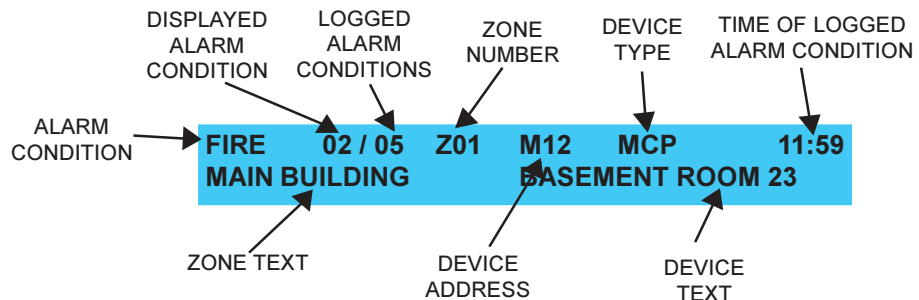
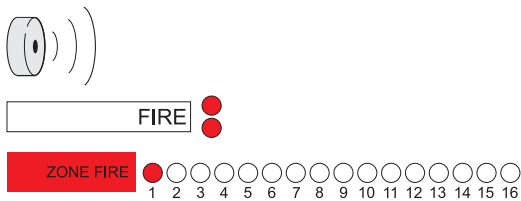

**Note:** If a delay is configured the Delayed Mode LED illuminates. The LED only extinguishes when the delay period has expired.

- d. Operates the sounders and output modules according to the panel's Control-by-Event (CBE) Rules (configured during the Commissioning stage).

**Recommended operator actions:**

**Note:** In the recommended operator actions described below only MUTE BUZZER and END DELAYS are selectable at Access Level 1. The operation of SILENCE, RESOUND, RESET and EVACUATE must only be possible at access Level 2, in accordance with the requirements of EN54:Part 2.

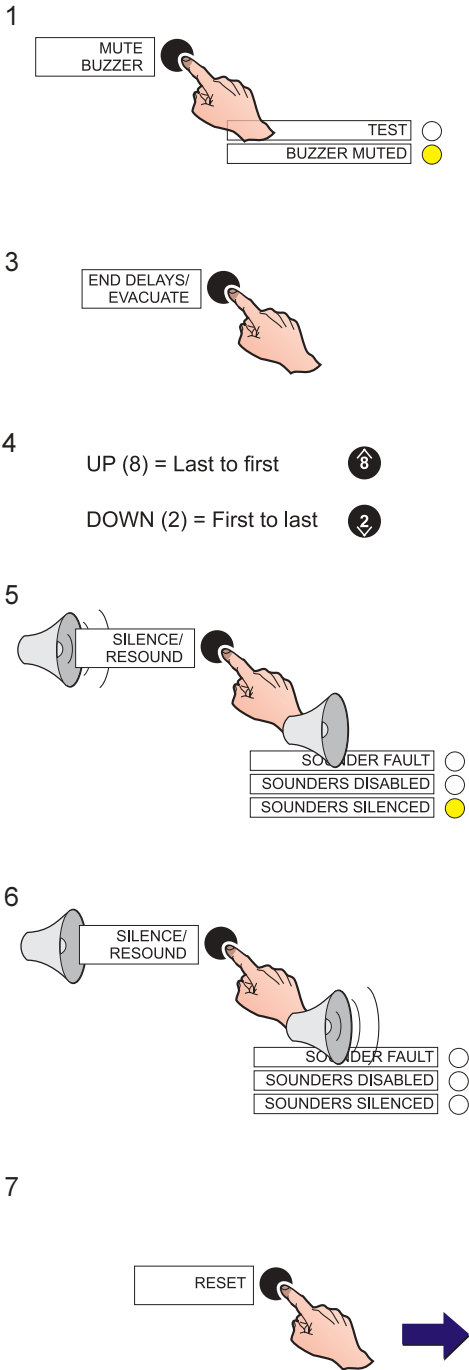

- 1 Operate the MUTE BUZZER pushbutton to silence the panel's internal buzzer. The BUZZER MUTED LED illuminates.
- 2 Follow prescribed instructions for evacuation of premises, notification of Fire Brigade and investigation of source of fire.
- 3 If additional sounder operations are required to achieve a complete and immediate evacuation of the premises, press the END DELAYS / EVACUATE pushbutton. This will cause the internal buzzer to resound, so press the MUTE BUZZER pushbutton to silence.
- 4 When more than one fire Alarm condition is present, it is possible to manually scroll through all logged Fire Alarm conditions using the '2'/'8' arrows.
- 5 When evacuation of the premises is achieved, or at the direction of an authorised person, the Alarm Sounders may be silenced by pressing the SILENCE / RESOUND pushbutton (this illuminates the SOUNDERS SILENCED LED).
- 6 To re-start the sounders, press the SILENCE / RESOUND pushbutton. This extinguishes the SOUNDERS SILENCED LED. You must wait at least 10 seconds after having originally silenced the sounders before resounding them.
- 7 When the cause of the alarm has been removed and call points and input devices have been locally reset, the system may be returned to 'Status: NORMAL'\* by pressing the RESET pushbutton.

**Status: NORMAL**  
**Sat 01/12/2001 00:00:00**

\* Unless the Site name menu was edited during commissioning - refer to **Section 4.1.1 Liquid crystal Display**.

### 3.1.1 Fire in Delayed Mode

The Delayed Mode introduces a delay between an alarm being detected and the sounders and output modules activating. Depending upon the panel configuration, this may be a single delay or a 2-stage delay (an initial brief delay which may be extended by pressing MUTE BUZZER to allow an investigation). The delay is initiated if the panel enters an alarm condition during Delayed Mode.

**Note:** For any configured delays, pressing MUTE BUZZER cancels the initial response time and initiates the fire investigation period. The maximum time for the primary initial response time is 300 secs; **the TOTAL time for both periods is 600 secs.** The delay period can only be configured at Level 3 by the Commissioning Engineer.

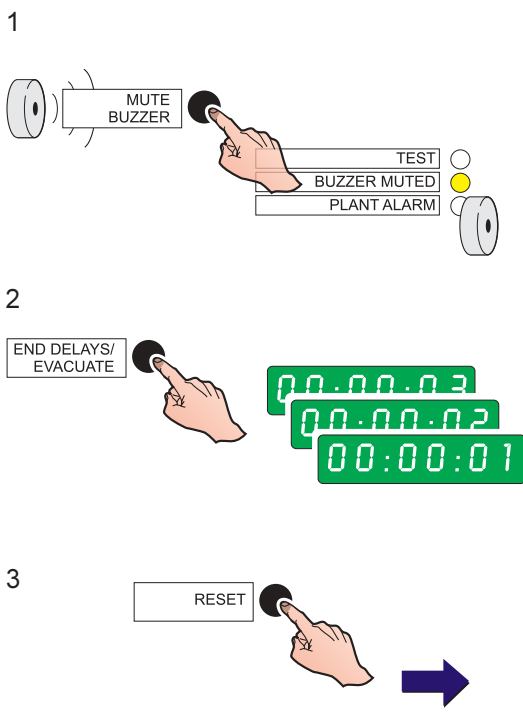
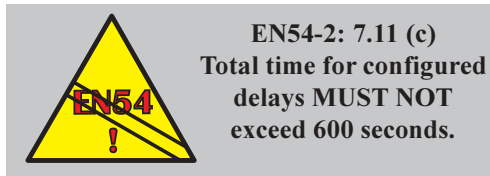

1 When the panel enters a fire condition the delay countdown is started and the internal buzzer sounds. The buzzer can be silenced by pressing the MUTE BUZZER pushbutton. If the 2-stage delay is configured, operating MUTE BUZZER during the primary delay time also starts the extended delay time.

2 If the delay time elapses, a full alarm condition is entered (the configured fire outputs are activated). To cancel the delay, operate the END DELAYS / EVACUATE pushbutton; the full alarm condition is entered and the internal buzzer sounds (it can be silenced by pressing the MUTE BUZZER pushbutton).

**Note:** A Fire alarm in a different zone to the first alarm will also cancel the delay.

3 When the cause of the alarm has been cleared, press the RESET pushbutton to return to the 'Status: NORMAL' message.

### 3.2 Fault

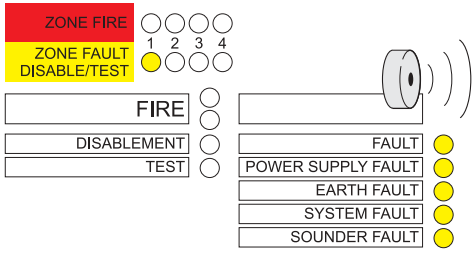

#### Automatic panel actions:

If a fault occurs, the panel automatically does the following:

- Operates the internal buzzer (2 sec. on, 1 sec. off).
- Flashes the appropriate FAULT LEDs, including numbered ZONE FAULT/ DISABLE / TEST LED(s) if appropriate.
- Operates any control outputs which are associated in the Control-by-Event Rules with fault events.

#### Recommended operator actions:

- A fault message typically displays information as follows (not all items apply to all types of fault):
  - Fault condition.
  - Fault number currently displayed.
  - Total number of faults logged.
  - A text message describing the fault.
  - Zone Number.
  - Device Address.
  - Device Type.
  - Time fault was logged.

Depending upon the fault message, either:

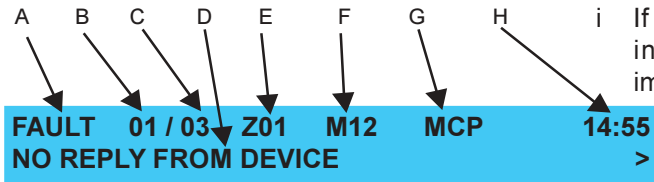

- If the fault message relates to a specific loop device, investigate whether the cause of the fault is immediately apparent and can be corrected.



**Note:** Press the '6>' button to view additional zone text information. To return to the fault message press any numeric/cursor key (if no key is pressed within ten [10] seconds the display automatically returns to the fault message).

- If the fault message relates to a system fault condition, as displayed below, note the full description of the fault and notify the authorised servicing company.

**Note:** e, f, and g are not applicable.

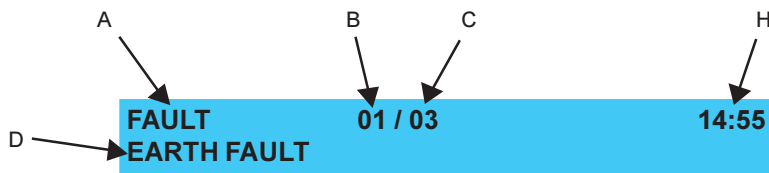

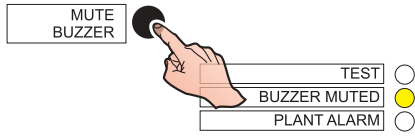

2 If a service contact number has been entered during panel commissioning, the LCD alternates between the fault message(s) and the following:

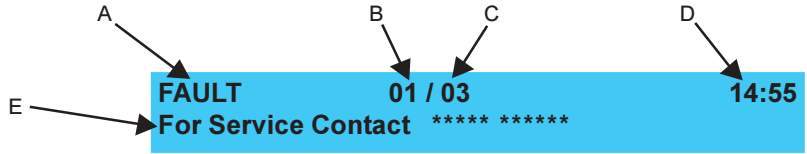

**Note:** Press the MUTE BUZZER pushbutton to silence the panel's internal buzzer (the BUZZER MUTED LED illuminates).

3 When the cause of the fault has been cleared, press the RESET pushbutton.

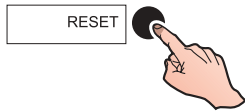

### 3.2.1 Power Fail

1 The loss of a power supply causes the panel to enter a Power Fail condition. The POWER SUPPLY FAULT and general FAULT LEDs illuminate and the internal buzzer operates. The LCD displays:

- a. Fault condition.
- b. Fault number currently displayed.
- c. Total number of faults logged.
- d. Time fault was logged.
- e. A text message describing the fault.

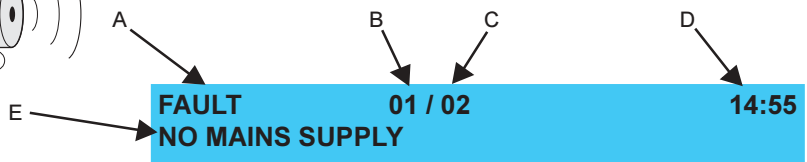
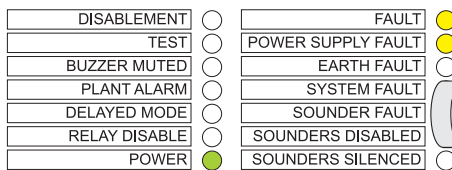
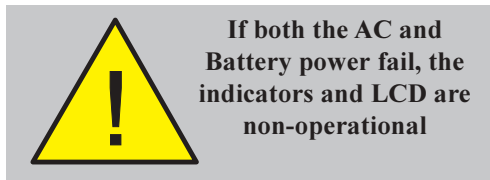

A battery fault is shown on the LCD as follows:



2 If a service contact number has been configured, the LCD alternates between the power fault message and the service contact number.

**Note:** Press the MUTE BUZZER pushbutton to silence the panel's internal buzzer (the BUZZER MUTED LED illuminates).

3 When the cause of the fault has been cleared, press the RESET pushbutton.

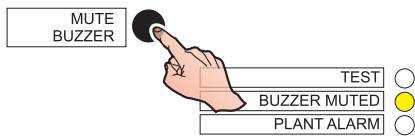

### 3.3 Plant Alarm

A Plant Alarm message is displayed if the panel detects a non-fire input (AUX) configured in zones 17 to 32. When a non-fire event occurs the Plant Alarm LED is illuminated and the LCD displays the following information:

- a. Plant Alarm condition.
- b. Alarm number currently displayed.
- c. Number of alarms.
- d. Zone number.
- e. Device address.
- f. Device type.
- g. Time of logged message.
- h. Zonal and device text (if any).

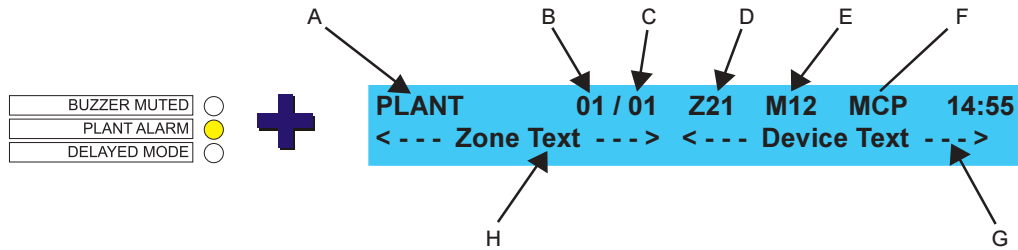

When the cause of the alarm has been cleared, the message will automatically be removed from the LCD and the LED extinguished. The panel returns to quiescent mode.





## 4 Operator Actions at Panel

### 4.1 Introduction

Operator actions at the panel require the correct pushbutton and access code entry. The LCD and the user pushbuttons located on the panel allow the following actions to be carried out:

- a. Panel reset.
- b. Mute the panel buzzer.
- c. Silence and resound the alarms.
- d. End Delays / Evacuate (terminate delays to outputs, if delay is active and activate sounders).
- e. Menu navigation and alphanumeric key entry.
- f. Operator-controlled tests.
- g. Disable and enable of zones, outputs or delays.
- h. Set the clock and date.
- i. View: log, devices, faults, input events, disablements, alarm count, voltages and versions.

All actions are access-controlled either through turning the panel keyswitch to the right, or by entering a Level 2 access code (see **Section 4.1.3 Access Codes**).

#### 4.1.1 Liquid Crystal Display

The Liquid Crystal Display (LCD) provides 80 characters of alphanumeric information on a 2 line display. The LCD is backlit to assist viewing under dim ambient light conditions.

##### System Normal Display

When in a quiescent state the LCD shows the 'Status: NORMAL' message on line 1 and the day, date and time on line 2. The message will be different if the Site Name menu was edited during commissioning.

**Status: NORMAL**  
**Sat 01/12/2001 00:00:00**

The user options are accessed via a menu structure, which in turn is accessed from the 'Status: NORMAL' message (see opposite).

If the 'Status: NORMAL' message is not present, press the '◀4' button repeatedly until it is displayed (this terminates access Level 2 *except when the keyswitch remains turned to the right*).

**Note:** If the Level 3 Commissioning menu is present, press the '0..9' button, then the '7' button to exit this menu.

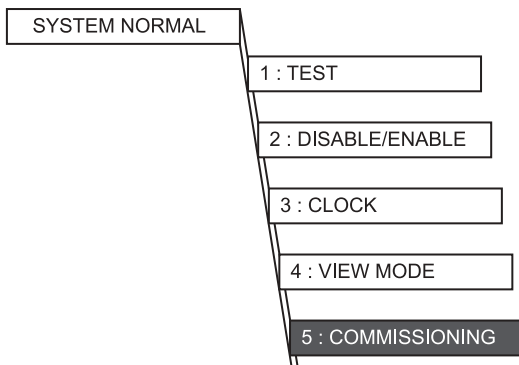

\* The Commissioning Menu is ONLY available with a Level 3 passcode

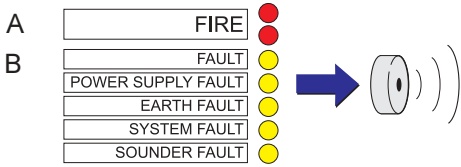

### 4.1.2 Internal Buzzer

The panel has an internal buzzer which gives a local warning when any of the following is detected:

- a. A fire condition.
- b. A fault condition.

### 4.1.3 Access Codes

All actions described in this manual require access Level 2, which is invoked either by turning the keyswitch or by entry of an access code. The access code is a sequence of numbers configured in the panel during commissioning. The panel has two levels of access codes, Level 2 and Level 3. Level 3 is not required for the procedures given in this manual (it is required during configuration and commissioning).

The panel has a maximum of ten (10) Level 2 access codes, each defined by the user identification number [U0 - U9] in the top left-hand corner. Entering a Level 2 access code allows access to all functional controls and some system operation parameters. (Operating the keyswitch to enter Level 2 always displays [U9]).

**Note:** When the panel is at Level 3, [S1] is displayed in place of the user identification number.

- 1 Press the '📄' button at the 'Status: NORMAL' message to prompt for a Level 2/3 access code, as shown below:

**ACCESS TO MENU RESTRICTED**  
Enter Level 2/3 Passcode: . . . .      < : BackSp

- 2 Press and hold the '0..9' button while pressing the appropriate 4 digit Level 2 access code. '\*' will appear on the LCD as the numbers are entered.

**ACCESS TO MENU RESTRICTED**  
Enter Level 2/3 Passcode: \* \* \* \*      < : BackSp

- 3 Press the '5' button to confirm the entered code. The Level 2 Options are then displayed.

**[U0] 1:Test    2:Disable/Enable    3:Clock**  
**4:View Mode    5:Commission**

- 4 The procedure to cancel Level 2 (and thus prevent any other person accessing Level 2 options) is given in **Section 4.1.1**).

**Note:** If an incorrect access code is entered, the following is displayed:

**ERROR - INCORRECT PASSCODE !!!**

Press the '4' button or wait for approximately one minute to return to the 'Status: NORMAL' message.

**TIP!** Operations within this manual require Level 2 access (code or keyswitch), although a Level 3 access code may be entered

**TIP!** Throughout this manual a U accompanied by a number represents a Level 2 access code

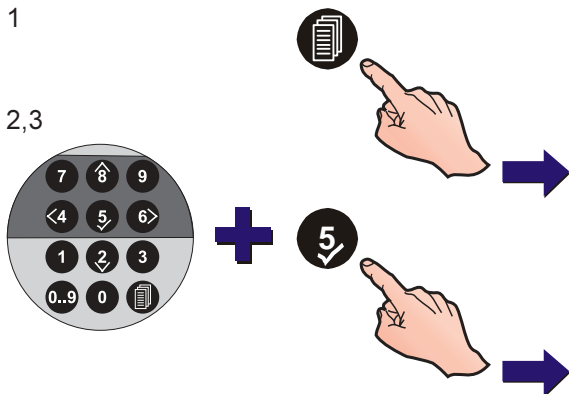

### 4.1.4 Keyswitch

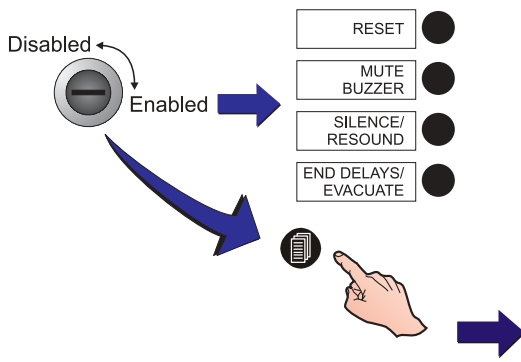

The panel is fitted with a keyswitch which provides an alternative to the Level 2 access code. If the keyswitch is in the enabled position, it overrides the requirement for a Level 2 access code. Therefore, if an alarm condition occurs the keyswitch enables the immediate operation of the control keys.

With the keyswitch in the enabled position the Level 2 menus are accessible by pressing the 'Ⓚ' button.

```
[U0] 1:Test    2:Disable/Enable    3:Clock
      4:View Mode    5:Commission
```

### 4.2 RESET Pushbutton

The RESET pushbutton is used to clear all non-quiescent conditions and return the panel to a normal quiescent condition. Provided that the control keys have been enabled for Level 1 operation, the following occurs:

- All FIRE and FAULT lamps are switched off.
- All sounders cease to operate.
- The system status returns to NORMAL provided that no operator actions are being carried out.

If the pushbuttons are enabled to operate at Level 2, follow the procedure below:

- Press the RESET pushbutton. The LCD displays the following:

```
CONTROL KEY LOCKED - ACCESS REQUIRED
Enter Level 2/3 Passcode: . . . . < : BackSp
```

- Enter an appropriate Level 2 access code and confirm using the '5' button.

```
CONTROL KEY LOCKED - ACCESS REQUIRED
Enter Level 2/3 Passcode: * * * * < : BackSp
```

If Alarm(s), and/or Fault(s) conditions are still present when RESET is operated, the condition will be reported as if it were a completely new event with appropriate annunciation.

### 4.3 MUTE BUZZER Pushbutton

Operating the MUTE BUZZER pushbutton when an alarm or fault has occurred, silences the internal buzzer. If the Primary Delay is active during an alarm condition this pushbutton will also terminate this delay and start the Extend Delay time.

The internal buzzer remains silent until the system is RESET or the panel detects another alarm condition.

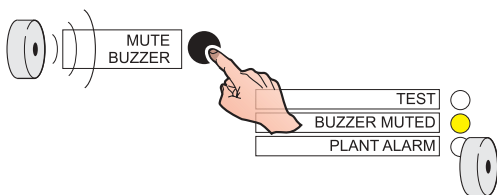
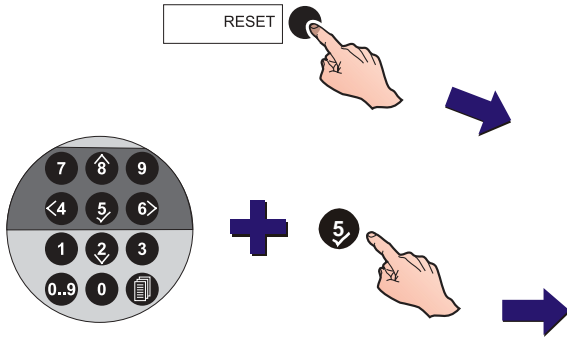

#### 4.4 SILENCE / RESOUND Pushbutton

The term 'silence' as used throughout this manual, describes a temporary state the panel enters whenever the SILENCE / RESOUND pushbutton is pressed to stop the sounders operating. While the panel is in this state, a new fire alarm, operating the SILENCE / RESOUND pushbutton again or operation of the END DELAYS / EVACUATE pushbutton, will re-sound all previously silenced sounders.

You can suspend all sounder output delays and silence all sounder outputs which are operating as a result of a FIRE alarm or an EVACUATE operation. Provided that the pushbuttons have been enabled for Level 1 operation and delays are active, proceed as follows:

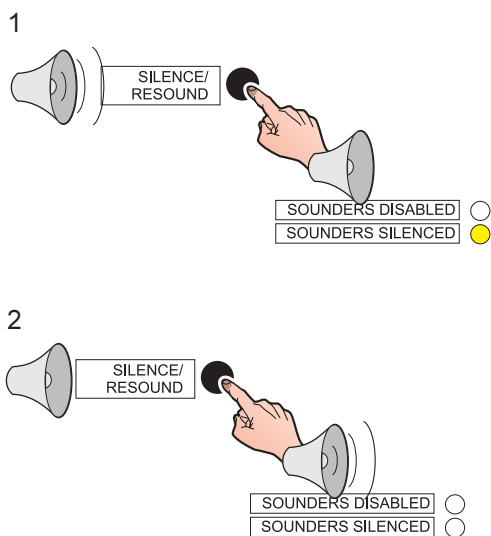

- 1 Press the SILENCE / RESOUND pushbutton. The following are not switched off by this operation:
  - a. The internal FIRE buzzer.
  - b. Any output modules configured in the CBE Rules during commissioning NOT to be silenced by the SILENCE / RESOUND pushbutton.
- 2 To start the sounders again in the same pattern as they were previously operating and reactivate any programmed delays, press the SILENCE / RESOUND pushbutton.

**Note:** If the pushbuttons are enabled to operate at Level 2, enter the Level 2 passcode in the manner described in the RESET pushbutton procedure (**Section 4.2**).

## 4.5 END DELAYS / EVACUATE Pushbutton

The END DELAYS / EVACUATE pushbutton is used to initiate the Evacuate procedure. If this pushbutton is operated while a delay is active, all delays are cancelled and all sounders designated in the pre-configured Evacuate pattern are activated. Providing the pushbuttons have been enabled for Level 1 operation and delays are active the following occurs:

- 1 Press the END DELAYS / EVACUATE pushbutton. The following is displayed:

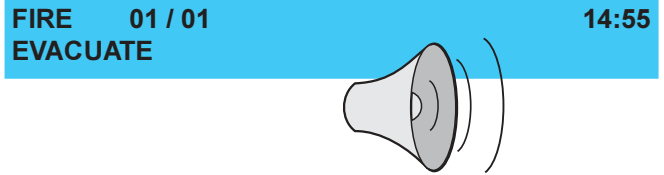
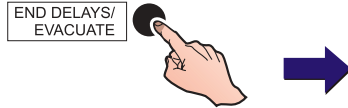

- 2 No further action is needed until it is required to silence the sounders, in which case the SILENCE / RESOUND pushbutton should be pressed, see **Section 4.4, Silence / Resound pushbutton**.

**Note:** If the pushbuttons are enabled to operate at Level 2, enter the Level 2 passcode in the manner described in the RESET pushbutton procedure (**Section 4.2**).

### 4.6 Numeric Keys

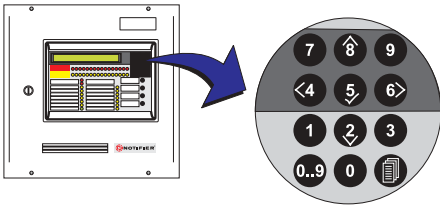

When using any numeric key, each operation is confirmed by a sharp audible beep.

At Access Level 1, the numeric buttons have NO function until an alarm condition occurs. The alarm condition enables the '**2**' and '**8**' buttons, allowing the user to view each alarm in turn.

At Access Level 2 the '**2**'/'**8**' function remains identical to the Level 1 function. The '**4**' (cancel), '**5**' (confirm), '**6**' (go to next option) buttons are enabled. Numeric entry (used in conjunction with the '**0..9**' [shift] button) is also enabled.

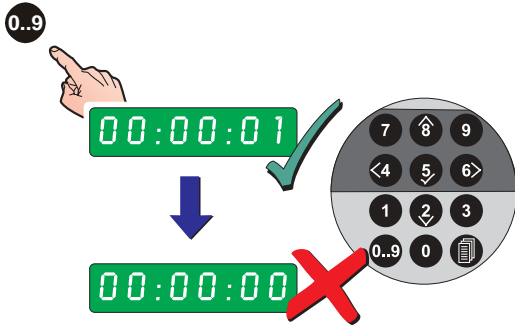

- Use the '**2**' and '**8**' buttons to scroll through fire alarms, fault conditions, and warning conditions or to view the 'More' menu list when available.
- Press the '**5**' button to confirm an option.
- Press the '**0..9**' (Shift) button to enable number entry. Following the input of a number (approx. 1 sec later) a second audible beep indicates that number entry is no longer enabled.

**TIP!** It is possible to press and hold the '**0..9**' (Shift) pushbutton while entering numbers



#### 4.6.1 Cancellation/Termination Button

To cancel or terminate configuration data entry, press the '**4**' button. The LCD returns to the previous menu.

To cancel access rights, press the '**4**' button until the 'Status: NORMAL' message is displayed.

#### 4.6.2 Level 2 Options Menu Button

Operating the '**0..9**' button enables the Level 2 menu and prompts for the entry of an appropriate access code, as described in **Section 4.1.3 Access Codes**.

### 4.7 Level 2 Option Menus

The following Level 2 Option Menus are available after a correct Level 2 access code has been input or the keyswitch has been operated.

The menu map at left shows an overview of the Level 2 menus. The Commissioning menu is shown inverted to indicate that a Level 3 access is required.

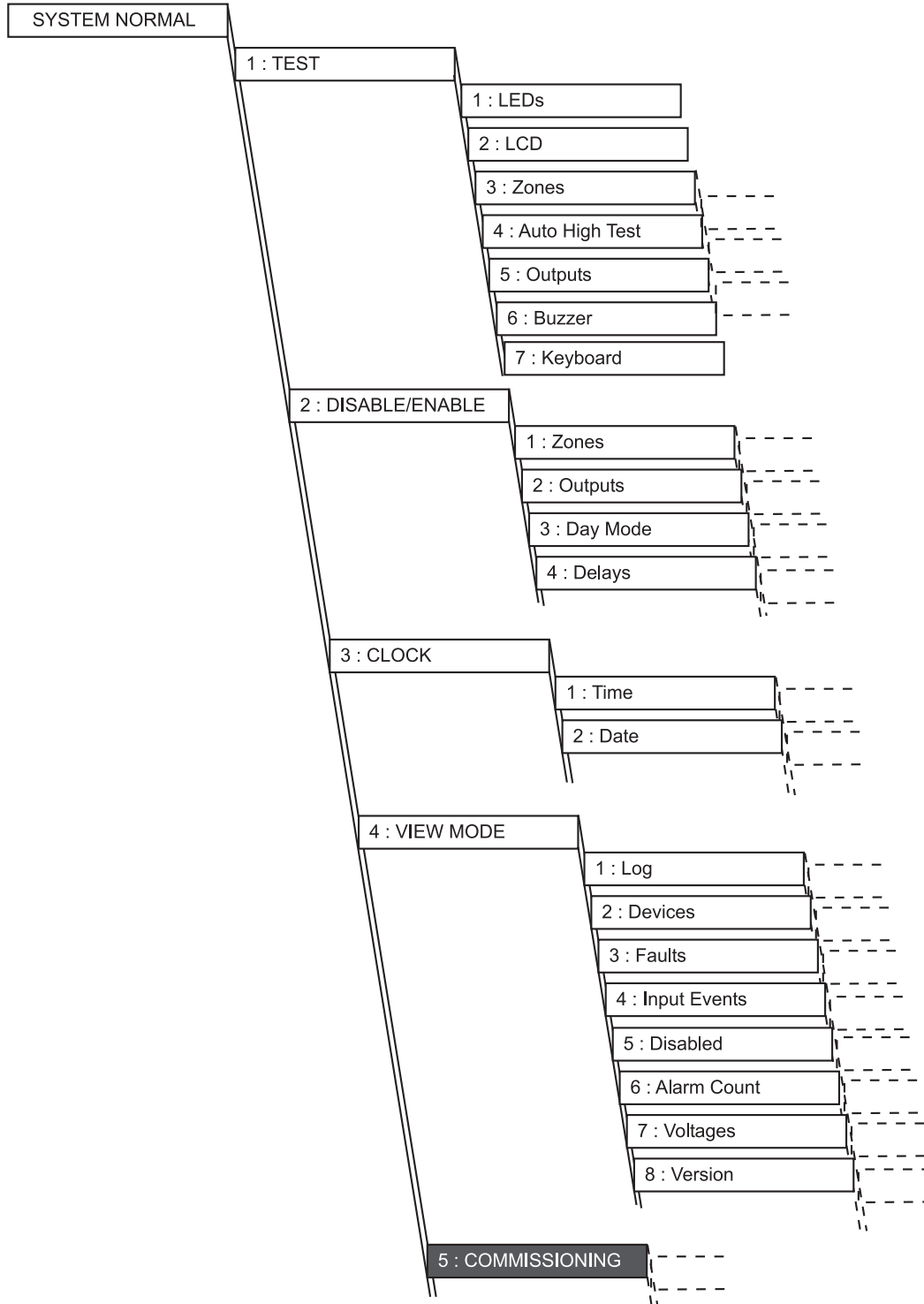

**Note:** Level 3 Configuration Menus are described in **997-263, ID50 Series Panel Installation, Commissioning & Configuration Manual, Section 5 Configuration.**

## 4.8 TEST - User Option

The following tests are available at Access Level 2 from the Test - User Option menu:

- a. LEDs.
- b. LCD.
- c. Zones.
- d. Auto High Test.
- e. Outputs.
- f. Buzzer.
- g. Keyboard.

To start the TEST - User Option:

- 1 At the 'Status:NORMAL' message, press the '📄' button. The LCD prompts for a Level 2/3 access code. (To cancel, press '⏪').

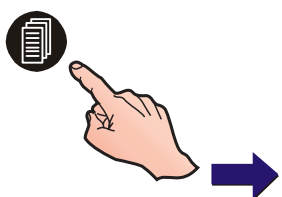

**ACCESS TO MENUS RESTRICTED**  
Enter Level 2/3 Passcode: . . . . < : BackSp

**Note:** Entering an incorrect access code causes the LCD to display the 'ERROR - INCORRECT PASSCODE !!!' message, then an automatic return to the access code prompt.

- 2 Either turn the keyswitch or, using the numeric keypad, enter the correct Level 2 access code and confirm using the '5' button. The User Option menu is displayed with the user number ([U0] to [U9]) in the top left-hand corner.

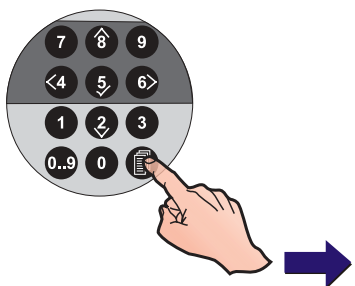

**[U0] 1 : Test 2 : Disable/Enable 3 : Clock**  
**4 : View Mode 5 : Commission**

### Extinguishing System - Testing SLC device outputs.

To prevent inadvertant operation of the direction and release valves during testing, zones containing the associated SLC devices **MUST FIRST** be put into TEST mode. Also, where a zone test is manually activated using an input module, extinguishant bottles **MUST FIRST** be disconnected to prevent unauthorized extinguishant discharge.

**Note:** A manual release reset will not stop the extinguishant discharge because of a physical link between the direction valve inputs and outputs.



### 4.8.1 LEDs - User Option

This option, selected from the Test menu, illuminates each LED in turn. To test the panel LEDs, enter access Level 2 and follow the procedure below:

- Using the numeric keypad, press '1' to display the TEST menu.

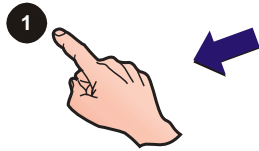

[U0] 1 : Test 2 : Disable/Enable 3 : Clock  
4 : View Mode 5 : Commission

- To test LEDs, press the '1' button on the numeric keypad.



[U0 Test] 1:LEDs 2:LCD 3:Zones  
4:Auto High Test 5:Outputs ↑ : More

- Each of the panel LEDs illuminates in turn while the LCD flashes the message shown below. When all LEDs have been tested, press the '<4>' button to cancel and return to the Test menu.

TESTING LEDs !!!

### 4.8.2 LCD - User Option

The LCD Option, selected from the Test menu, tests the LCD by displaying each upper case character in turn. To test the LCD, enter access Level 2 and follow the procedure below.

- Using the numeric keypad, press '1' to display the TEST menu.

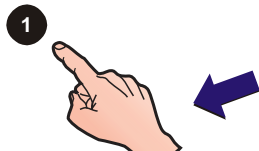

[U0] 1 : Test 2 : Disable/Enable 3 : Clock  
4 : View Mode 5 : Commission

- To test the LCD, press the '2' button on the numeric keypad.

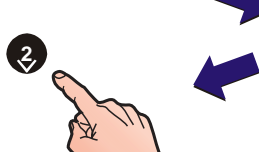

[U0 Test] 1:LEDs 2:LCD 3:Zones  
4:Auto High Test 5:Outputs ↑ : More

- Each character is then displayed in turn on the LCD. When all characters have been displayed, press the '<4>' button to cancel and return to the Test Menu.

AA  
AAAAA  
BBB  
BBB  
ZZ  
ZZ

### 4.8.3 Zones - User Option

The Test Zones option, selected from the Test Menu, allows the user to perform a walk test on one zone at a time.

During the walk test the TEST and relevant ZONE FAULT/DISABLE/TEST LEDs are illuminated, indicating that the system and zone is in TEST mode. To perform a walk test, at the TEST menu:

1

- 1 Press the '3' button on the numeric keypad to select the walk test procedure.

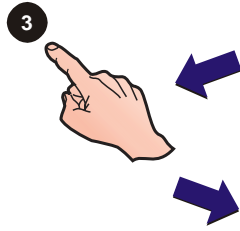

**[U0 Test]    1:LEDs    2:LCD    3:Zones**  
**4:Auto High Test    5:Outputs    ↑ : More**

2

- 2 The LCD displays the Test Zones menu. Select either the Ring Sounders or No Sounders walk test:

**[U0 Zones]    1: Ring Sounders**  
**2:No Sounders    3:View/Stop Test    ↑ : More**

- a. Using the numeric keypad press '1' to display the Ring Sounders menu as below. In this mode the sounders will ring for a few seconds when a device is tested, then reset automatically.

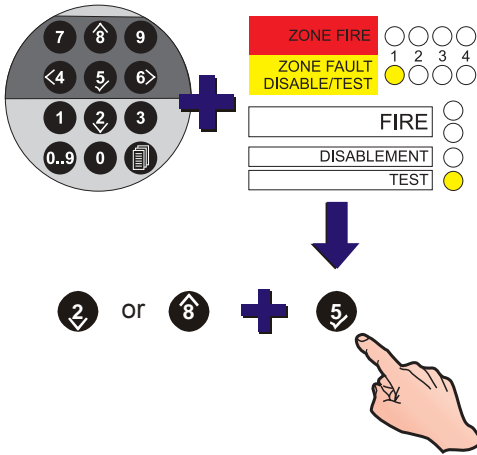

**[WALK TEST (Sounders)]    Select Zone:01**  
**✓ : Start    ↑ : Change    <:Exit**

- i Use the '2/8' buttons to select the zone to be tested. Press the '5' button to confirm the zone number.

**[WALK TEST (Sounders)]    Select Zone: 01**  
**Press ✓ to Confirm    <:Cancel**

- ii The LCD prompts for confirmation. Press the '5' button to start the walk test for this zone. Repeat steps i and ii for any further zones to be tested. Test the devices (see Checking the Devices overleaf).

**[WALK TEST (Sounders)]    Select Zone: 01**  
**✓ : Start    ↑ : Change    <:Exit**

- iii Press the '<4' button to exit the Ring Sounders menu and return to the Zones menu.

- b. To walk test devices on a specific zone without activating the sounders, press '2' on the numeric keypad to select the 'No Sounders' option. The walk test procedure is otherwise the same as given above for 'Ring Sounders'.

3 To end the walk test:

- a. For a specified zone: at the Test Zones menu, press the '**3**' button on the numeric keypad to select the View/Stop Test menu:

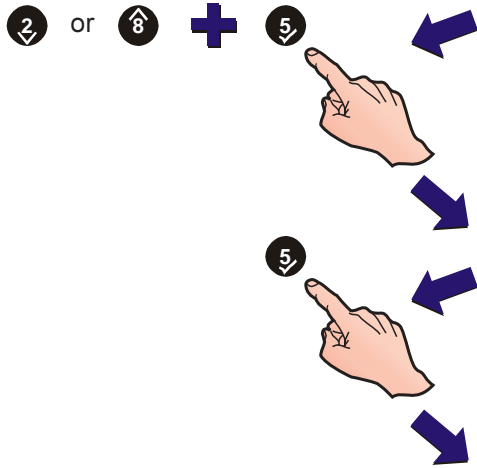

**[STOP WALK TEST] Select Zone: 01**  
 ✓ : Stop                      ↑ : Change                      <:Exit

- i Use the '**2**'/'**8**' buttons to select the zone, then press the '**5**' button to confirm the zone number.

**[STOP WALK TEST] Select Zone: 01**  
 Press ✓ to Confirm                      <:Cancel

- ii Press the '**5**' button to stop the walk test for the selected zone. If no other walk tests are active, the following is displayed:

**The system has no walk test zones active**  
 <:Exit

- iii Press the '**4**' button to exit the Walk Test menu and return to the Test Zones menu.

- b. For all zones: from the '↑ : More' option ('**2**'/'**8**') press the '**4**' button on the numeric keypad to select the Stop All menu:

**[U0 Zones] 1: Ring Sounders**                      ↑ : More  
 2:No Sounders                      3:View/Stop Test

**[U0 Zones] 4: Stop All**                      ↑ : More

**Stop all Zones in Walk Test ?**  
 Press ✓ to Confirm                      <:Cancel

- 4 To exit the Test Zones menu, press the '**4**' button. Continue pressing this button until the required menu or the 'Status: NORMAL' message is displayed.

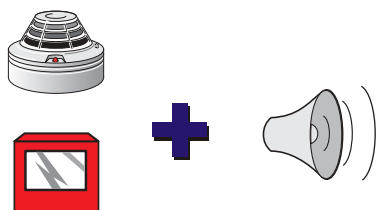

### Checking the Devices

Use the following methods to check devices during a walk test:

- i. Test sensors by applying smoke or heat as appropriate, or by operating the device's internal test switch by means of a magnet.
- ii. Test Manual Call Points by using a test key.

For each device, the panel will record the event in the log, sound its internal buzzer, illuminate the appropriate ZONE FIRE LED and turn on the LED at the device that initiated the alarm.

After a few seconds, the panel will automatically return to Test Mode and the device LED will be turned off. The panel is then ready to test the next device.

**Note:** Up to one minute must be allowed for smoke sensors to clear.

If a fire alarm signal is received from a zone other than those being tested, all sounder output and relay output circuits will activate as configured for a zone in alarm. The sounders will continue to ring until silenced from the panel.

#### 4.8.4 Auto High Test - User Option

The Auto High Test, if configured during commissioning, automatically polls and tests all devices on the loop at a specified time of day. This test takes about 70-80 seconds to complete. To run the test manually:

- 1 From the Test Menu, using the numeric keypad press the '**4**' button to select the Auto High Test.

```
[U0 Test]    1:LEDs    2:LCD    3:Zones
             4:Auto High Test    5:Outputs    ↓ : More
```

- 2 When the LCD displays the start Auto High Test message, press the '**5**' button to start the test.

```
Manually start automatic high test ?
Press ✓ to confirm                <:Cancel
```

- 3 The LCD displays the message shown below, then re-displays the Test Menu.

**Automatic high test started !!!**

- 4 If a fault occurs while the Auto High Test is active the LCD displays a fault message (example given below):

```
FAULT      01 / 03  Z01  M12 MCP      14:55
DEVICE FAILED AUTO HIGH TEST      >
```

Press the '**6**' button to display additional zonal and device text information. Press the '**4**' button to return to the Test menu. Clear the fault and repeat the test.

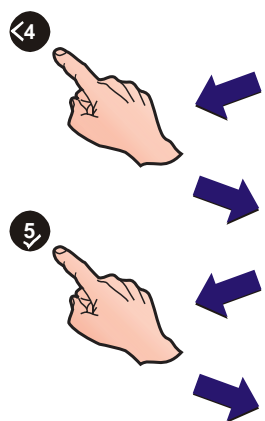

### 4.8.5 Outputs - User Option

The Test Outputs option, accessed from the Test Menu, tests the panel's internal sounder and relay circuits and the Signalling Line Circuit (SLC) loop outputs. To perform this test:

#### Test Internal Outputs

1 From the Test Menu, press the '5' button on the numeric keypad to select the Outputs option.

[U0 Test]	1:LEDs	2:LCD	3:Zones
4:Auto High Test	5:Outputs	↓ : More	

[U0 Outputs]	1:Internal	2:SLC
--------------	------------	-------

2 The LCD displays the Outputs menu. Press the '1' button on the numeric keypad to display the Internal Test menu.

[Internal Test]	B:01	SDR
✓ : Start	↑ : Change Output	<:Exit

3 Use the '2'/'8' buttons to select the internal output required for testing and press the '5' button to start the test. The LCD then displays the following:

[Internal Test]	B:01	SDR
Output test in progress	<:Stop	

4 Check that the output operates. To stop the test, press the '<4' button. Press the '<4' button again to return to the Test Outputs menu.

#### Test SLC Outputs

1 From the Outputs menu, press the '2' button on the numeric keypad to display the SLC Output Test menu:

[U0 Outputs]	1:Internal	2:SLC
--------------	------------	-------

[SLC Test]	M:01	SDR
✓ : Start	↑ : Change Output	<:Exit

2 Use the '2'/'8' buttons to select the output required for testing and press the '5' button to start the test. The LCD then displays the following:

[SLC Test]	M:01	SDR
Output test in progress	<:Stop	

3 Check that the output operates. To stop the test, press the '<4' button. Press the '<4' button again to return to the Test Outputs menu.

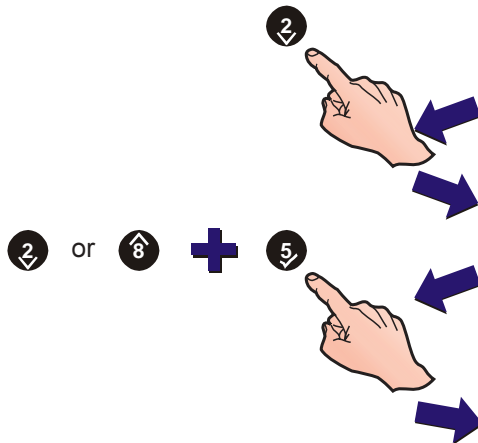
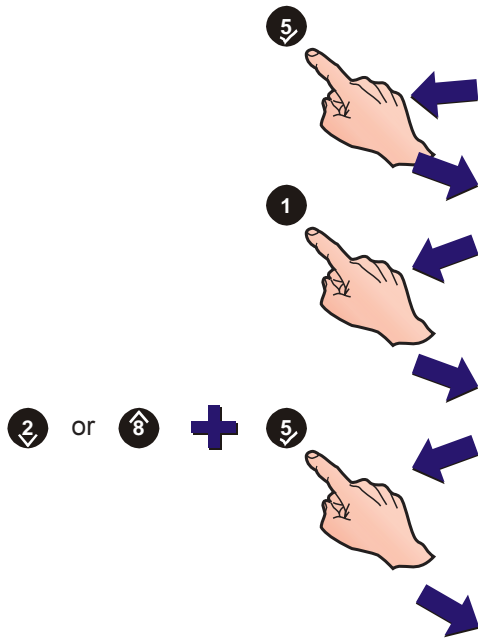

### 4.8.6 Buzzer - User Option

The Buzzer User Option, selected from the Test Menu, tests the internal buzzer. Proceed as follows:

- Using the numeric keypad, press '1' to display the TEST menu.

[U0] 1 : Test 2 : Disable/Enable 3 : Clock  
4 : View Mode 5 : Commission

- Press the '2/8' pushbuttons to display the next screen options. To test the buzzer, press the '6' button on the numeric keypad.

[U0 Test] 6:Buzzer 7:Keyboard  
↑ : More

- The buzzer sounds with a 2:1 mark:space ratio and the LCD flashes the message below. Press the '<4' button to cancel the test and return to the Test Menu.

TESTING BUZZER !!!

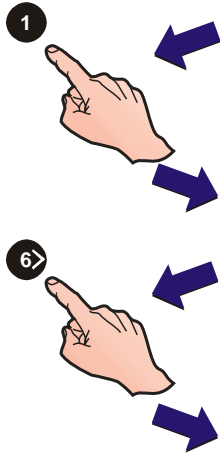

### 4.8.7 Keyboard - User Option

This option allows the panel keyboard to be functionally tested.

- Using the numeric keypad, press '1' to display the TEST menu.

[U0] 1 : Test 2 : Disable/Enable 3 : Clock  
4 : View Mode 5 : Commission 6:Print

- Press the '2/8' pushbuttons to display the next screen options. To test the keyboard, press the '7' button on the numeric keypad.

[U0 Test] 1:LEDs 2:LCD 3:Zones  
4:Auto High Test 5:Outputs ↑ : More

[U0 Test] 6:Buzzer 7:Keyboard  
↑ : More

- The following screen is displayed. Press each panel pushbutton in turn. When a pushbutton is pressed, the corresponding display entry is replaced by an equivalent number of asterisk (\*) characters. Once all pushbuttons have been pressed the display will return to the test menu. The keyboard test will automatically abort after one minute if no key is pressed.

Press ALL keys to exit . . .  
0..9 0 MENU 1 2 3 4 5 6 7 8 9 A B C D

- RESET ● = A
- MUTE BUZZER ● = B
- SILENCE/ RESOUND ● = C
- END DELAYS/ EVACUATE ● = D

 The standard function of the control keys is suppressed while this test is active. Normal function resumes upon test completion.

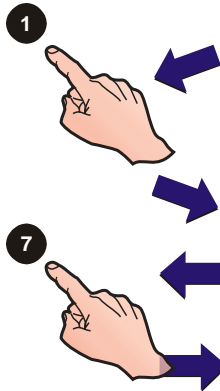

### 4.9 DISABLE / ENABLE - User Option

This option allows the user to disable or enable (depending on their current state) the following parts of the system:

- a. Zone (Device or Full Zone).
- b. Outputs.
- c. Day Mode.
- d. Delays.

To display the DISABLE/ENABLE menu:

- 1 At the 'Status: NORMAL' message, press the '📄' button. The LCD prompts for a Level 2/3 access code.

2

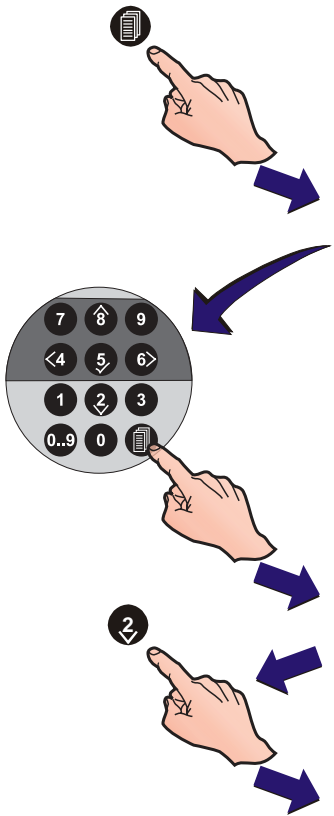

**ACCESS TO MENUS RESTRICTED**  
 Enter Level 2/3 Passcode: . . . . < : BackSp

- 2 Either turn the keyswitch or, using the numeric keypad, enter the correct Level 2 access code and confirm using the '5' button to display the menu. The LCD displays the user number ([U0] to [U9]) in the top left hand corner.

**Note:** An incorrect access code causes the LCD to display the 'ERROR - INCORRECT PASSCODE' message. After one minute the LCD returns to the 'Status: NORMAL' message.

3

**[U0] 1 : Test 2 : Disable/Enable 3 : Clock**  
**4 : View Mode 5 : Commission**

- 3 Using the numeric keypad, press the '2' button to display the DISABLE / ENABLE menu.

**[U0 Disable/Enable] 1:Zone 2:Outputs**  
**3:Day Mode 4:Delays**

### 4.9.1 Zone - User Option

This option allows the user to disable/enable a full zone or part of a zone (selected devices). To perform this operation:

- Using the numeric keypad, press the '1' button to select the Disable/Enable Zone option.

[U0 Disable/Enable] 1:Zone 2:Outputs  
3:Day Mode 4:Delays

2

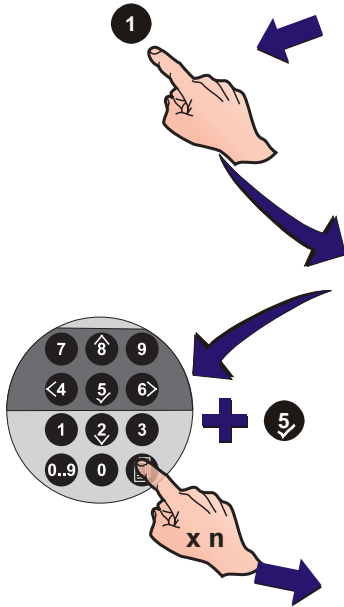

- The LCD displays the Zone option, and prompts for a zone number. Enter the zone number (one or two digits entered via the numeric keypad). Press the '5' to confirm the zone number.

[Disable/Enable] Zone \_\_  
Enter Zone Number < : Cancel

- The LCD then displays the current state of the zone (Fully enabled, Fully disabled or Part disabled) and prompts for selection of Full Zone or Devices in zone:

**Note:** Press the '2'/'8' buttons to step to the previous/next zone and confirm using '5' button.

[Disable/Enable] Zone 0 1 (Fully enabled)  
1:Full Zone 2:Device in Zone ↑ : More

- To disable:
  - A Full Zone - Press the '1' button on the numeric keypad to select the Full Zone option, and the '5' button to confirm.

4

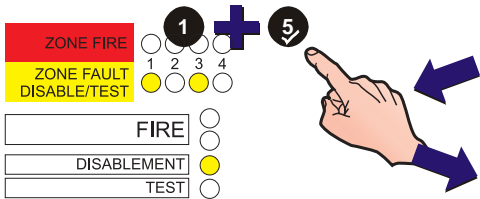

[Disable/Enable] Zone 0 1 Disable fully ?  
Press ✓ to Confirm <:Cancel

[Disable/Enable] Zone 0 1 Fully disabled  
1:Full Zone 2:Device in Zone ↑ : More

The DISABLEMENT and relevant ZONE FAULT/DISABLE/TEST LEDs illuminate, indicating that the selected zone(s) are now disabled. The LCD returns to the Disable/Enable menu.

To enable a Full Zone:

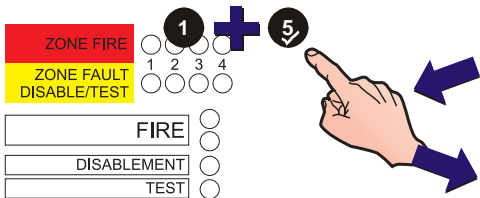

[Disable/Enable] Zone 0 1 Enable fully ?  
Press ✓ to Confirm <:Cancel

[Disable/Enable] Zone 0 1 Fully enabled  
1:Full Zone 2:Device in Zone ↑ : More

The DISABLEMENT and relevant ZONE FAULT/DISABLE/TEST LEDs extinguish.



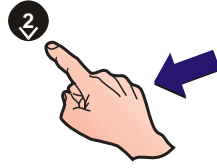

- b. A Partial Zone - Press the '2' button on the numeric keypad to select the Device in Zone option:

**[Disable/Enable] Zone 0 1      Part disabled**  
**1:Full Zone    2:Device in Zone      ↑ : More**

- 5 To select individual devices use the '2/8' buttons to display the required device(s). Confirm selection of each by pressing the '5' button.

The diagram illustrates the sequence of LCD messages and keypad actions:

- Initial State:** LCD shows "[Disable/Enable] Zone 0 1" and "Part disabled".
- Action 1:** Press '2' to select "2:Device in Zone".
- Screen 1:** "[Enable] Zone 0 1 - Enable S02 ? Press ✓ to confirm" with "<:Cancel" on the right.
- Action 2:** Press '8' to confirm.
- Screen 2:** "[Disable] Zone 0 1 - Disable S01 ? Press ✓ to confirm" with "<:Cancel" on the right.
- Action 3:** Press '2' to confirm.
- Screen 3:** "[Disable] Zone 0 1 - Disable M99 ? Press ✓ to confirm" with "<:Cancel" on the right.
- Action 4:** Press '5' to confirm.
- Keypad:** Shows "ZONE FIRE" (red), "ZONE FAULT DISABLE/TEST" (yellow), and four device LEDs (1-4). "FIRE" and "DISABLEMENT" LEDs are illuminated. A "+" sign and "5" button are also shown.

Repeat until all devices are in the required state (either disabled or enabled). The DISABLEMENT LED remains illuminated if one or more devices are disabled. It is extinguished when all devices have been enabled.

The relevant ZONE FAULT/DISABLE/TEST LED is illuminated when all devices in that zone have been disabled. Disablement of ALL devices is confirmed by the 'Fully Disabled' LCD message.

- 6 Press the '<4' button to return to the Disable/Enable menu.

### 4.9.2 Outputs - User Option

The Outputs option allows the user to disable or enable all sounders, the extinguishant system (if fitted), and relay and control outputs.

To Disable/Enable these outputs, proceed as follows:

**[U0 Disable/Enable] 1:Zone 2:Outputs  
3:Day Mode 4:Delays**

1 Using the numeric keypad, press the '2' pushbutton to display the Disable/Enable Outputs menu:

**[U0 Disable/Enable] 1:Sounders  
2:Ext. Systems 3:Others**

2 Press the appropriate numbered button on the numeric keypad to display one of the following:

a. Press the '1' button to disable/enable all sounders.

**Disable ALL Sounder Outputs  
Press ✓ to confirm <:Cancel**

b. Press the '2' button to disable/enable all Extinguishant System outputs.

**Disable ALL Extinguishant System Outputs  
Press ✓ to confirm <:Cancel**

c. Press the '3' button to disable/enable 'other' (relays and control) outputs.

**Disable ALL Relay and CTL Outputs  
Press ✓ to confirm <:Cancel**

3 Press the '5' button to confirm the selected operation. The LCD automatically returns to the Disable/Enable menu.

When outputs are disabled, the general **DISABLEMENT** LED and, if applicable, the **RELAY DISABLE** and/or **SOUNDERS DISABLED** LEDs illuminate. If the Extinguishant System is disabled, only the **DISABLEMENT** LED will illuminate.

**[U0 Disable/Enable] 1:Zone 2:Outputs  
3:Day Mode 4:Delays**

The **RELAY DISABLE** and the **SOUNDERS DISABLED** LEDs extinguish when the corresponding outputs have been enabled. The **DISABLEMENT** LED will only extinguish when ALL disablements have been enabled.

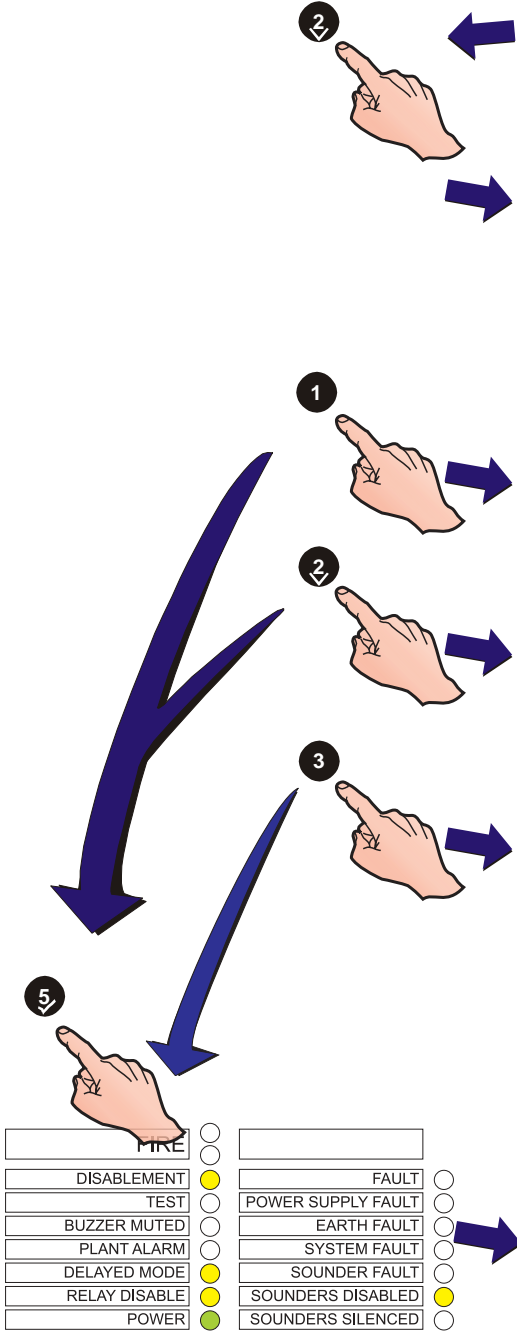

### 4.9.3 Day Mode - User Option

If Day Mode is enabled during panel commissioning, this option allows the user to activate/deactivate Day Mode delays during the set Day Mode time period. This has no effect on any sensor sensitivity changes that may have been configured during commissioning. Any sensor sensitivity changes will automatically occur at the set Day Mode period start and end times.

To Disable / Enable Day Mode, proceed as follows:

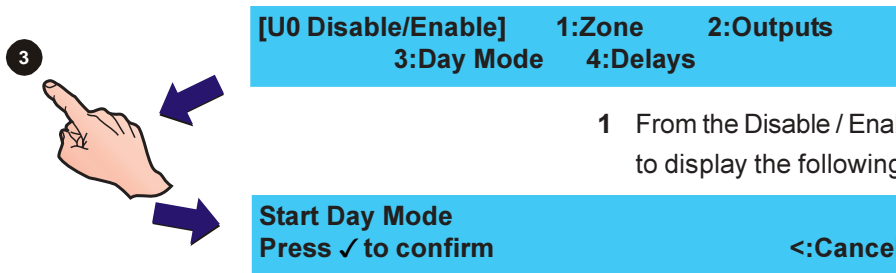

1 From the Disable / Enable menu, press the '3' button to display the following:

2 Press the '5' button to confirm the requested operation. The LCD automatically returns to the Disable / Enable menu.

If Delays have been configured the DISABLEMENT and DELAYED MODE LEDs illuminate when Day Mode is started.

FIRE	<input type="checkbox"/>
DISABLEMENT	<input checked="" type="checkbox"/>
TEST	<input type="checkbox"/>
BUZZER MUTED	<input type="checkbox"/>
PLANT ALARM	<input type="checkbox"/>
DELAYED MODE	<input checked="" type="checkbox"/>
RELAY DISABLE	<input type="checkbox"/>
POWER	<input checked="" type="checkbox"/>

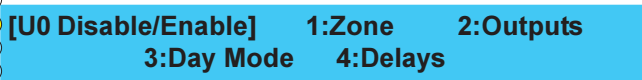

3 To end Day Mode, repeat steps 1 and 2 (the display is as shown below):

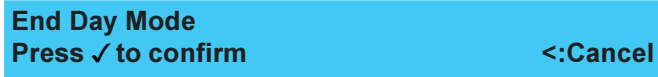

The DELAYED MODE LED will extinguish when the Day Mode operation has been ended, either when day mode is turned off or when the timer has timed out. No delays are active. The DISABLEMENT LED will extinguish provided there are no other disablements present.

**Note:** If Day Mode is NOT cancelled manually, Day Mode delays are automatically deactivated at the end of the set time period.

### 4.9.4 Delays - User Option

The Disable / Enable Delays option allows the user to cancel or initiate the Delays function of the panel, which is configured during commissioning (refer to **997-263 ID50 Series Panel Installation, Commissioning and Configuration Manual, Sections 5.5.3 Primary/Extend Delay Timers and 5.7.8 CBE Zones**).

To Disable / Enable Delays:

- Using the numeric keypad, press the '**4**' button to select the Disable/Enable Delays option:

**[U0 Disable/Enable] 1:Zone 2:Outputs  
3:Day Mode 4:Delays**

- At the prompt, press the '**5**' button to confirm the Delays operation. If delays are disabled, the LCD prompts to enable delays, and vice versa.

**Disable Delays  
Press ✓ to confirm <:Cancel**

When the delays are disabled, the **DISABLEMENT** and **DELAYED MODE** LEDs are extinguished. When the delays are enabled, both LEDs are illuminated.

**[U0 Disable/Enable] 1:Zone 2:Outputs  
3:Day Mode 4:Delays**

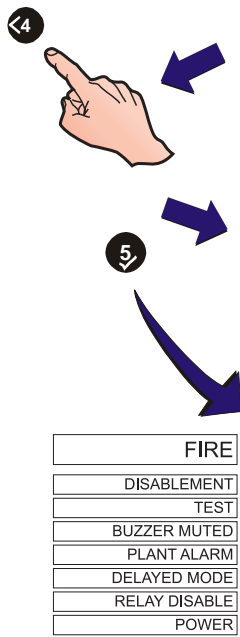

If a Day Mode time period is configured, the CBE Rule delays will activate when Day Mode is started either:

- Using the Disable / Enable menu, or
- When Digital / ÜE Input 1 is operated (if this input is configured during commissioning for Day Mode Start).

These delays will be deactivated when Day Mode is ended, either automatically at the end of the configured Day Mode period, or by one of the following:

- Using the Disable / Enable menu,
- When the Digital / ÜE Input 1 is operated,
- Delays are disabled using the Disable / Enable menu.

### 4.10 Clock - User Option

The CLOCK User Option allows the user to enter or edit the following:

- a. Time.
- b. Date.

To edit the CLOCK - User Option:

- 1 At the 'Status: NORMAL' message, press the '📄' button. The LCD prompts for a Level 2/3 access code.

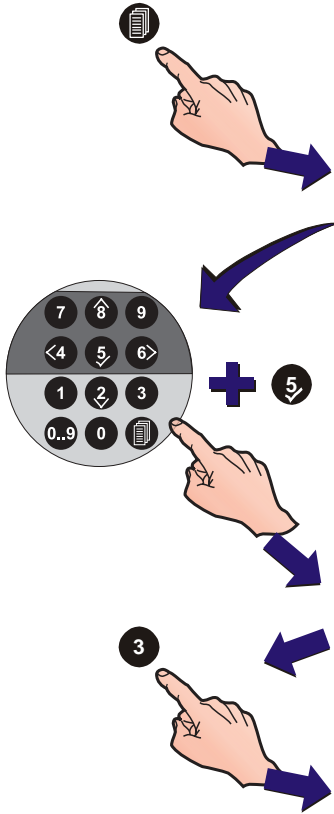

**ACCESS TO MENUS RESTRICTED**  
 Enter Level 2/3 Passcode: . . . . < : BackSp

**Note:** If an incorrect access code is entered, the LCD displays an 'ERROR - INCORRECT PASSCODE !!!'. After one minute the LCD returns to the 'Status: NORMAL' message.

- 2 Either turn the keyswitch or, using the numeric keypad, enter the correct Level 2 access code and confirm using the '5' button. The Level 2 menu is displayed with the user number ([U0] to [U9]) in the top left-hand corner.

**[U0] 1 : Test 2 : Disable/Enable 3 : Clock**  
**4 : View Mode 5 : Commission**

- 3 Press the '3' button on the numeric keypad to select the Clock menu.

**[U0 Clock] 1 : Time 2 : Date**

### 4.10.1 Time - User Option

The Time User Option allows the user to enter or edit the current time displayed on the LCD. To edit the time, proceed as follows:

- 1 Press the '1' pushbutton on the numeric keypad to select the Time option.

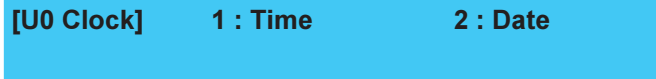

- 2 The LCD displays the Enter New Time prompt. Using the numeric keypad, enter the numbers directly. All digits are automatically entered into position from left to right on the display.

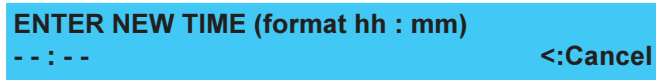

After entering the last digit, press the '5' to confirm and return to the CLOCK menu.

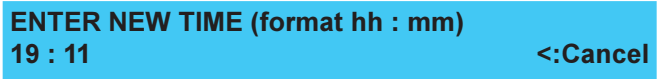
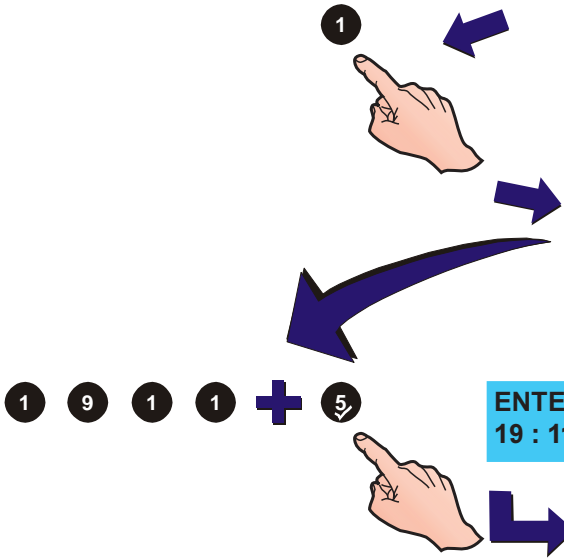

**Note:** The entered time must be in the 24-hour clock format (e.g. for 07:11 pm, enter 1911).

If an invalid time is entered, the LCD displays an error message and then re-displays the Clock menu.

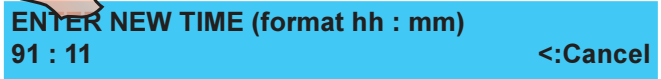
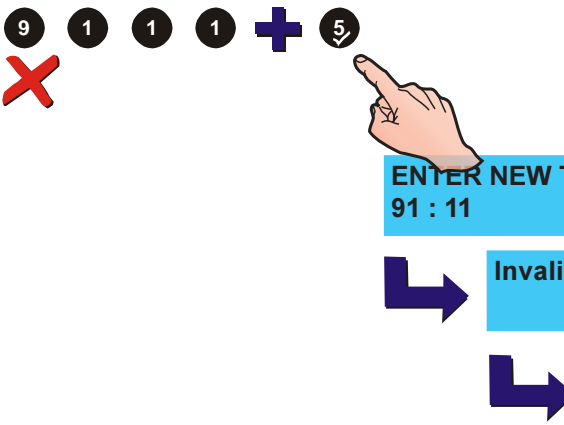

### 4.10.2 Date - User Option

The Date User Option allows the user to enter or edit the current date displayed on the LCD. To enter or edit the date, proceed as follows:

- Using the numeric keypad, press the '2' button to select the Date option.

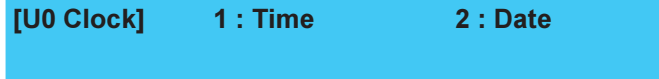

- The LCD prompts for entry of a new date. Using the numeric keypad, enter the numbers directly. All digits are automatically entered into position from left to right on the display.

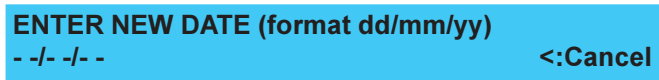

After entering the last digit press the '5' to confirm and return to the Clock menu.

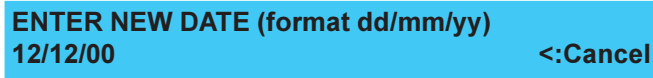
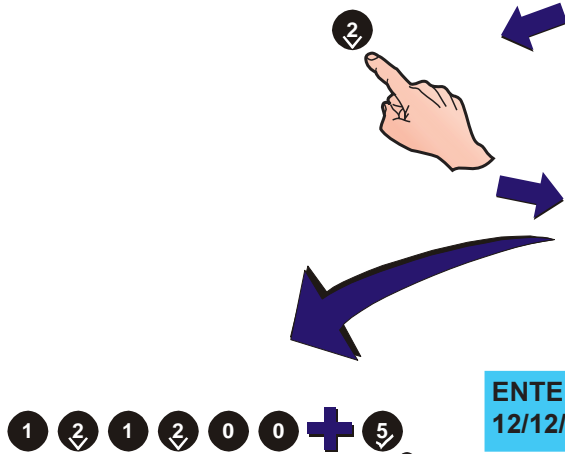

**Note:** The date must be entered in the format dd/mm/yy. Only date entries between 2000 and 2063 are valid.

If an invalid date is entered, for example 222222 - 22/22/22, the LCD displays an error message and then re-displays the Clock menu.

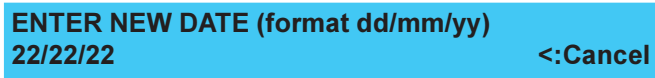
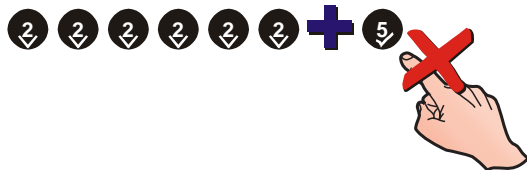

## 4.11 View Mode - User Option

The VIEW MODE User Option allows the user to view the following system parameters:

- Log
- Devices on the loop
- Faults
- Input Events
- Disabling on the loop
- Alarm Count
- Voltages
- Version (system and loop software).

To display the View Mode menu:

- From the 'Status: NORMAL' message, press the '📄' button. The LCD prompts for a Level 2/3 access code.

**ACCESS TO MENUS RESTRICTED**  
Enter Level 2/3 Passcode: . . . . < : BackSp

**Note:** If an incorrect access code is entered, the LCD displays 'ERROR - INCORRECT PASSCODE !!!'. After one minute the LCD returns to the 'Status: NORMAL' message.

- Using the numeric keypad, enter the correct Level 2 access code and confirm using the '5' button. The Level 2 menu is displayed with the user number ([U0] to [U9]) in the top left-hand corner.

**[U0] 1 : Test 2 : Disable/Enable 3 : Clock**  
**4 : View Mode 5 : Commission**

- Using the numeric keypad, press the '<4' button to select the View Mode menu:

**[U0 View] 1:Log 2:Devices 3:Faults**  
**4:Input Events 5:Disabled ↑ : More**

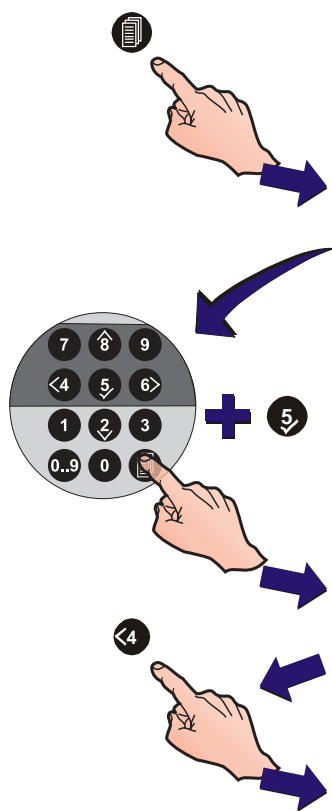



### 4.11.1 Log - User Option

The Log User Option allows the user to view all logged events, one at a time. To display the Log, from the VIEW Mode menu:

- 1 On the numeric keypad, press the '1' pushbutton to select the Log option.

[U0 View] 1:Log 2:Devices 3:Faults  
4:Input Events 5:Disabled ↕ : More

- 2 The LCD automatically displays the last recorded event. Viewing commences from this point; press the '2'/'8' buttons to scroll through the Log entries. Example Log entries are given below:

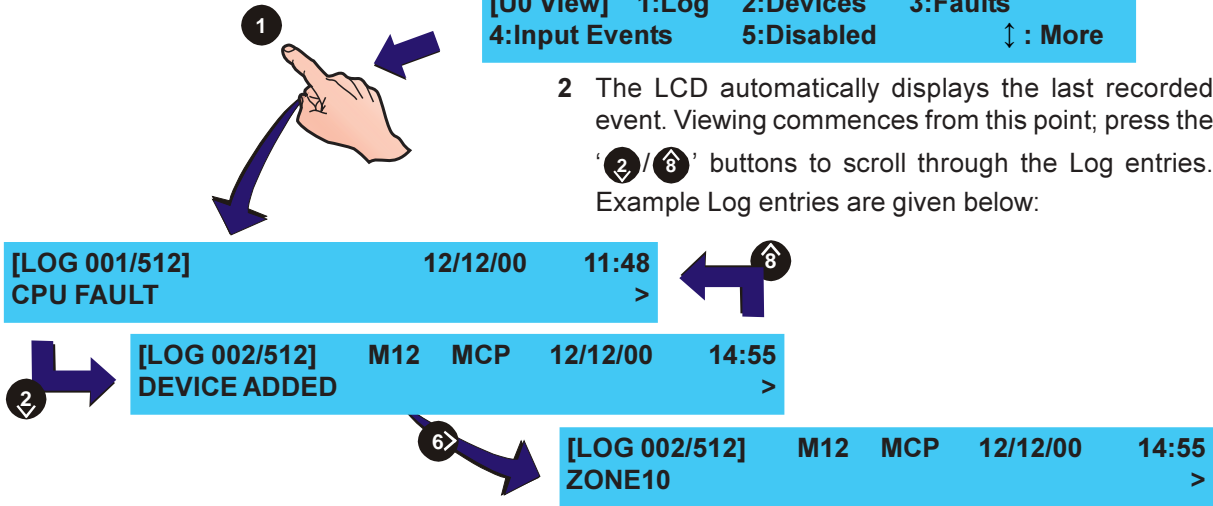

**Note:** Press the '6' button to view additional zone text information. To return to the previous display press any numeric/cursor key. Alternatively, if no key is pressed within ten (10) seconds the LCD returns to the View Log display automatically.

- 3 Press the '<4' pushbutton to return to the View Mode menu.

### 4.11.2 Devices - User Option

The Devices User Option allows the user to observe all loop devices in turn. To view Devices, from the View Mode menu:

- 1 On the numeric keypad, press the '**2**' button to select the Devices display.

**[U0 View] 1:Log 2:Devices 3:Faults**  
**4:Input Events 5:Disabled ↑ : More**

- 2 The LCD automatically displays the lowest occupied sensor address. Press the '**2**'/'**8**' buttons to scroll through device address entries.

**[U0 Sensor 01] Type OPT - Level 050%**  
**PW1:286 2:283 3:285 4:1003 5:0292 <:Exit**

**Note:** The percentage value is the device's sensitivity level e.g. 100% (default) is equivalent to alarm.

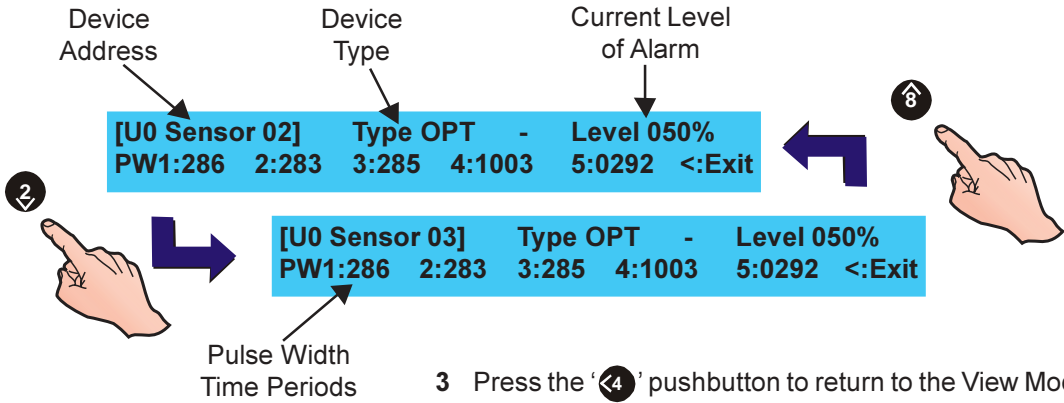

- 3 Press the '**4**' pushbutton to return to the View Mode menu.

### 4.11.3 Faults - User Option

This menu option allows the user to view active faults while the normal active fault display has been overridden by a higher priority display (alarms). To view Faults, from the View Mode menu:

- 1 On the numeric keypad, press the '3' button to select the Faults display.

[U0 View] 1:Log 2:Devices 3:Faults  
4:Input Events 5:Disabled ↑ : More

- 2 The LCD automatically displays the last recorded event first. Viewing commences from this point. Press the '2'/'8' buttons to scroll through the faults.

**Note:** Press the '6' button to view additional zone text information. To return to the fault message press any numeric/cursor key. Alternatively, if no key is pressed within ten (10) seconds the display reverts to the fault message. Example fault displays are given below:

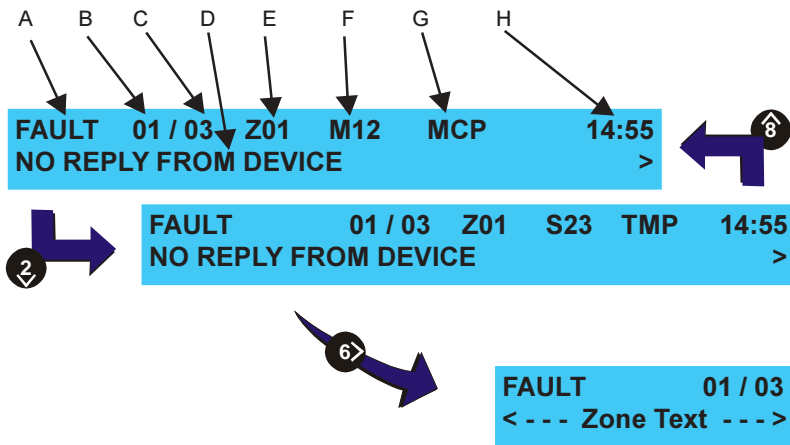

- a. Fault condition
- b. Fault currently displayed.
- c. Total number of faults logged.
- d. Text description of fault.
- e. Zone Number.
- f. Device Address.
- g. Device Type.
- h. Time fault was logged.

**Note:** If no faults are recorded on the system, the following message is displayed:

The system has NO faults present <:Exit

- 3 Press the '<4' button to return to the View Mode menu.

### 4.11.4 Input Events - User Option

The Input Events menu option allows the user to view active input events/plant alarms while the normal active input events/plant alarms display has been overridden by a higher priority display (alarms). To view Plant Alarms, from the VIEW Mode menu:

- Using the numeric keypad, press the '**4**' button to select the Input Events display.



- The LCD automatically displays either:
  - The first input event, or

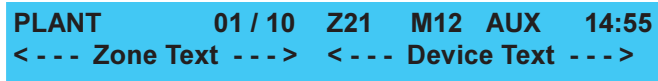

- The 'No Warnings message', if there are no current input events recorded on the system.

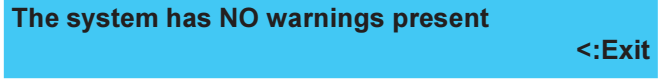

- If a number of input events are present, press the '**2**' / '**8**' buttons to scroll through the entries:

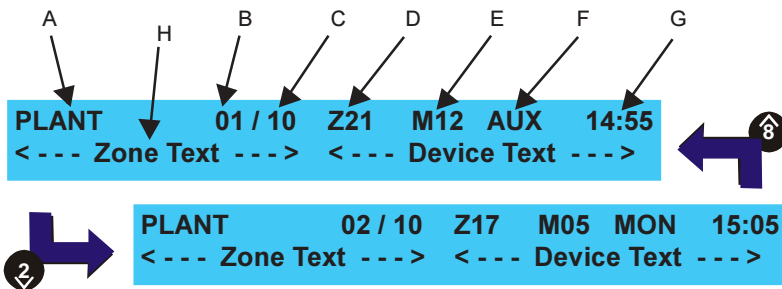

- Plant Alarm condition
- Alarm currently displayed.
- Number of alarms.
- Zone Number.
- Device Address.
- Device Type.
- Time alarm was logged.
- Zonal and Device text (if any).

- Press the '**4**' button to return to the View Mode menu.

### 4.11.5 Disabled - User Option

The Disablement User Option allows the user to view all current loop-based input disablements recorded on the system. To view each disablement in turn, from the VIEW Mode menu:

- Using the numeric keypad, press the '5' button to select the Disablements display.

[U0 View] 1:Log 2:Devices 3:Faults  
4:Input Events 5:Disabled ↑ : More

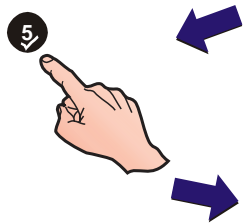

- The LCD automatically displays either:
  - The zone disablements, or

DISABLEMENT 01 / 01 Z01 S02 TMP  
< --- Zone Text --- > < --- Device Text --- >

- The NO disablements message, if no current Disablements are present on the system.

There are no loop devices disabled <:Exit

- If more than one disablement is present, press the '2'/'8' buttons to scroll through the Disablement entries (see examples below):

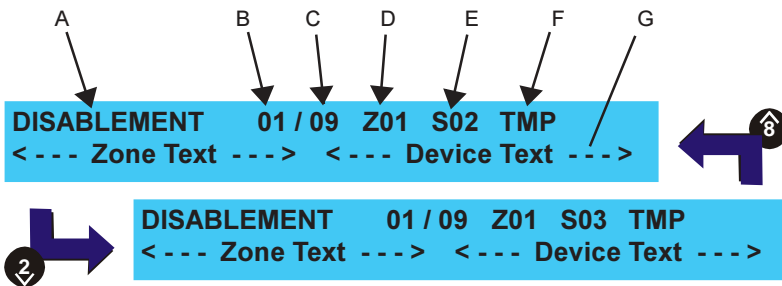

- Condition,
- Disablement currently displayed,
- Active disablements,
- Zone number,
- Device address,
- Device type,
- Zonal and device text (if any).

- Press the '<4' button to return to the View Mode menu.

### 4.11.6 Alarm Count - User Option

The Alarm Count User Option allows the user to view the number of times the panel has entered alarm condition since manufacture. To view the Alarm Count, from the VIEW Mode menu:

- Using the numeric keypad, press the '6' button to select the Alarm Count display.

[U0 View] 6:Alarm Count 7:Voltages  
8:Versions ↑ : More

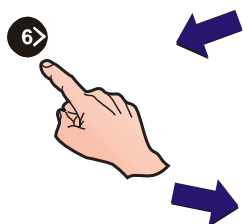

- The LCD displays the Alarm Count. Press the '<4' button to return to the View Mode menu.

Current Alarm Count is 12 <:Exit

### 4.11.7 Voltages - User Option

The Voltages User Option allows the user to view the Voltages of various parts of the system. To view these Voltages, from the View Mode menu:

- Using the numeric keypad, press the '7' button to select the Voltages menu.

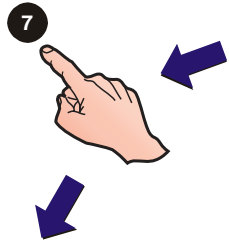

[U0 View] 6:Alarm Count 7:Voltages  
8:Versions ↑ : More

- The Battery Volts window is automatically displayed. Press the '2'/'8' buttons to display the previous/next system voltage.

[U0 VOLTS] BATTERY VOLTS = 27.0  
↑ : Select <:Cancel

[U0 ANALOGUE] EARTH = 271  
↑ : Select <:Cancel

[U0 ANALOGUE] SOUNDER 1 = 164

[U0 ANALOGUE] SOUNDER 2 = 164

[U0 ANALOGUE] SOUNDER 3 = 164

[U0 ANALOGUE] SOUNDER 4 = 164

[U0 VOLTS] AC POWER = 237

[U0 VOLTS] CHARGER = 27.2  
↑ : Select <:Cancel

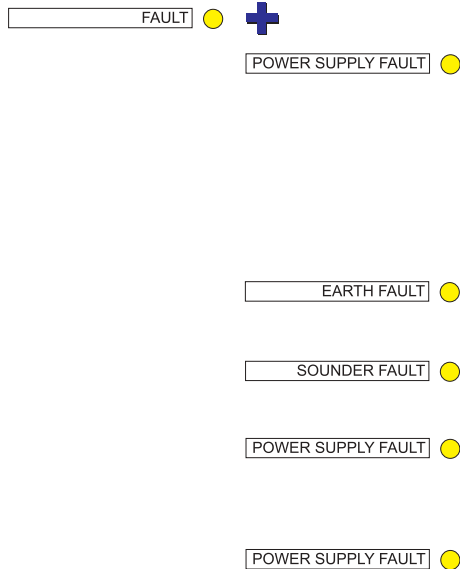

**Note:** The voltage displayed for each system should be within a given range.

- Mains supply present: a battery voltage value greater than 15V means that batteries are connected; battery voltage is low if greater than 15V but less than 18.9V.  
No mains supply present: a value of less than 22V means an imminent deep discharge; a value less than 21V indicates deep discharge of the batteries.
- An Earth Fault is indicated when the displayed value is less than 175 or greater than 450.
- A Sounder is open circuit if the displayed value is below 75, or short circuit if above 250.
- A mains failure is detected when the AC voltage drops below 193Vac. This fault will remain until the AC voltage rises above 205Vac.
- The Charger is faulty if a value less than 24V is displayed.

- Press the '<4' button to cancel and return to the View Mode menu.

### 4.11.8 Version - User Option

The Version User Option allows the user to view the System and Loop part numbers and revision levels used in the system. To view the Versions, from the View Mode menu:

- 1 Using the numeric keypad, press the '8' button to select the Versions display.

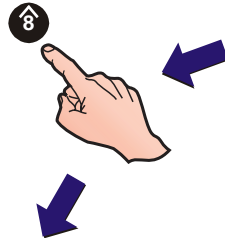

[U0 View] 6:Alarm Count 7:Voltages  
8:Versions ↓ : More

- 2 The LCD automatically displays the following. Press the '<' button to cancel and return to the View Mode menu.

[U0 VERSION] System : nnn-**nnn**-nnn n.nn  
Loop : nnn-**nnn** n.nn

Revision Level

Part Number

### 4.12 Commissioning

The Commissioning User Option is available to Level 3 users only (i.e. the Level 3 access code must be entered). The Commissioning menu allows the engineer to configure the system in preparation for handover.

For details concerning commissioning and configuring the system, refer to **997-263, ID50 Series Panel - Installation, Commissioning & Configuration Manual, Sections 4 and 5.**





## Appendix 1 - Log Book

In accordance with EN54 part 14, it is the user's responsibility to maintain a log book and to record all events resulting from or affecting the system. The log book should be kept in a place accessible to authorised persons (preferably near the control panel).

One or more identifiable individuals should be appointed to oversee or carry out all entries in the log book. The names of these persons (and any changes of responsible person) should be recorded.

All events should be properly recorded (events include real and false fire alarms, faults, pre-alarm warnings, tests, temporary disconnections and service visits). A brief note of any work carried out or outstanding should be made.

Sample pages of the log book are provided here and can be photocopied to produce a log book that conforms to EN54-14. The sample below is for the reference data (eg the name of the responsible person), while the sample on the next page is for the entry of event data.

REFERENCE DATA	
Name and address -----	
Responsible person -----	
-----	Date -----
-----	Date -----
-----	Date -----
-----	Date -----
-----	Date -----
-----	Date -----
-----	Date -----
-----	Date -----
-----	Date -----
-----	Date -----
-----	Date -----
-----	Date -----
This system was installed by -----	
and is maintained under contract by	
-----	until -----
Telephone number -----	
should be contacted if service is required	







## Appendix 2 - Maintenance

Create a log book (see **Appendix 1**) in accordance with the recommendations of EN54 Part 14. This log book should be used and maintained for recording events as described below.

### A2.1 Routine Testing

In order to ensure that the system is fully operational, and to comply with the requirements of EN54 Part 14 and BS 5839 Part 1: 1988, the following routine attention is recommended:

**Daily** - Check the panel to ascertain that it indicates normal operation. If any fault is indicated check that it has been recorded in the log book and that the appropriate actions have been taken, e.g. informing the maintaining company.

**Weekly** - Test at least one sensor or call point to confirm the operation of the panel and the audible alarms. Test a different zone each week and, if possible, a different device. Keep a record of the device and zone tested each week. Record and report any malfunction.

**Quarterly** - The responsible person should ensure that every three months the system is checked by a competent person who shall:

Check the log book entries and any action taken.

Check the standby batteries and the charger voltage.

Test at least one device in each zone to check the panel functions.

Check the operation of the audible alarm and any link to a remote manned centre, Central Station, etc.

Carry out a visual inspection of the installation to check for alterations or obstructions and issue a certificate of testing.

**Annually** - The responsible person should ensure that, in addition to the quarterly checks, each device on the system is tested and that a visual inspection is made of the cable fittings and equipment.

### A2.2 Batteries

As a minimum, replace the batteries every four years.

The battery units should always be disposed of in accordance with the battery manufacturer's recommendations and local regulations.

### A2.3 Cleaning

The panel may be cleaned periodically by wiping with a soft, damp lint-free cloth. **Do not** use any solvents.





## Appendix 3

### ID60 Single Loop Panel Differences

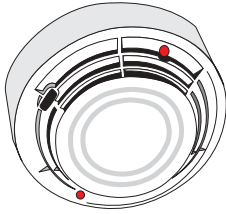

The **ID60 Panel** differs from the **ID50 Panel** in that it supports Very Intelligent Early Warning (VIEW™) sensors. This appendix describes differences to the user operations required by the **ID60 Panel**.

Each VIEW™ sensor has to be calibrated on first operation with the panel. If a VIEW™ sensor is removed and cleaned, or replaced with a new one, wait at least 30 secs after removal before replacing it.

Calibration is carried out automatically for each sensor approximately 60 secs after the sensor is installed on a panel which is already operating normally.

During this initial period (which is required to allow the VIEW™ sensor to stabilise) the sensor must not be exposed to smoke or any other abnormal conditions, otherwise the panel may report a sensor fault.



**VIEW™ sensors remain inoperable for 60 seconds after being replaced while calibrating**



Charles Avenue  
Burgess Hill  
W. Sussex  
RH15 9UF

T: +44 (0) 1444 230 300  
F: +44 (0) 1444 230 888  
E: sales@notifier.ltd.uk  
www.notifier.ltd.uk

local distributor



Every care has been taken in the preparation of this document but no liability can be accepted for the use of the information therein. Design features may be changed or amended without prior notice.

