



IDR

997-411-000-9, Issue 9 March 2008

**-2P, -2A & -6A
repeaters user
manual**

Quick Contents Reference by Section

INTRODUCTION -
SEE SECTION 1

INSTALLATION -
SEE SECTION 2

OPERATION - SEE SECTION 4

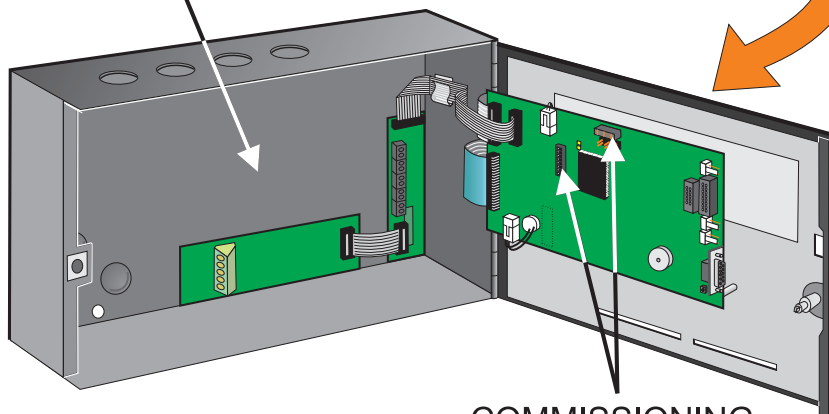
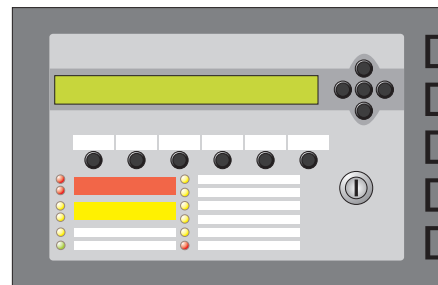

COMMISSIONING -
SEE SECTION 3

ALSO:

SPECIFICATION - SEE APPENDIX 1

BATTERY CALCULATIONS - SEE APPENDIX 2

IDR-6A REPEATER LIMITATIONS - SEE APPENDIX 3

Contents

1	Introduction	1
1.1	CE Marking	2
1.2	System Design and Planning	2
1.3	General	2
1.4	Related Documents	3
1.5	Warnings and Cautions	3
1.6	Tips	3
2	Installation Guide	4
2.1	Pre-Installation Check List	4
	2.1.1 <i>Some DO's and DON'T's</i>	4
2.2	Transient Protection	5
2.3	Installation	6
	2.3.1 <i>Checking Your Repeater for Damage</i>	6
	2.3.2 <i>What to do if Your Repeater is Damaged or Suspect</i>	7
2.4	Installation Options	8
2.5	Installing the Enclosure	9
	2.5.1 <i>Fixing Enclosure to Wall</i>	9
	2.5.2 <i>Fitting the Label Inserts</i>	10
2.6	Isolated RS232 Board (option)	11
2.7	Bezel Kit (option)	12
2.8	Installing the Wiring	13
	2.8.1 <i>External Wiring Connections</i>	13
	2.8.2 <i>RS485 Serial Network - Address Switches and Termination Resistors</i>	14
	2.8.3 <i>ID²net Network via RS232 - Address Switches</i>	15
3	Commissioning	16
3.1	Preliminary Checks	16
3.2	Powering the Repeater	17
3.3	Passive Repeaters	17
4	Operation	18
4.1	Controls and Indicators	18
4.2	Menus - General Information	20
4.3	Menus: -2A/-2P (Except ID50)	21
	4.3.1 <i>Lamp Test (-2A)</i>	21

4.3.2	<i>Power Diagnostics (-2A)</i>	21
4.3.3	<i>Pushbutton Test (-2A)</i>	22
4.3.4	<i>Edit NORMAL Message (-2A)</i>	23
4.3.5	<i>Restore NORMAL Message (-2A)</i>	23
4.3.6	<i>Language (-2A)</i>	23
4.3.7	<i>Mute Buzzer (-2P)</i>	24
4.3.8	<i>Cancel (-2A/-2P)</i>	24
4.4	Menus: -2A/-2P (ID50 Only)	24
4.4.1	<i>Mute Buzzer (-2P)</i>	24
4.4.2	<i>LEDs/LCD/Buzzer Test (ID50 -2A/-2P)</i>	25
4.4.3	<i>Pushbutton Test (ID50 -2A)</i>	25
4.4.4	<i>Log (ID50 -2A/-2P)</i>	25
4.4.5	<i>Edit NORMAL Message (ID50 -2A)</i>	26
4.4.6	<i>Language (ID50 -2A)</i>	26
4.4.7	<i>Cancel (ID50 -2A/-2P)</i>	26
4.5	Menus: -6A	27
4.5.1	<i>Test (-6A)</i>	27
4.5.1.1	Lamp Test	27
4.5.1.2	Keypad Test	28
4.5.1.3	Cancel	28
4.5.2	<i>Display Event Log (-6A)</i>	29
4.5.3	<i>Configuration (-6A)</i>	29
4.5.3.1	Set Language	29
4.5.3.2	Set Function	30
4.5.3.3	Access Level for MUTE BUZZER	30
4.5.3.4	Silence/Resound Pushbutton Function	31
4.5.3.5	Event Options	31
4.5.3.6	Technical Alarm LED	31
4.5.3.7	Disablement LED	32
4.5.3.8	Network	32
	Appendix 1 - Specification	A1 - 1
	Appendix 2 - Battery Calculations	A2 - 1
	Appendix 3 - IDR-6A Repeater Limitations	A3 - 1

1 Introduction

This manual provides the user with all necessary instructions for the installation, commissioning and operation of an IDR repeater.

There are three variants of the IDR repeater:

- a. IDR-2P passive repeater, with a 2 line x 40 character LCD.
- b. IDR-2A active repeater, with a 2 line x 40 character LCD.
- c. IDR-6A active repeater, with a 6 line x 40 character LCD.

Procedures described in this manual include appropriate warnings and cautions to guide the user towards adopting safe and methodical work practices during the installation, commissioning and operational phases.

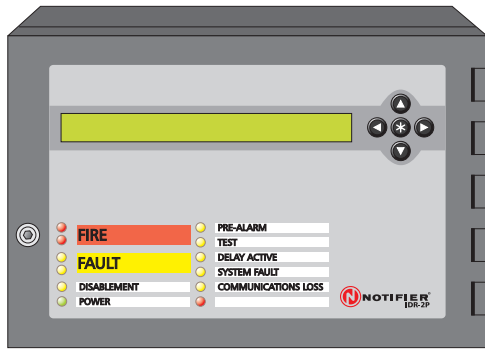

IDR-2P

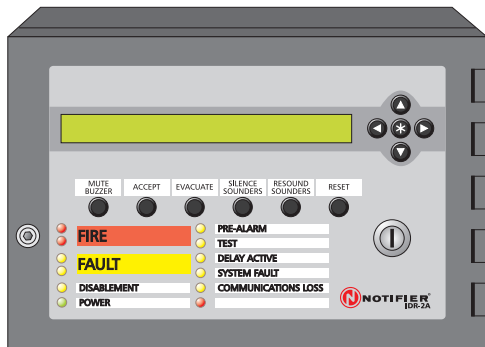

IDR-2A

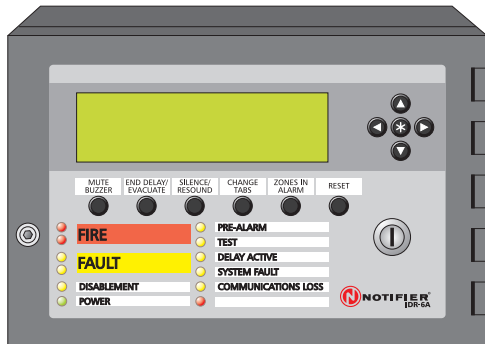

IDR-6A



Important Note

This manual must be read, and its content clearly understood, before proceeding with any work relating to the IDR repeater. Damage to the repeater and/or the fire control panel(s) may result from NOT following the recommended procedures described in this manual.

If there are any areas of doubt, consult your supplier **before** continuing with the system installation or commissioning.



1.1 CE Marking

The repeater is CE-Marked to show that it conforms to the requirements of the following European Community Directives:

- Electromagnetic Compatibility Directive 89/336/EEC (and the amending Directives 92/31/EEC and 93/68/EEC).

1.2 System Design and Planning

It is assumed that the system, of which the IDR repeater is a part, has been designed by a competent fire alarm system designer in accordance with the requirements of EN54 Part 14 and any other local codes of practice that are applicable.

1.3 General

The IDR repeater has been designed to comply with the requirements of EN54 Part 2, 1997 when used as a secondary display.

The connection between repeaters and fire control panels can be made either by an RS485 link or by an RS232 link (an optional Isolated RS232 port can be fitted to allow connection of Notifier-approved equipment).

Installation

The IDR repeaters are easy to install providing the recommended procedures described in this manual are followed. To avoid inadvertent contamination of the PCB assemblies, the manufacturer recommends that the enclosure front door be covered during installation. An optional Bezel kit containing a back box and bezel is available for pre-installation, if required.

Commissioning

To commission the IDR repeaters follow the recommended procedures described in this manual.

Some fire control panels may require configuration to associate the repeater with a specific panel on the RS485 network; the repeater then repeats that panel. Refer to the documentation supplied with the fire control panel for details of how to do this.

Operating

In addition to the repeat display of the fire control panel, the IDR repeater includes some repeater-unique menus to test the repeater operation.



Cover the enclosure front door during installation, to protect the LCD and the printed circuit board

1.4 Related Documents

This manual only describes the IDR repeater. Refer to the documentation supplied with the fire control panel for information about that panel.

1.5 Warnings and Cautions

Where appropriate, this manual includes advisory warnings and cautions to remind you to consider safety at all times, especially when following the procedures given herein. An example is shown at left.

You are alerted to any areas where there may be a risk of damage to static-sensitive devices if the recommended procedures described in this manual are not followed.

An example of an anti-static caution is provided to the left of this paragraph.

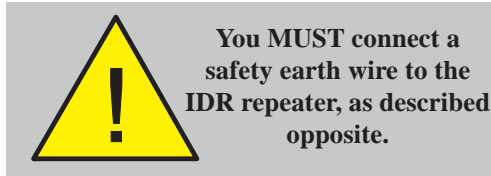

1.6 Tips

'Handy tips' are included, where appropriate, to assist you in following quick and safe procedures for system installation and integration. Look for the 'TIP!' icon and supporting text, typically illustrated at left.

2 Installation Guide

This Installation Guide provides simple guidelines on how to install an IDR repeater quickly and safely.

2.1 Pre-installation Check List

Before installing the IDR repeater you must ensure that the following criteria have been met. Failure to do this may not only result in damage to the equipment, but may also cause problems when commissioning the equipment or may adversely affect its performance.

2.1.1 Some *DO's* and *DON'T's*

Before selecting a location for the IDR repeater, **DO** make sure that:

- a. The operating ambient temperature is in the recommended range:

+5°C to +35°C and

- b. The relative humidity is between:

5% and 95%

- c. The IDR repeater is wall mounted in a position which allows clear visibility of displays and easy access to operating controls. The height above floor level should be chosen such that the LCD is just above normal eye level (approximately 1.5 metres).

- d. **DO NOT** locate the IDR repeater where it is exposed to high levels of moisture.

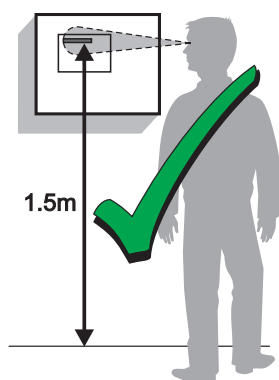
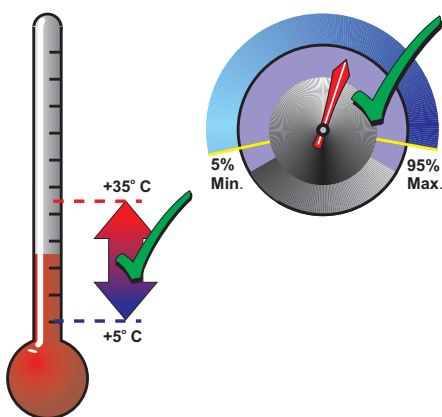

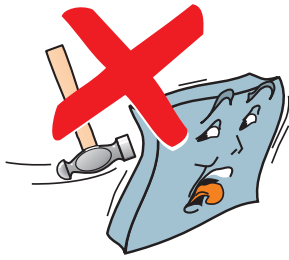

e. DO NOT locate the IDR repeater where there are high levels of vibration or shock.

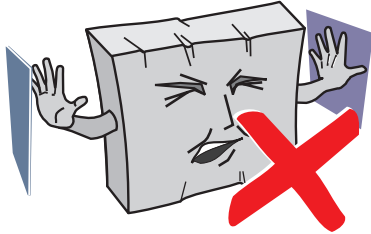

f. DO NOT site the IDR repeater where there would be restricted access to the internal equipment and cabling/wiring connections.

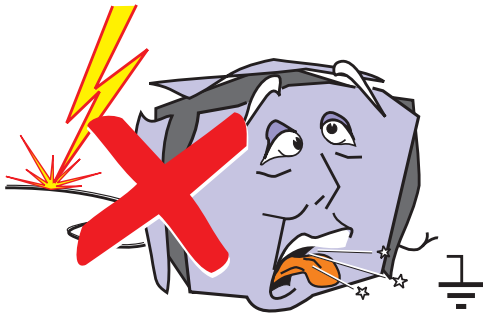

2.2 Transient Protection

This equipment contains transient-protection devices. Although no system is completely immune from lightning transients and interference, for these devices to function correctly, and to reduce susceptibility, this equipment **must** be earthed correctly.

As with all solid state devices, this system may operate erratically or can be damaged if subjected to lightning-induced transients.

The use of overhead or outside aerial wiring is not recommended due to the increased susceptibility to nearby lightning strikes.

2.3 Installation

The IDR repeater is relatively simple to install providing the recommended procedures described in this Installation Guide are followed.

Follow all installation instructions described in this manual. These instructions must be understood and the manufacturer's recommendations followed to avoid damage to the IDR repeater, the fire control panel and associated equipment.



2.3.1 Checking Your Repeater for Damage

It is important to check all supplied equipment for damage before proceeding with the installation!

Before attempting to install your IDR repeater, you should do the following:

- 1 After removing the IDR repeater from its packaging, and before you proceed with installing it in its chosen location, check for any damage that may have been caused while in transit.

Note: In the unlikely event that the IDR repeater supplied has been damaged, you **MUST NOT** install it but return it to your supplier. The procedure for returning faulty items is described in **Section 2.3.2, What to do if Your Repeater is Damaged or Suspect.**

- 2 If you are satisfied that the IDR repeater has NOT been damaged you can now commence the installation procedure. This manual describes the recommended installation methods of the IDR repeater. Refer to the relevant sections that apply to your configuration requirements.

To prevent unnecessary damage to the electronic components, place a cover over the front door while you fit the enclosure to the wall. Refer to **Section 2.5.1, Fixing Enclosure to Wall** for details.

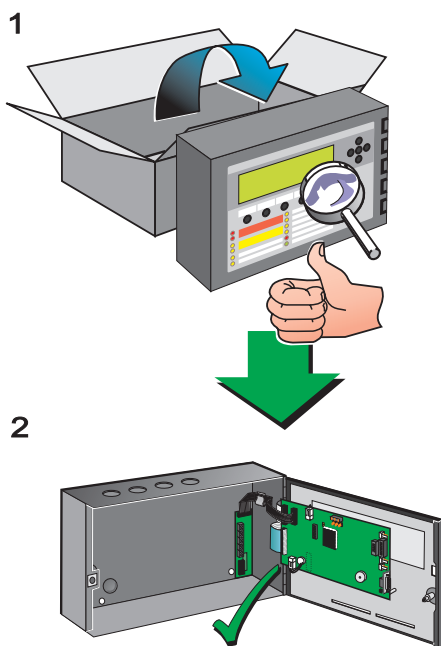

2.3.2 What to do if Your Repeater is Damaged or Suspect

If you have problems regarding the quality of any supplied order items including the IDR repeater or this manual, or items are missing, follow the procedure below:

- 1 DO NOT continue with the installation but contact your supplier for advice on what to do next.

Similarly, if the product is found to be faulty during installation contact your supplier immediately.

- 2 To aid your supplier and the manufacturer, you are requested to note all the details relevant to your complaint, date of receipt, packaging condition, etc. and forward this to your supplier.

- 3 Where the product needs to be returned to your supplier, you are requested to use the original packaging wherever possible.

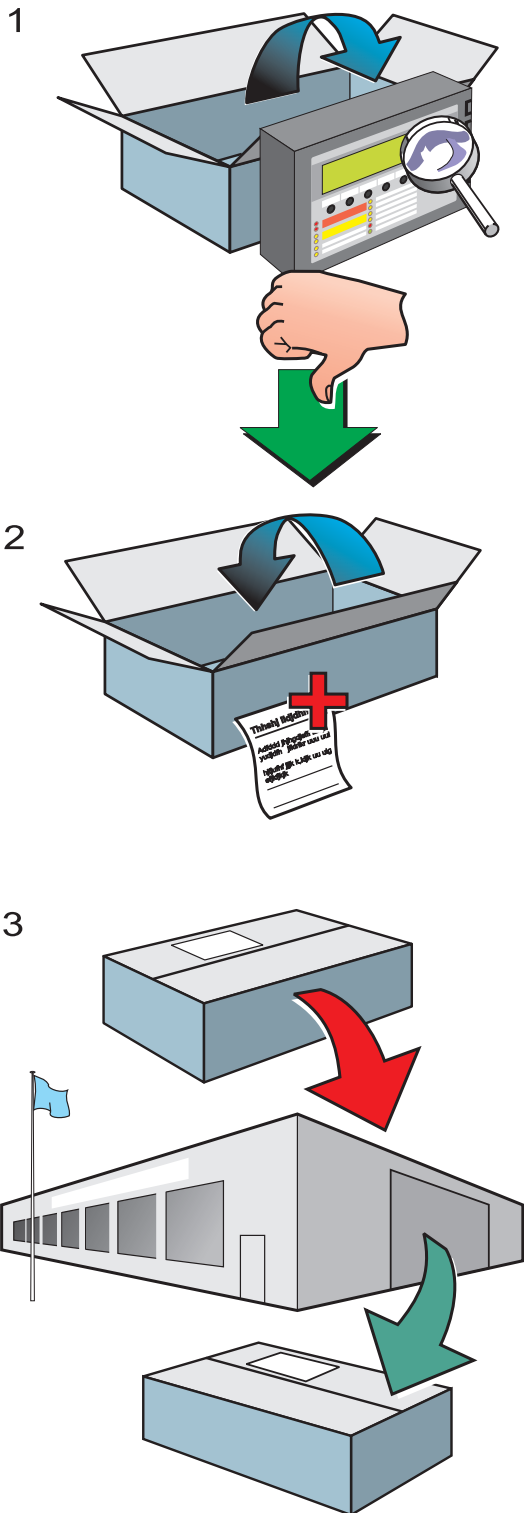

2.4 Installation Options

Installation of the IDR repeater is described in **Section 2.5**. The available options are described as follows:

- a. RS232 Board - **Section 2.6**. This allows Notifier-approved equipment to be connected to the IDR repeater.
- b. Bezel Kit - **Section 2.7**. This allows the IDR repeater to be flush-mounted.

Wiring requirements are described in **Section 2.8**.

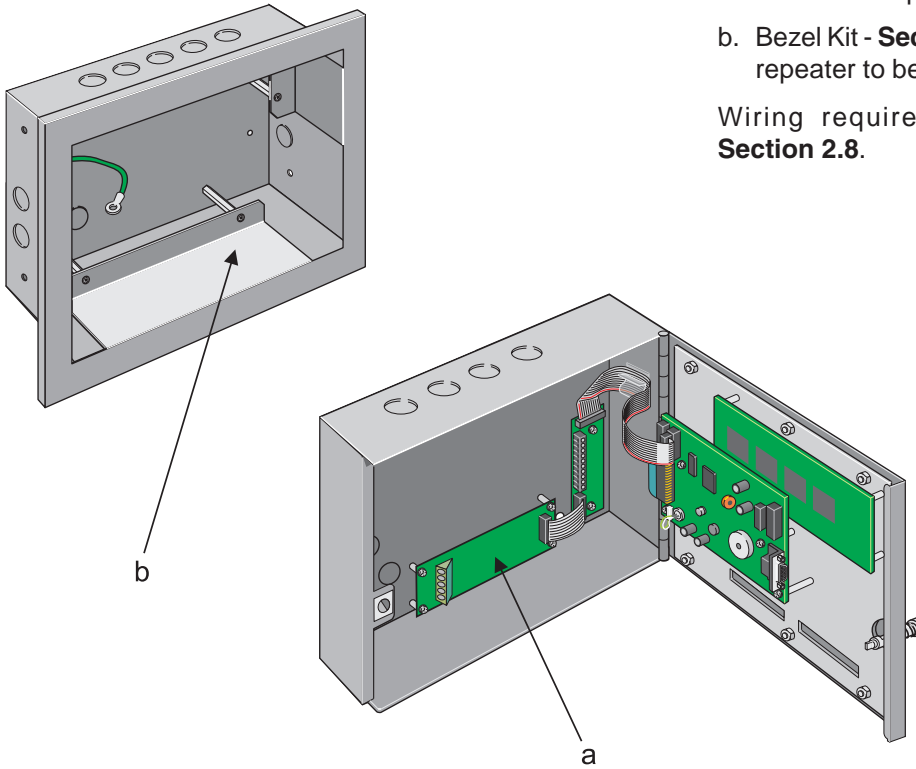

2.5 Installing the Enclosure



To ensure that the IDR repeater electronics remain clean and undamaged, it is recommended that the front door of the enclosure be covered before the enclosure is fixed to the wall. It is further recommended that the cover remain in place while other trades (e.g. plasterers or decorators) are working in the vicinity, until the IDR repeater is ready for commissioning.

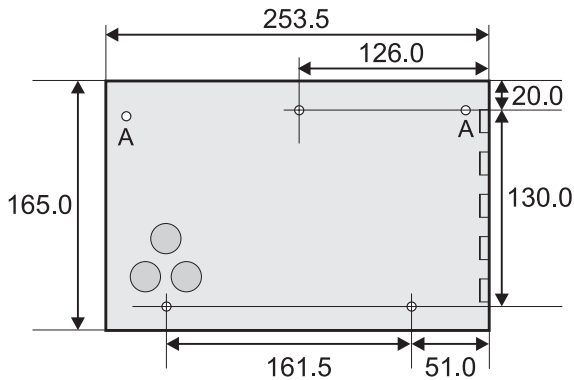

2.5.1 Fixing Enclosure to Wall

The drawing at left shows the IDR repeater enclosure fixing dimensions in millimetres. Fixing hole diameters are 5mm.

Note: The two holes 'A' on the drawing are provided for the bezel (**Section 2.7**).

Wall flatness

To prevent distortion, the IDR repeater enclosure **must** be installed on a mounting surface that is as flat as possible. If the wall is not flat where the enclosure is to be fitted, use appropriate packing pieces to level it up.

Procedure

On the suitable mounting surface:

- 1 Mark the position of the fixing holes.
- 2 Using an appropriate sized drilling bit, drill and plug three holes in the mounting surface.
- 3 Prepare apertures (20mm knockouts) required for cable access.
- 4 Using three 5mm sized screws, fix the enclosure to the mounting surface. Do not use countersunk-headed screws.

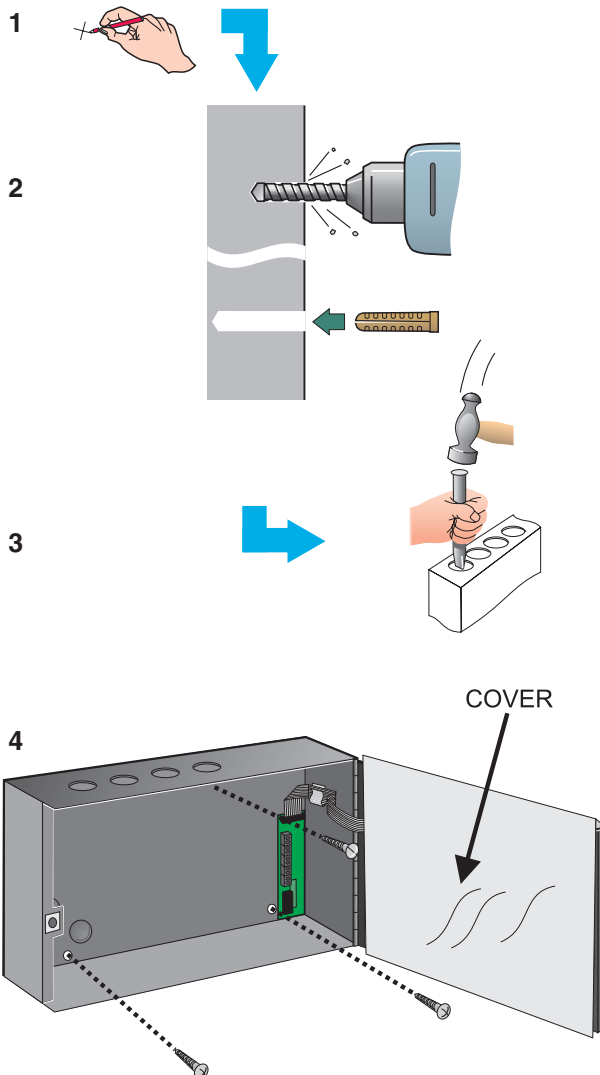

2.5.2 Fitting the Label Inserts

With the IDR repeater door open and all power disconnected, fit the label inserts as follows:

- 1
 - a. IDR-2A used with ID50 panel only. Fold the IDR-2A pushbutton legends (345-429) at the perforated line. Insert the legends into the right-hand slot (see arrow '1' on drawing). The fold rests against the side of the door. This insert has the legends MUTE BUZZER through RESET inclusive. Ensure correct orientation.
 - b. IDR-2A used with other panels. The procedure is as given for 1a above, but use legends with part number 345-420.
 - c. IDR-6A. The procedure is as given for 1a above, but use legends with part number 345-422.
- 2 Fold the LH LEDS IDR legends (345-418) insert FIRE through POWER at the perforated line. Insert the legends into the bottom right slot (arrow '2' on drawing). The fold rests on the bottom of the slot. Ensure correct orientation.
- 3 Fold the RH LEDS IDR legends (345-419) insert PRE-ALARM through COMMUNICATIONS LOSS at the perforated line. Insert the legends into the bottom left slot (arrow '3' on drawing). The fold rests on the bottom of the slot. Ensure correct orientation.

Note: The IDR repeater is supplied with legends in a number of languages. Part numbers given above are for English language legends.

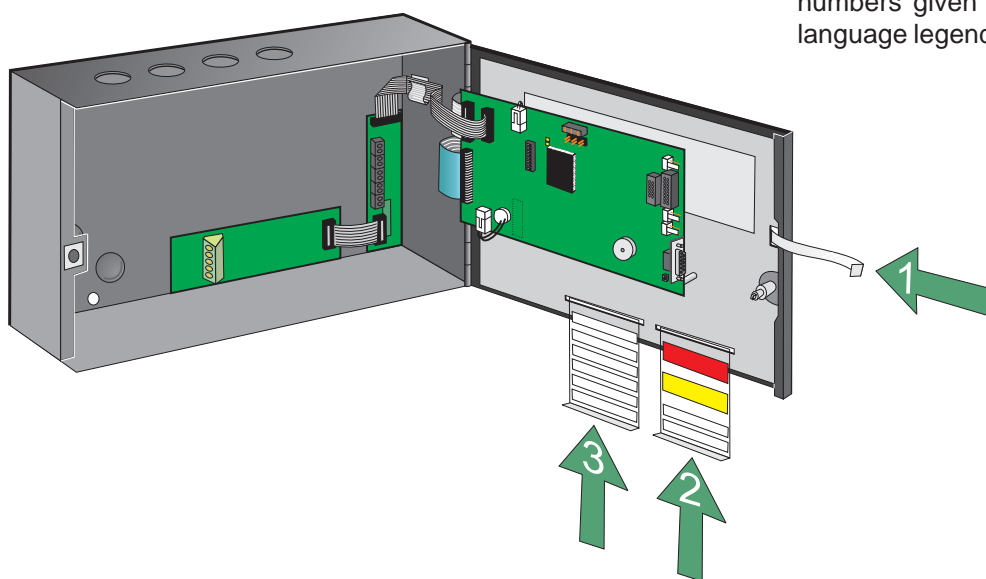



2.6 Isolated RS232 Board (optional)

This board is required only if Notifier-approved equipment is to be connected to the IDR repeater.

To fit the Isolated RS232 Board:

- 1 Use a hex key to open the IDR repeater door (A).
- 2 Orientate the Isolated RS232 Board (B) as shown and secure it to the IDR repeater enclosure (C) using the four M3 X 8 SEM screws (D) supplied with the Board.

Note: The Board is supplied with additional fixings for other applications. These can be discarded.

- 3 Connect the wiring (see drawing opposite).
 - a. Use screened multi-core cable to connect the equipment.
 - b. Use the supplied ribbon cable to connect to the Termination Board.

To remove the Isolated RS232 Board, reverse the procedure for fitting it.

1 & 2

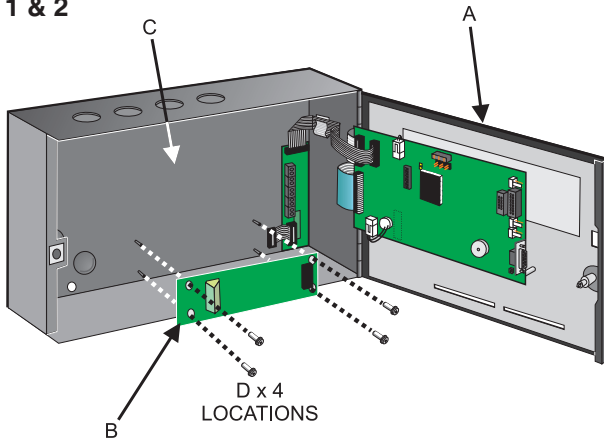

3

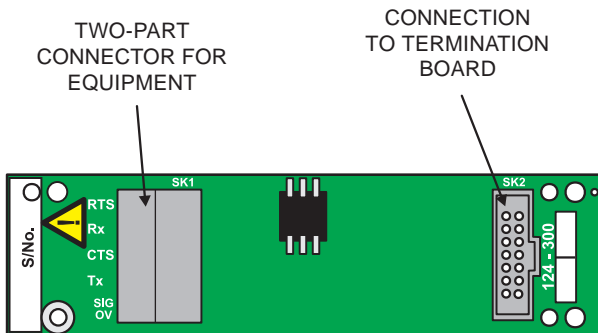

1 & 4

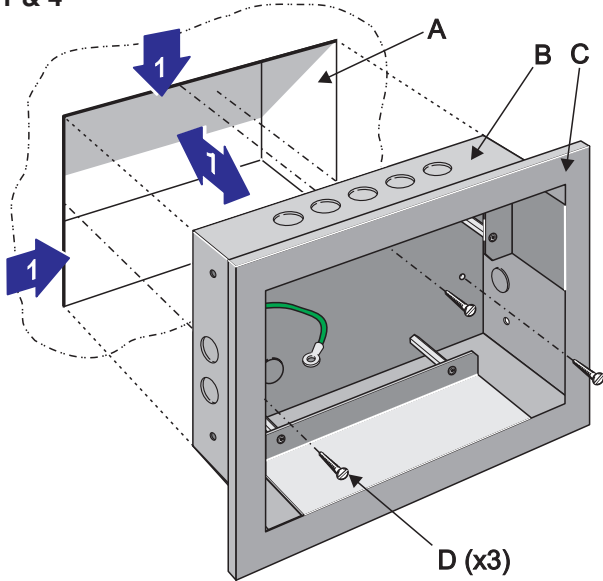

2

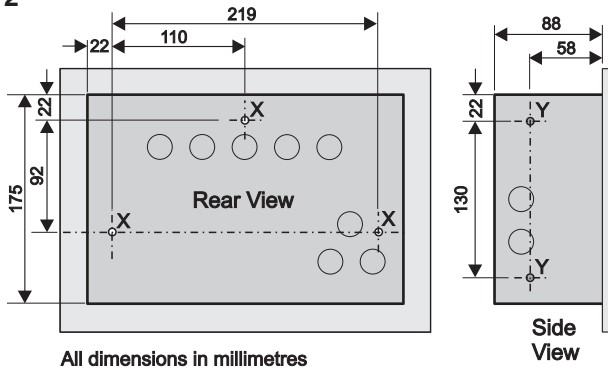

2 & 3

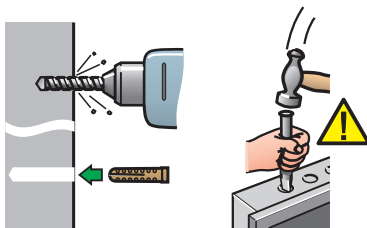

5 & 6

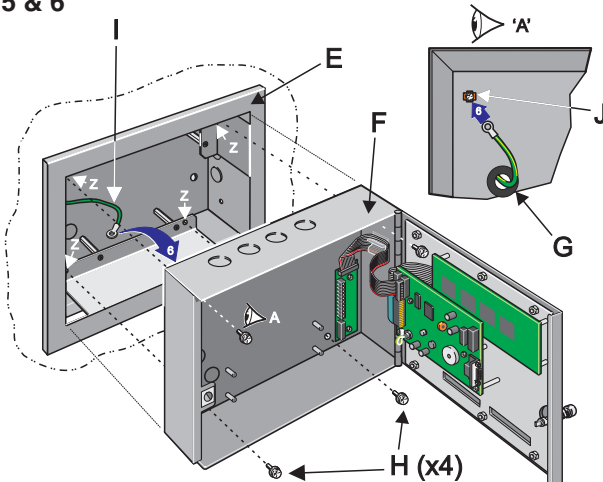

2.7 Bezel Kit (option)

The bezel is supplied with a dedicated back box which has fixing holes, three on the rear wall and two on each side wall. This procedure describes fixing using the rear wall fixing holes, although the procedure can be applied to the side fixing holes. To install the kit:

- 1 At the repeater installation location, make a recess (A) in the vertical surface large enough for the back box (B) to be fully inserted easily and without unnecessary force. The size of the recess must also allow for space required for cable entry into the back box. With the bezel (C) still attached to the back box, offer the assembly to the recess to check for correct depth and clearance. Repeat this process until the correct depth and clearances have been achieved.
- 2 Support the bezel/back box assembly in the desired position in the recess and mark the three screw fixing positions (X) as shown at left. Remove the assembly from the recess. Using an appropriate sized drilling bit, drill and plug three holes to take up to No. 8 (4mm) wood screws. Alternatively, use the side fixing holes (Y).
- 3 Prepare all required knockouts, and fit cable glands as required (see **Section 2.8.1**).

CAUTION: To avoid distortion of the back box when preparing knockouts, place the appropriate back box face on a supporting surface (e.g. work bench).

- 4 Orientate the bezel/back box assembly correctly, offer it to the recess, then feed the cables through the glands and take up any excess slack. Secure the assembly in position using appropriate-sized screws (D) - do not use countersunk-headed screws. To avoid distorting the bezel and/or back box (making it difficult to fit the IDR repeater), do not over-tighten these screws.
- 5 After the bezel/back box assembly (E) has been successfully installed, prepare the IDR repeater (F) for fitting by preparing knockouts, as required, for bringing in all cables for termination. Insert one of the supplied cable grommets (G) into the upper knockout on the rear wall of the IDR repeater. Orientate the IDR repeater correctly, hold the door open and offer the IDR repeater to the installed bezel/back box assembly. Feed all cables through the prepared knockouts and fully insert the IDR repeater into the bezel/back box aperture. Use the four M4 SEM screws (H) supplied in the kit to secure the IDR repeater to the assembly using the four holes (Z).
- 6 Connect the free end of the earth lead (I) to the earth connector (J) provided on the inside of the IDR repeater enclosure (top left corner). Use a suitable-sized, cross-headed screwdriver to tighten at earth point to ensure a good earth connection is made.

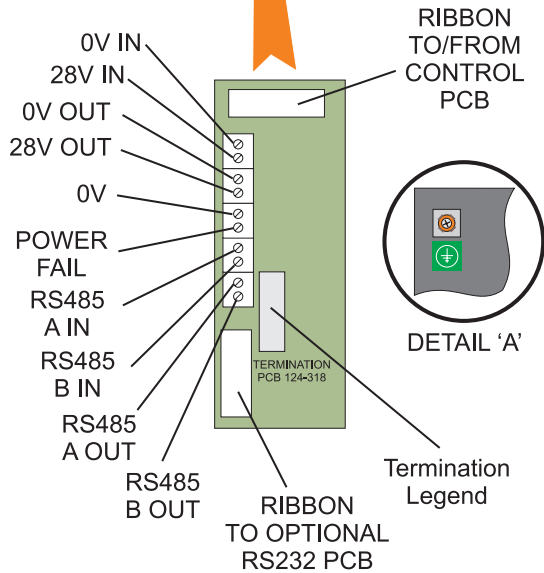
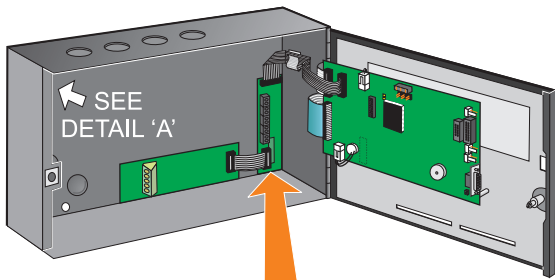

! Only connect power cables when the system power is OFF.

! Only terminate the IDR repeater power cables at the fire control panel after ALL pre-commissioning checks have been done.

! You MUST connect a safety earth wire to the IDR repeater, as described opposite.

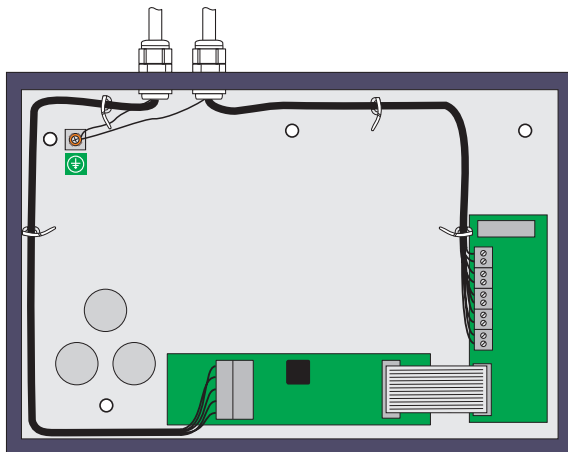

2.8 Installing the Wiring

2.8.1 External Wiring Connections

The following external wiring must be terminated at the Termination Board:

- 28V IN (18-32V dc) and 0V supply, from previous repeater, or from panel, or from external source.

Note: If dc power is derived from the fire control panel, do not exceed the available current (refer to panel specification).

- 28V OUT (18-32V dc) and 0V to next repeater.
- Power Fail (PF) input. Connect to the power supply unit's power fail output or, if there is no such output, link the PF terminal to the 0V terminal immediately above it.

Note: If the PF signal goes high or becomes disconnected, the LCD backlight extinguishes 10 seconds after the failure. It illuminates again if any pushbutton is operated, then extinguishes again after 10 seconds.

- RS485 serial data link (A and B) from the previous station in the network (where 'station' is a fire control panel, repeater or mimic display).
- RS485 serial data link (A and B) to the next station in the network.

Note: Further information about the RS485 serial data link is given in **Section 2.8.2**.

The following external wiring **must** be terminated at the enclosure:

- Safety earth wire. Connect this to the safety earth point, which is clearly marked on the inside top left of the enclosure rear wall - see 'Detail A'.**

Notifier-approved equipment (Network Gateway Unit) may be connected at the optional RS232 board as described in **Section 2.8.3**.

All external wiring **must** be screened and terminated, using any suitable plastic glands, to meet local wiring codes. Terminate screens at the repeater earth point (see detail 'A'). To satisfy EMC requirements, route the wiring along the edges of the enclosure as shown opposite. Use cable ties to secure the wiring at the tie down slots provided.

2.8.2 RS485 Serial Network - Address Switches and Termination Resistors

 Each station address **MUST** be unique. No two stations may have the same address.

 For optimum performance station address numbers should be continuous.

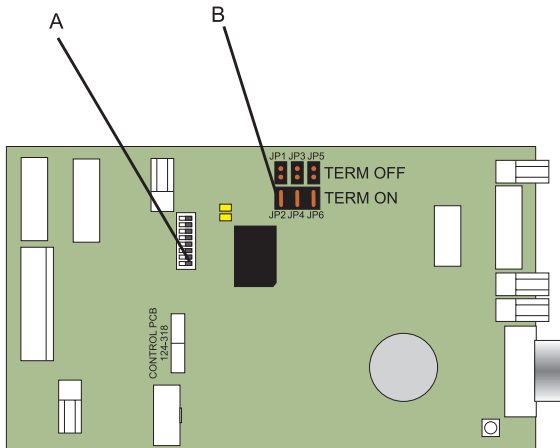

The RS485 network is connected to the Termination Board as shown in **Section 2.8.1**. The following must be set during configuration:

- a. The IDR repeater address; this is set in the range 1 to 31 in binary by using the first 5 switches (A) on the Control Board (address 0 - all switches set to 0 - sets the repeater for 'listen only' and must only be used during commissioning). The decode is given below. Switch 6 must be set to 0 (it is set to 1 in applications which use addresses above 31).

Note: If the IDR repeater is used with an ID50 fire control panel, the address must be set in the range 1 to 16.

- b. Switch 7 must be set according to the type of connection used by the **repeater**, in this case 0 for RS485 (does not have to be the same as in (c) below).
- c. Set switch 8 according to the type of network used by the **fire panel**; set to 0 if an RS485 network (i.e. Master/Slave) is used, or to 1 if an ID²net network is used.
- d. If the IDR repeater is at either end of the RS485 network, TERM ON jumpers JP2/4/6 (B) on the Control Board must be fitted to put the line termination resistors in circuit. If the IDR repeater is not at either end of the network, these jumpers must not be fitted (the link supplied on the Control Board should be placed across TERM OFF jumpers JP1/3/5).

The IDR repeater must be associated with the fire control panel it is to repeat; refer to the fire control panel documentation for the procedure.

Address	Switch settings (1=on)					
	1	2	3	4	5	6
1	1	0	0	0	0	0
2	0	1	0	0	0	0
3	1	1	0	0	0	0
4	0	0	1	0	0	0
5	1	0	1	0	0	0
6	0	1	1	0	0	0
7	1	1	1	0	0	0
8	0	0	0	1	0	0
9	1	0	0	1	0	0
10	0	1	0	1	0	0
11	1	1	0	1	0	0
12	0	0	1	1	0	0
13	1	0	1	1	0	0
14	0	1	1	1	0	0
15	1	1	1	1	0	0
16	0	0	0	0	1	0
17	1	0	0	0	1	0
18	0	1	0	0	1	0
19	1	1	0	0	1	0
20	0	0	1	0	1	0
21	1	0	1	0	1	0
22	0	1	1	0	1	0
23	1	1	1	0	1	0
24	0	0	0	1	1	0
25	1	0	0	1	1	0
26	0	1	0	1	1	0
27	1	1	0	1	1	0
28	0	0	1	1	1	0
29	1	0	1	1	1	0
30	0	1	1	1	1	0
31	1	1	1	1	1	0

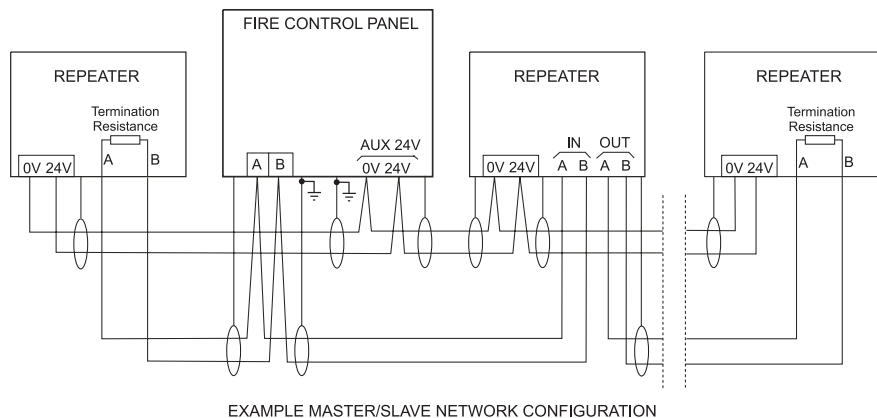

2.8.3 ID²net Network via RS232 - Address Switches

The ID²net is connected by one of two methods as shown in the diagrams below. Connections to the Isolated RS232 Board are shown in **Section 2.6**. DC power connections are shown in **Section 2.8.1**. The following must be set during configuration:

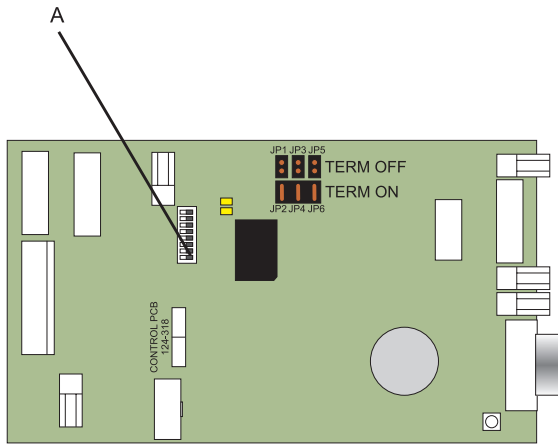

Address	Switch settings (1=on)					
	1	2	3	4	5	6
1	1	0	0	0	0	0
2	0	1	0	0	0	0
3	1	1	0	0	0	0
4	0	0	1	0	0	0
5	1	0	1	0	0	0
6	0	1	1	0	0	0
7	1	1	1	0	0	0
8	0	0	0	1	0	0
9	1	0	0	1	0	0
10	0	1	0	1	0	0
11	1	1	0	1	0	0
12	0	0	1	1	0	0
13	1	0	1	1	0	0
14	0	1	1	1	0	0
15	1	1	1	1	0	0
16	0	0	0	0	1	0
17	1	0	0	0	1	0
18	0	1	0	0	1	0
19	1	1	0	0	1	0
20	0	0	1	0	1	0
21	1	0	1	0	1	0
22	0	1	1	0	1	0
23	1	1	1	0	1	0
24	0	0	0	1	1	0
25	1	0	0	1	1	0
26	0	1	0	1	1	0
27	1	1	0	1	1	0
28	0	0	1	1	1	0
29	1	0	1	1	1	0
30	0	1	1	1	1	0
31	1	1	1	1	1	0
32	0	0	0	0	0	1
33	1	0	0	0	0	1
34	0	1	0	0	0	1
35	1	1	0	0	0	1
36	0	0	1	0	0	1
37	1	0	1	0	0	1
38	0	1	1	0	0	1
39	1	1	1	0	0	1
40	0	0	0	1	0	1
41	1	0	0	1	0	1
42	0	1	0	1	0	1
43	1	1	0	1	0	1
44	0	0	1	1	0	1
45	1	0	1	1	0	1
46	0	1	1	1	0	1
47	1	1	1	1	0	1
48	0	0	0	0	1	1
49	1	0	0	0	1	1
50	0	1	0	0	1	1
51	1	1	0	0	1	1
52	0	0	1	0	1	1
53	1	0	1	0	1	1
54	0	1	1	0	1	1
55	1	1	1	0	1	1
56	0	0	0	1	1	1
57	1	0	0	1	1	1
58	0	1	0	1	1	1
59	1	1	0	1	1	1
60	0	0	1	1	1	1
61	1	0	1	1	1	1
62	0	1	1	1	1	1
63	1	1	1	1	1	1

- The IDR repeater address; this is set in the range 1 to 63 in binary by using the first 6 switches (A) on the Control Board. The decode is given below. Addresses above 63 can only be set by using the Off-line Configuration Tool (in this case the address switches must all be set to 0). Address 0 is not valid for ID²net.
- Switch 7 must be set according to the type of connection used by the **repeater**, in this case 1 for ID²net via an RS232 link.
- Set switch 8 according to the type of network used by the **fire panel**, in this case 1 for an ID²net network.

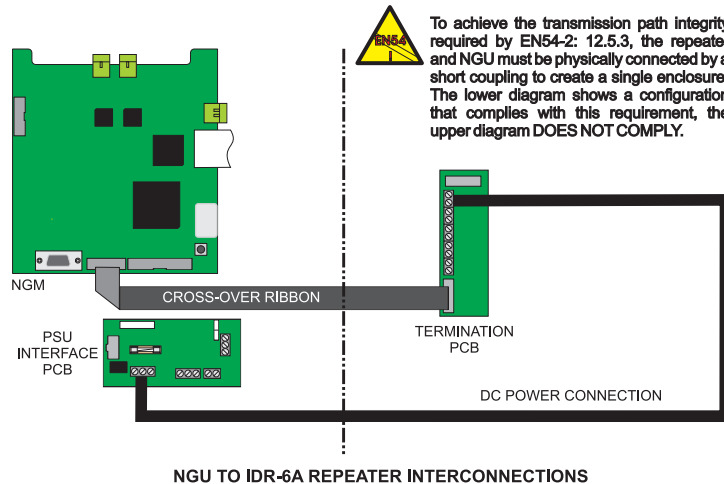
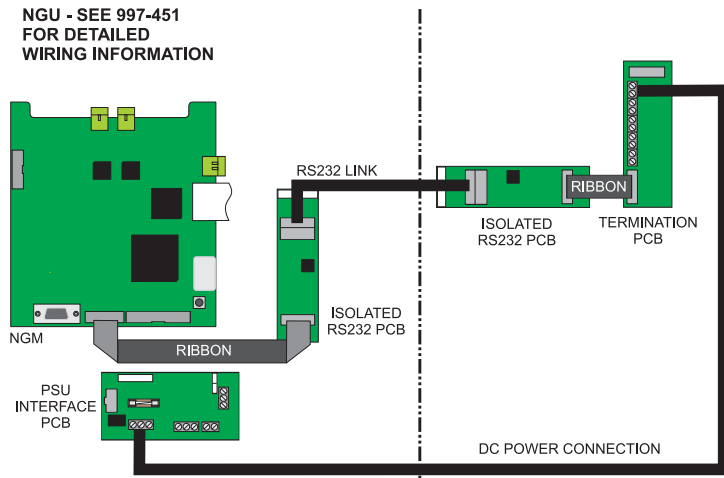

EN54
To achieve the transmission path integrity required by EN54-2: 12.5.3, the repeater and NGU must be physically connected by a short coupling to create a single enclosure. The lower diagram shows a configuration that complies with this requirement, the upper diagram DOES NOT COMPLY.



Only terminate the IDR repeater power cables at the fire control panel after ALL preliminary checks have been done.

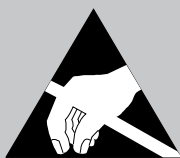

ATTENTION
Observe precautions for handling Electrostatic Sensitive Devices

3 Commissioning

This section gives the procedure for commissioning the IDR repeater.

Commissioning consists of:

- a. Preliminary checks.
- b. Power-up checks.

3.1 Preliminary Checks

Carry out the following preliminary checks for EVERY IDR repeater being commissioned, prior to powering-up the system:

- 1 Check that all cables brought into the IDR repeater have been terminated correctly. The connection of external wiring is described in **Section 2.8.1**. All power and signal cabling and wiring must conform to the appropriate local regulation.
- 2 Check that the address has been set correctly as described in **Section 2.8.2** (RS485 network) or **Section 2.8.3** (ID²net network).

3.2 Powering the Repeater

The IDR repeater obtains 18-32V and 0V dc supplies either from the fire control panel auxiliary outputs or, depending upon the IDR repeater's location, from a local independent power supply. Connections are made as described in **Section 2.8.1**.

It is important to follow the procedure below when powering-up/down the IDR repeaters for maintenance and system upgrades, NOT just when commissioning the IDR repeater.

To power-up the IDR repeater:

- 1 Power-up the fire control panel and power-up any IDR repeaters that use a local independent supply.
- 2 Check that the LCD shows the System Status Normal display (on IDR-6A repeater a list of available languages is displayed first; use the repeater's pushbuttons to select [see **Section 4.5.3.1**]). You may need to adjust the contrast (see **Section 4**).

To power-down the IDR repeater, power down the fire control panel (including battery disconnection), then power down any IDR repeaters that use local independent supplies. The repeater CAN be powered down first, but the panel will then report a fault.

3.3 Passive Repeaters

Additional information for passive repeaters only:

You can access test, language and the edit NORMAL message menu options that normally require access level 2 (i.e. the keyswitch on the active repeater set accordingly) by placing a link (A) across the keyswitch connector on the Control Board. This facility is provided only for use by the installer/commissioner. Remember to remove the link when you have finished!

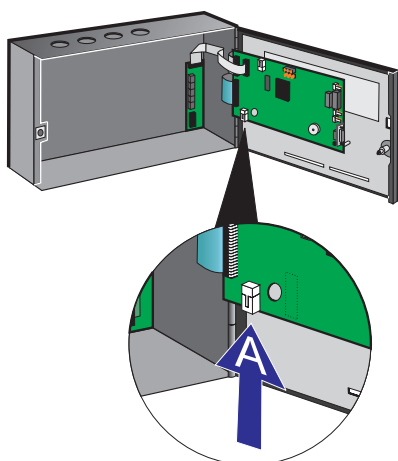

4 Operation

4.1 Controls and Indicators

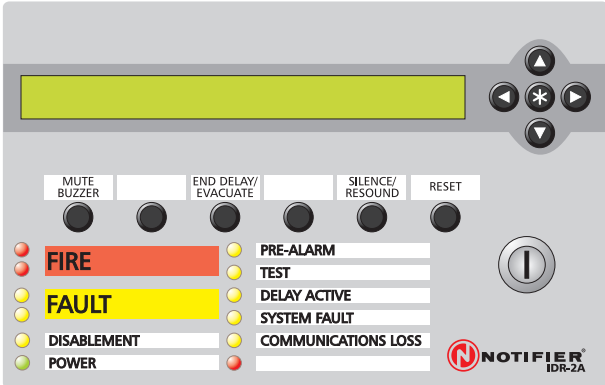

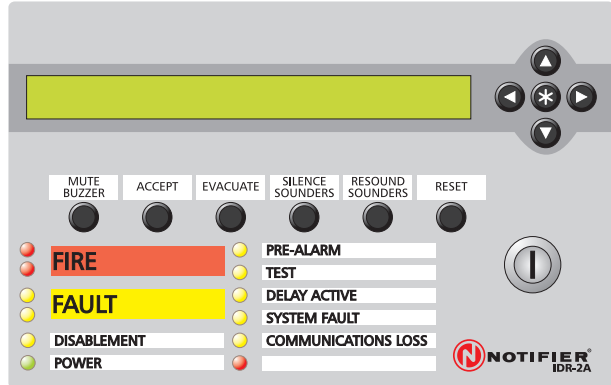

IDR-2A repeater (2 x 40 display) installed for use with ID50 fire control panel
IDR-2P is similar but without the following pushbuttons or the keyswitch





IDR-2A repeater installed for other applications.
IDR-2P is similar but without the following pushbuttons or the keyswitch

PUSHBUTTONS (IDR-2A - ID50 APPLICATION)

- 

MUTE BUZZER Silences repeater and panel buzzers (locally and across the network).
- 

END DELAY/ EVACUATE Sounds all sounders configured for Evacuate. Any active delays are cancelled.
- 

SILENCE/ RESOUND Stops and restarts the sounders.
- 

RESET Restores normal operating status when all alarm conditions have been removed.

PUSHBUTTONS (IDR-2A - OTHER APPLICATIONS)

- 

MUTE BUZZER Silences repeater and panel buzzers (locally and across the network).
- 

ACCEPT Accepts an alarm and silences the IDR repeater's internal buzzer.
- 

EVACUATE Sounds all sounders configured for Evacuate.
- 

SILENCE SOUNDERS Stops the sounders.
- 

RESOUND SOUNDERS Restarts the sounders.
- 

RESET Restores normal operating status when all alarm conditions have been removed.

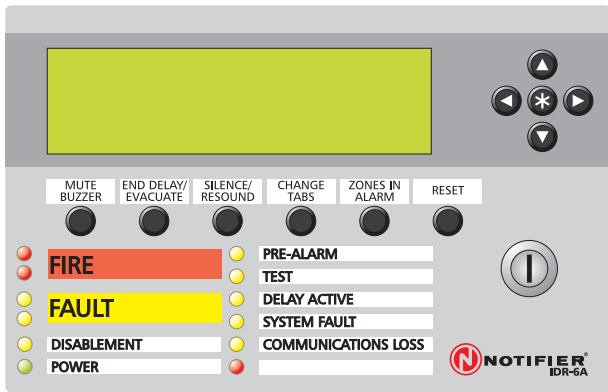

IDR-6A repeater (graphics display)

LCD CONTRAST ADJUSTMENT

Set keyswitch to right, press and hold then press RESET momentarily. The LCD contrast cycles. Press when the contrast is satisfactory, then use and to fine-tune. Press when finished.

Contrast can also be adjusted during Lamp Test (see **Section 4.5.1**).

PUSHBUTTONS (IDR-6A)

- MUTE BUZZER** Silences repeater and panel buzzers (locally and across the network), and accepts an alarm.
- END DELAY/ EVACUATE** If any delays are active, first operation ends the delays, second operation sounds all sounders configured for Evacuate. If no delays are active, first operation performs Evacuate.
- SILENCE/ RESOUND** Stops and restarts the sounders.
- CHANGE TABS** Steps through the tabbed displays.
- ZONES IN ALARM** Displays fire alarm information. If there are fire alarms in more than one zone, steps through these zones.
- RESET** Restores normal operating status when all alarm conditions have been removed.

2A

*** Turn keyswitch for access ***

OR (ID50 REPEATER ONLY)

ACCESS TO MENUS RESTRICTED
Turn keyswitch

6A

User Menu:
Turn Keyswitch for access

TURN KEYSWITCH WHEN THE DISPLAY IS AS SHOWN ABOVE



KEYSWITCH (IDR-2A, -6A)

Setting the keyswitch to the right selects access level 2. Setting it to the centre de-selects access level 2. The procedures given in **Sections 4.3 onwards** require access level 2, unless stated otherwise.

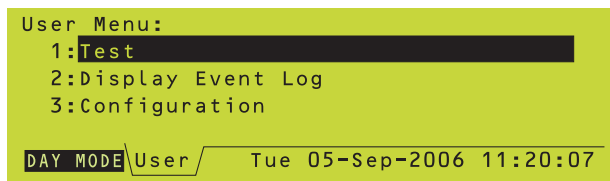
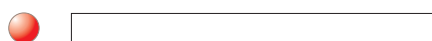
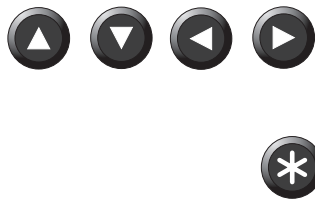

KEYPAD PUSHBUTTONS (IDR-2P, -2A, -6A)

Used to move around the LCD menus. On ID50 repeaters only, is the Cancel pushbutton.

Used to select repeater-specific menus (-2P, -2A) and to select various menu options, as defined on the menus (-2P, -2A, -6A).

LEDs (IDR-2P, -2A, -6A)

A fire condition exists.

A fault condition exists.

There is a disablement on the system (for ID2000 panels, on the associated panel).

The dc power supply to the IDR repeater is present and the IDR processor is operating.

A pre-alarm condition exists.

There is a test occurring on the system.

There is an active delay on the system.

The fire control panel has a system fault.

A network communications problem has occurred and the IDR repeater information is not reliable.

Spare.

Day Mode Indication (IDR-6A)

When the panel is in Day Mode the LCD confirms this status with **DAY MODE** displayed at the bottom of the LCD and to the left of any displayed tabs.

4.2 Menus - General Information

Press (-2A/-2P) or operate the keyswitch (-6A) to enter the IDR repeater-unique menus system. Access level 2 is required, except with the -2P variant. Use the and pushbuttons to select the desired menu. All these menus incorporate a time-out; if no pushbuttons are operated within the time-out period the IDR repeater reverts to the display prior to the menu being accessed.

4.3 Menus: -2A/-2P (Except ID50)

4.3.1 Lamp Test (-2A)

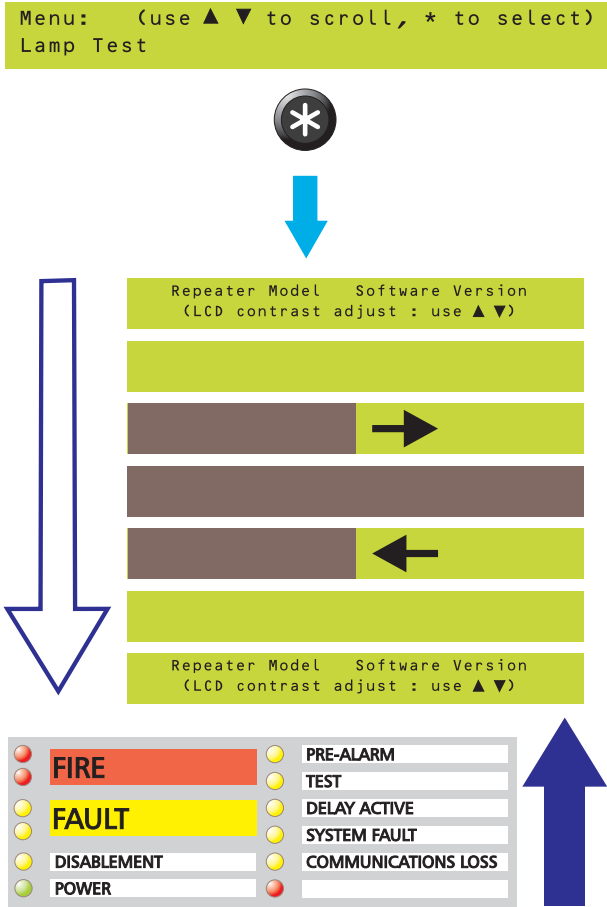

All pixels on the LCD are switched on and then off, the buzzer sounds intermittently, and the LEDs light sequentially in a continuous pattern from bottom right to top left.

To change the contrast of the LCD, press the ▲ or ▼ pushbuttons repeatedly to give the best display, then press * to return to the display prior to test.

If no change is made to the contrast, the test stops automatically and the LCD returns to the display prior to test.

4.3.2 Power Diagnostics (-2A)

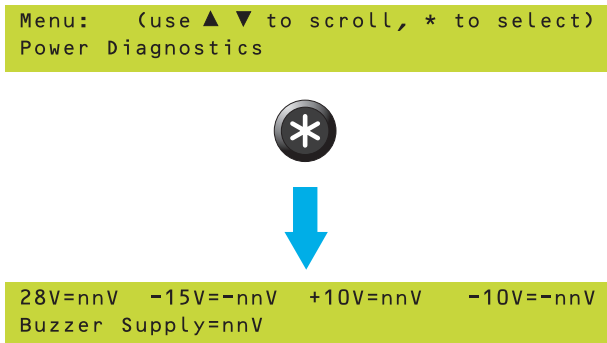

The LCD returns to the repeat display automatically.

The nominal power supplies should be within the following voltage ranges:

Supply	Range
28V	+18V to +32V
-15V	-12V to -17V
+10V	+7V to +12V
-10V	-7V to -12V
Buzzer	+18V to +32V (buzzer off)

4.3.3 Pushbutton Test (-2A)

Menu: (use ▲ ▼ to scroll, * to select)
Pushbutton Test



Pushbutton test (Keyswitch off to exit)
Press button to test



Pushbutton test (Keyswitch off to exit)
UP

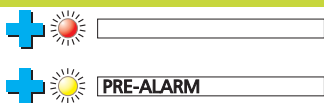

AND AS FOLLOWS:

PUSHBUTTON	ILLUMINATES LED
	TEST
	DELAY ACTIVE
	SYSTEM FAULT
	COMMUNICATIONS LOSS
MUTE BUZZER	Upper General FIRE
ACCEPT	Lower General FIRE
EVACUATE	Upper General FAULT
SILENCE SOUNDERS	Lower General FAULT
RESOUND SOUNDERS	DISABLEMENT
RESET	POWER

Press each pushbutton in turn. Verify that:

- a. The buzzer beeps.
- b. The LCD displays the name of the pushbutton.
- c. The corresponding LED as shown at the left illuminates.

Turn the keyswitch to access level 1 to exit the test.

Menu: (use ▲ ▼ to scroll, * to select)
Edit NORMAL message



▲▼=edit/* to end
NOTIFIER ID2000-----FIRE ALARM SYSTEM



▲▼=edit/* to end
MY NEW NORMAL MESSAGE



Status: NORMAL Mon 22-Jan-01 10:41:56
MY NEW NORMAL MESSAGE

Menu: (use ▲ ▼ to scroll, * to select)
Restore NORMAL message



DEFAULT NORMAL MESSAGE IS USED

Menu: (use ▲ ▼ to scroll, * to select)
Language



Language Menu:
English



REPEATER DISPLAYS ARE IN SELECTED
LANGUAGE

4.3.4 Edit NORMAL Message (-2A)

This option lets you change the message that is displayed on the lower line of the LCD when the system status is normal.

- 1 Use the and pushbuttons to select the character to be edited - it blinks. Use the and pushbuttons to scroll through the available character set until the required replacement character is displayed. Select the next character to be edited, and so on.
- 2 When all edits are complete, press to exit from the message editor.

Note: To exit from the message editor without saving changes, do not press . Instead, turn the keyswitch to return to access level 1.

4.3.5 Restore NORMAL Message (-2A)

To use the repeater's default message instead of the message edited at the repeater, select this menu option and press .

4.3.6 Language (-2A)

Use the and pushbuttons to scroll through the available languages. Press to select the language currently-displayed.

Menu: (use ▲ ▼ to scroll, * to select)
Mute Buzzer



INTERNAL BUZZER IS SILENCED

4.3.7 Mute Buzzer (-2P)

This silences the -2P IDR repeater's internal buzzer. The LCD returns to the display prior to selection of Mute Buzzer.

Menu: (use ▲ ▼ to scroll, * to select)
Cancel



RETURN TO REPEAT DISPLAY

4.3.8 Cancel (-2A/-2P)

This option exits from the repeater-specific menus.

Note: This option is available for the -2P at access level 1; the -2A requires access level 2.

4.4 Menus: -2A/-2P (ID50 Only)

4.4.1 Mute Buzzer (-2P)

This silences the -2P IDR repeater's internal buzzer. The LCD returns to the display prior to selection of Mute Buzzer.

Menu: (use ▲ ▼ to scroll, * to select)
Mute Buzzer



INTERNAL BUZZER IS SILENCED

Menu: (Use ▲ ▼ to scroll, * to select)
LEDs/LCD/Buzzer Test

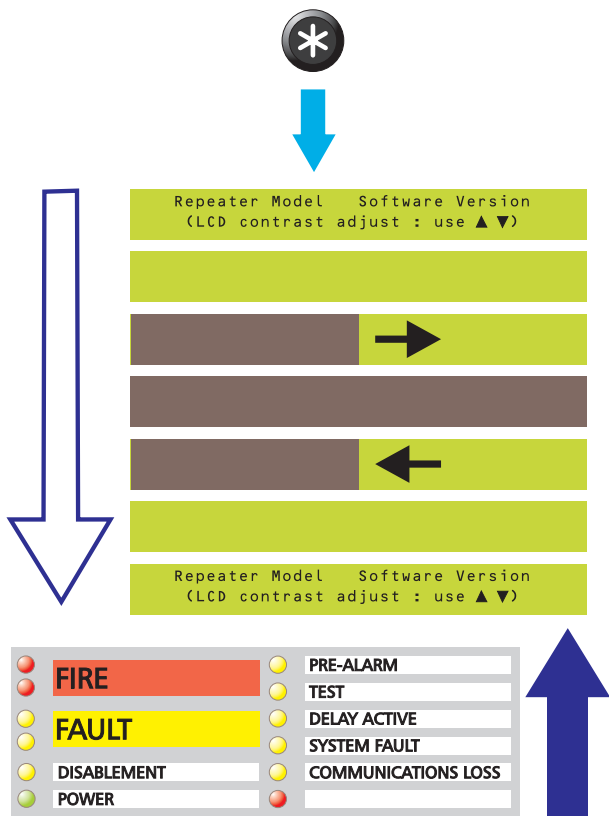

4.4.2 LEDs/LCD/Buzzer Test (ID50 -2A/-2P)

Note: This test is available for the -2P at access level 1; the -2A requires access level 2.

All pixels on the LCD are switched on and then off, the buzzer sounds intermittently, and the LEDs light sequentially in a continuous pattern from bottom right to top left.

At access level 2 only: To change the contrast of the LCD, press the ▲ or ▼ pushbuttons repeatedly to give the best display, then press * to return to the display prior to test.

If no change is made to the contrast, the test stops automatically and the LCD returns to the display prior to test.

Menu: (Use ▲ ▼ to scroll, * to select)
Pushbutton Test

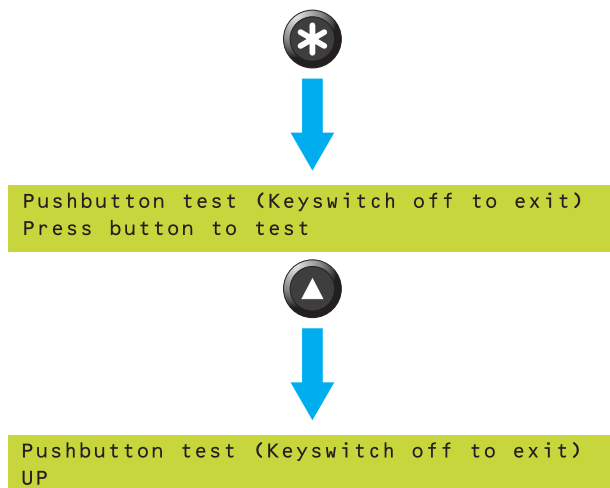

4.4.3 Pushbutton Test (ID50 -2A)

Press each pushbutton in turn. Verify that:

- The buzzer beeps.
- The LCD displays the name of the pushbutton (does not for pushbuttons that are not used).

Turn the keyswitch to access level 1 to exit the test.

Menu: (Use ▲ ▼ to scroll, * to select)
Log

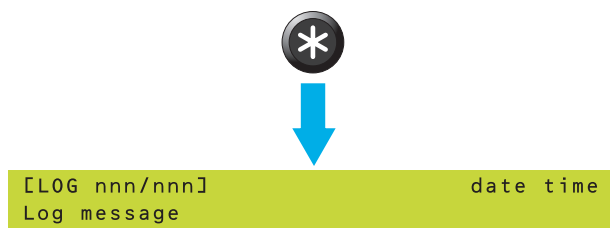

4.4.4 Log (ID50 -2A/-2P)

Use the ▲ and ▼ arrows to scroll through the log messages. Press * to return to the System Normal display.

Note: This option is available for the -2P at access level 1; the -2A requires access level 2.

Menu: (Use ▲ ▼ to scroll, * to select)
Edit NORMAL message



▲▼=edit/* to end
All Systems are Normal



▲▼=edit/* to end
My new Normal message



My new Normal message
date time

Menu: (Use ▲ ▼ to scroll, * to select)
Language



Language Menu:
English



REPEATER DISPLAYS ARE IN SELECTED
LANGUAGE

Menu: (Use ▲ ▼ to scroll, * to select)
Cancel



RETURN TO REPEAT DISPLAY

4.4.5 Edit NORMAL Message (ID50 -2A)

This option lets you change the message that is displayed on the top line of the LCD when all systems are normal.

- 1 Use the and pushbuttons to select the character to be edited - it blinks. Use the and pushbuttons to scroll through the available character set until the required replacement character is displayed. Select the next character to be edited, and so on.
- 2 When all edits are complete, press to exit from the message editor.

Note: To exit from the message editor without saving changes, do not press . Instead, turn the keyswitch to return to access level 1.

4.4.6 Language (ID50 -2A)

Use the and pushbuttons to scroll through the available languages. Press to select the language currently-displayed.

4.4.7 Cancel (ID50 -2A/-2P)

This option exits from the repeater-specific menus.

Note: This option is available for the -2P at access level 1; the -2A requires access level 2.

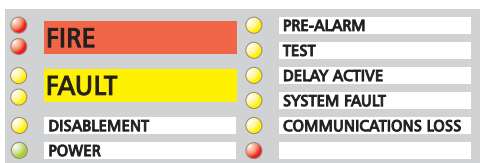
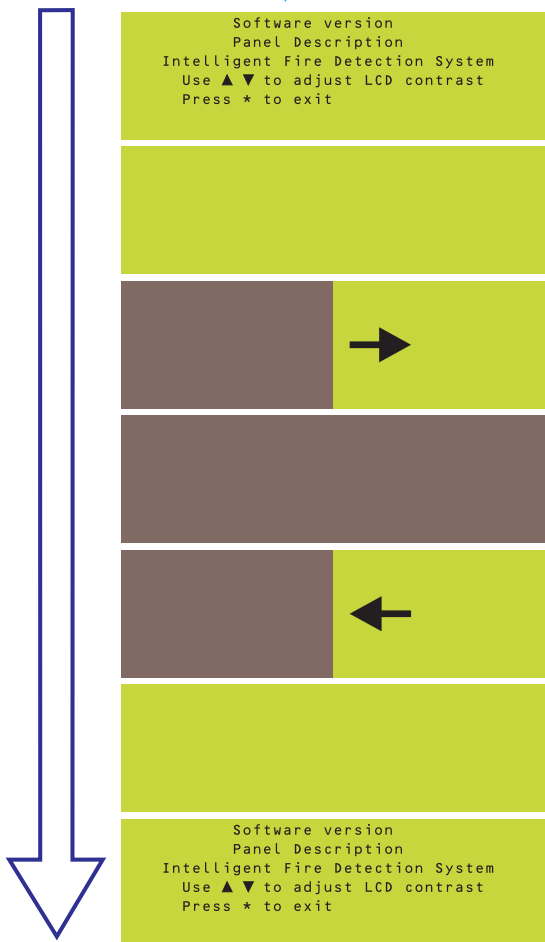
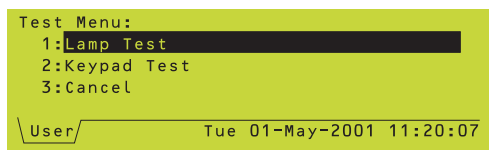
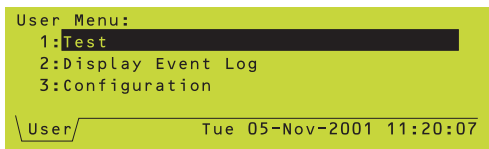

4.5 Menus: -6A

Use the pushbutton to select the required menu option.

4.5.1 Test (-6A)

4.5.1.1 Lamp Test

All pixels on the LCD are switched on and then off, the buzzer sounds intermittently, and the LEDs light sequentially in a continuous pattern from bottom right to top left.

To change the contrast of the LCD, press the or pushbuttons repeatedly to give the best display, then press to return to the User Menu.

If no change is made to the contrast, the test stops automatically and the LCD returns to the User Menu.

4.5.1.2 Keypad Test

```
User Menu:
 1:Test
 2:Display Event Log
 3:Configuration

User Tue 05-Nov-2001 11:20:07
```



```
Test Menu:
 1:Lamp Test
 2:Keypad Test
 3:Cancel

User Tue 01-May-2001 11:20:07
```



```
Keypad test: Turn keyswitch off to exit
```

Press each repeater pushbutton in turn and verify that the corresponding square on the LCD becomes momentarily solid black. The example shows the test display when CHANGE TABS is operated.

Turn the keyswitch counter-clockwise to exit the test and return to the display prior to test.

4.5.1.3 Cancel

This menu option exits from the Test Menu and re-displays the User Menu.

```
Test Menu:
 1:Lamp Test
 2:Keypad Test
 3:Cancel

User Tue 01-May-2001 11:20:07
```



```
User Menu:
 1:Test
 2:Display Event Log
 3:Configuration

User Tue 05-Nov-2001 11:20:07
```

4.5.2 Display Event Log (-6A)

```
User Menu:
 1:Test
 2:Display Event Log
 3:Configuration
User/ Tue 05-Nov-2001 11:20:07
```



```
nnnnn: 28-Apr 08:29
REPEATER CPU RESET
Repeater 5
User/ Tue 01-May-2001 11:20:07
```

Use the ▲ and ▼ pushbuttons to scroll through the logged events by event number.

Press the * pushbutton to exit the log. The repeater returns to the display shown prior to entering the log.

4.5.3 Configuration (-6A)

```
User Menu:
 1:Test
 2:Display Event Log
 3:Configuration
User/ Tue 05-Nov-2001 11:20:07
```



```
Configuration Menu:
 1:Set Language
 2:Set Function
 3:Access Level for MUTE BUZZER
 4:Silence/Resound pushbutton function
User/ Tue 05-Nov-2001 11:20:07
```



```
1:English
 2:Español
 3:Portugues
 4:İslenska
User/ Tue 05-Nov-2001 11:20:07
```

4.5.3.1 Set Language

Use the ▲ and ▼ pushbuttons to select the required language from those available, then press the * pushbutton to return to the User menu.

```

Configuration Menu:
 1:Set Language
 2:Set Function
 3:Access Level for MUTE BUZZER
 ▼ 4:Silence/Resound pushbutton function
 \User/ Tue 05-Nov-2001 11:20:07

```



```

Function Menu:
 1:Standard
 2:VdS
 3:AFNOR
 \User/ Tue 05-Sep-2006 11:20:07

```



```

Select Zone/Device Nomenclature:
 1:PANEL Zones (Loop/Address)
 2:NETWORK Zones (Zone/Reference)
 \User/ Tue 05-Sep-2006 11:20:07

```

```

Configuration Menu:
 1:Set Language
 2:Set Function
 3:Access Level for MUTE BUZZER
 ▼ 4:Silence/Resound pushbutton function
 \User/ Tue 05-Nov-2001 11:20:07

```



```

MUTE BUZZER Access Level:
 1:Access Level 1
 2:Access Level 2
 \User/ Tue 05-Nov-2001 11:20:07

```

4.5.3.2 Set Function

This option ensures that the IDR-6A repeats the panel display in the correct manner.

Use the ▲ and ▼ pushbuttons to select the required function (or cancel):

- Standard. Select this if the Panel Settings of the panel being repeated are set to Standard using local zones or using network zones.
- VdS. Select this if the Panel Settings of the panel being repeated are set to VdS using local zones or using network zones.
- AFNOR. This option is for use only with F-NF3000 fire control panels.

Selecting either Standard or VdS you are now prompted to select one of the following options:

- PANEL Zones (Loop/Address). Select this if the Panel Settings of the panel being repeated are set to Standard or VdS using local zones.
- NETWORK Zones (Loop/Address). Select this if the Panel Settings of the panel being repeated are set to Standard or VdS using network zones.

If the function has been changed, press the * pushbutton to confirm and return to the User Menu.

4.5.3.3 Access Level for MUTE BUZZER

This option selects the access level at which the MUTE BUZZER pushbutton can be operated (level 2 = keyswitch operation).

Use the ▲ and ▼ pushbuttons to select the required level, then press the * pushbutton to return to the User menu.

4.5.3.4 Silence/Resound Pushbutton Function

```
Configuration Menu:
 1:Set Language
 2:Set Function
 3:Access Level for MUTE BUZZER
▼ 4:Silence/Resound pushbutton function
User/ Tue 05-Nov-2001 11:20:07
```



```
Silence/Resound pushbutton function:
 1:Silence/Resound sounders
 2:Disable/Re-enable sounders
User/ Tue 05-Nov-2001 11:20:07
```

By default, option 1 is selected. Option 2 is only available if VdS (local or network zones) is selected at the 'Set Function' menu.

Option 2 is only provided for compatibility with older German systems for which the panel (and repeaters) have this pushbutton labelled 'Akustik AB/AN'. If the pushbutton is labelled 'Akustik AN-/Anstellen' **then option 1 must be selected.**

Use the ▲ and ▼ pushbuttons to select the required level, then press the * pushbutton to return to the User menu.

4.5.3.5 Event Options

```
Configuration Menu:
▲ 2:Set Function
 3:Access Level for MUTE BUZZER
 4:Silence/Resound pushbutton function
▼ 5:Event Options
User/ Tue 27-Jul-2004 11:20:07
```



```
Event Options:
 1:Display all events
 2:Display ALARMS ONLY
User/ Tue 27-Jul-2004 11:20:07
```

By default, option 1 is selected and all events are repeated. If option 2 is selected, only Fire Alarm events are repeated.

Use the ▲ and ▼ pushbuttons to select the required option, then press the * pushbutton to return to the User menu.

4.5.3.6 Technical Alarm LED

```
Configuration Menu:
▲ 3:Access Level for MUTE BUZZER
 4:Silence/Resound pushbutton function
 5:Event Options
▼ 6:Technical Alarm LED
User/ Tue 27-Jul-2004 11:20:07
```



```
Technical Alarm LED:
 1:NO
 2:YES
User/ Tue 27-Jul-2004 11:20:07
```

By default, option 1 is selected. If option 2 is chosen, the PRE-ALARM LED is used to indicate TECHNICAL ALARM instead.

Use the ▲ and ▼ pushbuttons to select the required option, then press the * pushbutton to return to the User menu.

Common DISABLEMENT indication when DELAYS ACTIVE
 1: LIT
 2: NOT LIT
 User Tue 04-March-2008 11:20:07

EN54-2: 9.2
 Delays are a disablement and require the general disablement indicator.



4.5.3.7 Disablement LED

The panel has a general Disablement LED which is configured, by default, to illuminate with the DELAY ACTIVE LED when a delay is active.

The repeater's general Disablement LED can be configured to not illuminate during active delays. Access this option through the configuration menu.

This is not EN54-2 compliant.

4.5.3.8 Network

This option provides a view of the panels and repeaters on a Master/Slave or ID²net Network. Use the ▲ and ▼ pushbuttons to examine the nodes not currently displayed.

A tick symbol is displayed in the 'This' column against the node assigned to this repeater.

No.	Type	This	Sector	Location
▲ 3	Panel		1x	Main Buil..
4	Panel		2x	Workshop 1
5	Panel		2x	Workshop 2
▼ 6	Repeater	✓	3	Side Entr..



No.	Type	This	Sector	Location
▲ 3	Panel		1x	Main Buil..
4	Panel		2x	Workshop 1
5	Panel		2x	Workshop 2
▼ 6	Repeater	✓	3	Side Entrance

Station text is displayed in the 'Location' column. This will be displayed when an event such as an alarm or fault is indicated. Some station descriptions may be too long to be shown fully in the 'Location' column. In these cases only the first part of the description is displayed. To reveal all of the station text, select the node address (node 6 is selected in the example given here) and press the ▶ pushbutton. The complete station text is then revealed.

Network Filtering

Entries in the 'Sector' column indicate the existence of network filtering. These will only be relevant in a repeater connected via an NGU and configured using the Windows Configuration Tool v.2.14, or later.

A repeater will only display alarm, pre-alarm and fault information related to its own sector. All panel and repeater nodes assigned to other sectors will be marked with an 'x' symbol (to the right of the sector reference number) indicating that they are not accessible to this node.

Appendix 1 - Specification

Mechanical

Construction:	Mild steel sheet enclosure. All displays and controls are carried on the enclosure door.
Dimensions (mm):	165.0(h) x 253.5(w) x 50.0(d)
Weight:	1.7kg approx.
Fixing:	Three mounting holes in enclosure
Cable Entry:	4 x 20mm knockouts in top of enclosure 3 x 20mm knockouts in back of enclosure
Terminals:	External connections made using screw terminals capable of accepting cable sizes between 0.5mm ² and 2.5mm ²

Environmental:

Climatic classification:	3K5, (IEC 721-2-3)
Operating temperature:	-5°C to +45°C, (recommended +5°C to 35°C)
Humidity:	5% to 95% R.H.
Height above sea level:	Maximum, 2000m
Panel sealing:	IP 30, (EN 60529)
Vibration:	EN 60068-2-6, 10-150Hz at 0.981ms ⁻² (Meets the requirements of EN 54-2/4)
EMC:	Emissions: EN 50081-1 Immunity: EN 50130-4
Safety:	EN 60950

Electrical

Operating Voltage:	18-32V
Quiescent Current:	90mA
Alarm Current:	120mA (-2A/-2P), 155mA (-6A)
Maximum Fault Current:	Resettable thermal fuse. Nominal - 250mA; absolute max. 600mA
Comms. Medium:	RS485 2-wire serial link or RS232 link
Address Range:	Switch-selectable in range 0-63 (maximum address depends upon the type of fire panel, and the type of network used. Master/Slave: address 0 is unmonitored and must not be used except during power-up commissioning check. ID ² net: address 0 cannot be used)

RS485 Isolated Serial Port

Isolation:	Functional at 42V
Baud rate:	1200 Baud
Connector:	Screw terminals on Termination Board
Maximum cable length:	3000m (minimum of 1mm ² screened cable recommended)

RS232 Serial Port - Temporary PC connection

Baud rate:	9600 Baud
Connector:	D-type on Control Board
Max cable length:	5m

RS232 Isolated Serial Port (Optional) - Notifier-approved Equipment

Isolation:	Functional at 42V
Baud rate:	9600 Baud
Connector:	Terminal block on RS232 Board
Max cable length:	15m

Display and Indications:

Alphanumeric Display:	IDR-2A & 2P use 2 x 40 character LCD IDR-6A uses 64x240 pixel LCD (arranged to give 6 lines of characters)
LED Indicators:	General FIRE and FAULT, DISABLEMENT, POWER, PRE- ALARM, TEST, DELAY ACTIVE, SYSTEM FAULT, and COMMUNICATIONS LOSS

Controls

Pushbuttons - 2A (ID50): MUTE BUZZER, END DELAY/
EVACUATE, SILENCE/RESOUND,
RESET

Pushbuttons - 2A (other): MUTE BUZZER, ACCEPT, EVACUATE,
SILENCE SOUNDERS, RESOUND
SOUNDERS, RESET

Pushbuttons - 6A: MUTE BUZZER, END DELAY/
EVACUATE, SILENCE/RESOUND,
CHANGE TABS, ZONES IN ALARM,
RESET

Keypad - 2P/2A/6A 

Buzzer

In order of decreasing priority:

Fire:	Continuous pulses
Pre-alarm:	3 pulses every 12 seconds
Fault:	Continuous tone
Fire (accepted):	3 pulses every 12 seconds
Pre-alarm (accepted):	3 pulses every 12 seconds
Fault (accepted)	1 pulse every 2 minutes
Disablement	1 pulse every 2 minutes

Appendix 2 - Battery Calculations

During the quiescent period it is reasonable to assume that the minimum voltage from the battery will be 24V for the vast majority of the time. On this premise the 24V supply figure can be used for all systems during this period.

In alarm the final battery voltage may fall to 19V. Allowing up to 1V for cable and other losses, the worst-case supply voltage for non-boosted systems may be as low as 18V. This results in higher currents in alarm for these systems.

At present, Notifier Panels/PSUs fall into the following groups:

Boosted: ID2000, ID2008, ID/NF3000, NF300

Non-Boosted: ID50, ID1000, PS2, PS2/CMX

A non-boosted panel/PSU will require the following battery capacity to support the IDR Repeater:

$$C = (T \times I_q + I_a) \times 1.25$$

where:

C is the calculated battery capacity in Ampere-Hours

T is the required battery backup time in Hours

I_q is the IDR repeater quiescent current in Amperes

I_a is the IDR repeater alarm current in Amperes

1.25 is a multiplying constant to comply with LPS1014

If connected to the auxiliary output of a boosted panel the efficiency of the panel's booster must be allowed for. Notifier recommend using the Loop and Battery Calculator Tool to calculate the total battery capacity required. An approximation can be obtained by multiplying the currents given below by 1.7.

The currents (excluding Isolated RS232 Board) at the above voltages are:

IDR-2A/-2P	@18V	@24V
Quiescent	90mA	80mA
Alarm	120mA	100mA
IDR-6A	@18V	@24V
Quiescent	90mA	80mA
Alarm	155mA	125mA

If an Isolated RS232 Board is fitted, add 5mA to these values.

When calculating the battery requirements it is recommended that the 18V alarm current and the 24V quiescent current be used.

Appendix 3 - IDR-6A Repeater Limitations

<u>Limitation</u>	<u>Applicability of the limitation</u>		
	Repeater is on RS232, panels are on ID ² net	Repeater is on RS485 to local panel, panels are on ID ² net	Repeater and panels are on Master/Slave
<u>Alarm Outputs Disabling</u>			
If 'Alarm Outputs by Zone' for 'All Zones' is selected at the panel, the sounder circuits are included in the disabling. Because the repeater does not receive information about the sounder circuits, it displays a general message 'SOUNDER CIRCUIT (all) Panel <i>n</i> ', in addition to the zone message.	APPLIES	APPLIES	APPLIES
<u>Disabling - detailed display</u>			
When a zone is disabled, the repeater is unable to display details of the devices disabled within the zone, nor the zone name. The device total will not be correct. This applies both to the local panel and to remote panels.	DOES NOT APPLY	APPLIES	APPLIES
<u>Enabling by device</u>			
If a disabled zone on the panel to which the repeater is connected is re-enabled by enabling every device individually, the zone is then no longer displayed as disabled. However, if the zone is on a remote panel it continues to be displayed as disabled, because the repeater does not receive information about devices on these panels.	DOES NOT APPLY	APPLIES	DOES NOT APPLY, BUT THERE MAY STILL BE ERRORS IN THE DISPLAY
<u>Delay Active</u>			
The repeater has a DELAY ACTIVE LED which illuminates steady when the panel's DELAYS ACTIVE LED is lit. If a delay is in progress, the panel's LED flashes and its LCD shows a timer bar. The repeater does not receive this progress information and its LED remains steady.	APPLIES	APPLIES	APPLIES
<u>Walk Test</u>			
During a walk test, the repeater does not display untested devices, nor the 'Not Tested' total. This applies both to the local panel and to remote panels.	DOES NOT APPLY	APPLIES	APPLIES



 **NOTIFIER**[®]
by Honeywell

Charles Avenue
Burgess Hill
W. Sussex
RH15 9UF

T: +44 (0) 1444 230 300
F: +44 (0) 1444 230 888
E:
sales@notifierfiresystems.co.uk
www.notifierfiresystems.co.uk

local distributor



Every care has been taken in the preparation of this document but no liability can be accepted for the use of the information therein. Design features may be changed or amended without prior notice.

