

# **EDS-2000-AM**

## **Outdoor Dual-Tech Motion Sensor (Single PIR, Microwave And Antimask)**

### **INSTALLATION INSTRUCTIONS & USER MANUAL**

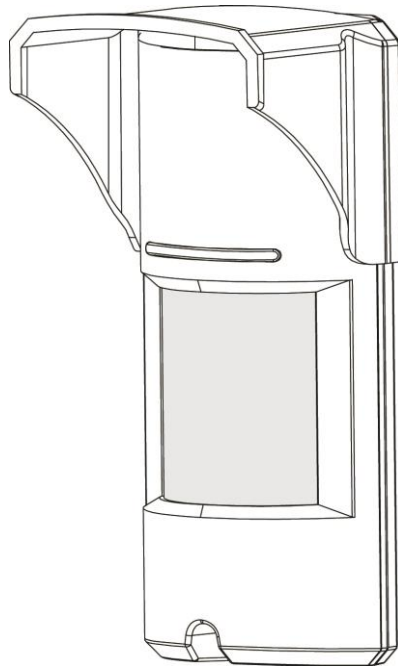

## 1 **General**

The EDS-2000-AM is a unique motion detector utilizing a single (quad element) passive infra-red element and Microwave technology with antimask feature for use outdoors in harsh environments.

The EDS-2000-AM is designed for outdoor use in the most severe and climatic conditions and may also accommodate pets with the addition of optional pet immunity lenses.

High reliability is achieved by combining both dual tech hardware with highly sophisticated software, greatly reducing the possibility of false alarms.

The active elements are comprised of a single (quad element) PIR and advanced Microwave detector inside a stylish, rigid plastic body.

These special optics combined with a Microwave Doppler sensor assures elimination of “false alarms” while maintaining high security standards for the detection of human intruders into the protected area. The detection sensitivity and range is controlled by a potentiometer allowing fine tuning, so that the correct detection pattern will be set for every installation.

The EDS-2000-AM is designed to protect large areas and can easily be installed on walls in order to provide a solid protection of the area while rejecting interferences from birds and small animals with the optional “PET MASK” optics.

## 2 **Features**

- Microwave detection based on Doppler concept.
- Installation height is 1.2m (Grade 3) or 2.1m (Grade 2)
- PIR sensitivity adjustment.
- MW intensity selection.
- Temperature compensation.
- Microcontroller signal processing.
- Anti mask mechanism (for PIR lens).
- Front and back tamper protection.
- Unique waterproof and sealed plastic design.
- Detection Range: Grade 2 - Up to 12m; Grade 3 - Up to 8m.
- Detects human intruders walking or running.
- No maintenance required.
- High RFI/EMI Immunity.
- Protection from: direct sunlight, wind up to 30 m/sec, snow and rain, small animals, removal of top cover and removal from mounting bracket (Tampers).

### 3 Assembly description

The EDS-2000-AM is a robust yet small detector which includes a large LED indicator that can be easily observed from long distances to provide indication of intrusion. Using the supplied mounting bracket, the EDS-2000-AM can be easily mounted to walls using the provided mounting screws. For installations requiring the detection beam to be adjusted horizontally or vertically to obtain the desired field of protection use the Outdoor Mounting Bracket pictured below. (not included)

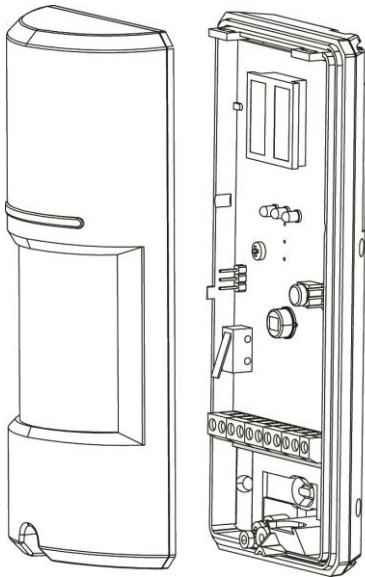

EDS-2000-AM Outdoor Motion Detector

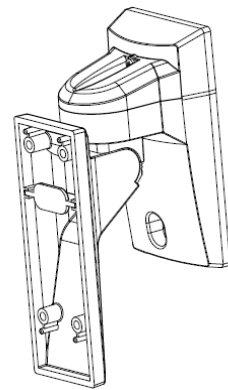

Outdoor Mounting Bracket

(See separate installation instructions

P/N: 7141720 rev. A)

The EDS-2000-AM consists of two detection elements:

- PIR element
- Microwave element

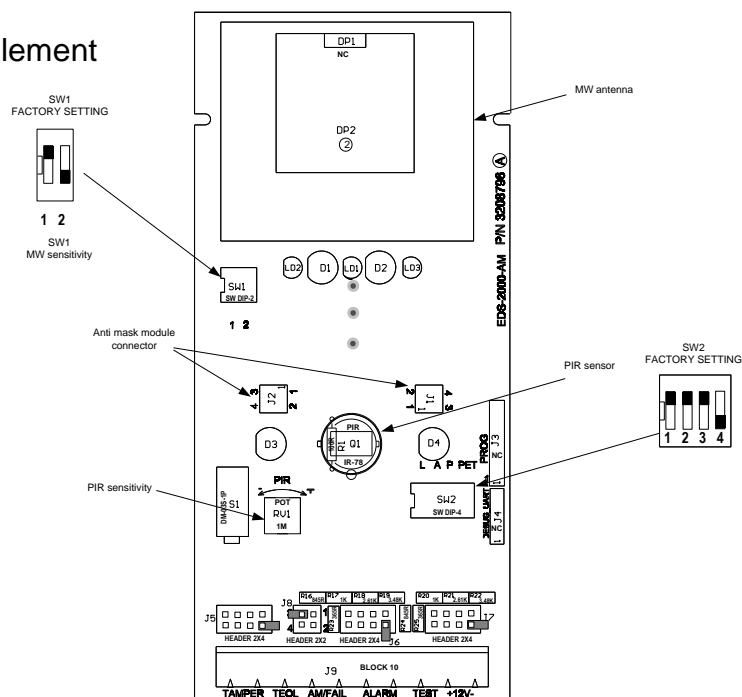

#### 4 Detection Pattern

The EDS-2000-AM has a 90° top view PIR and MW detection pattern with 12m detection distance (when installed at 2.4m above the ground surface).

##### Standard Lens – Grade 2

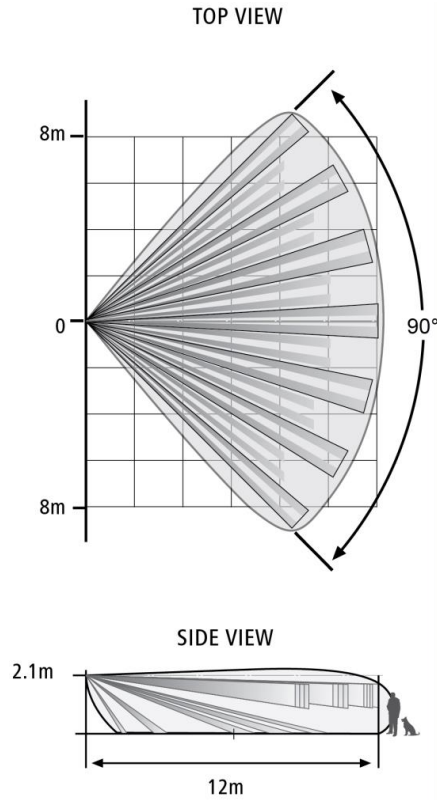

##### Standard Lens – Grade 3

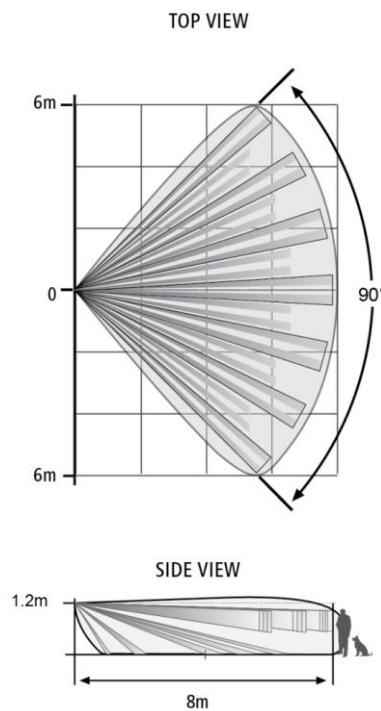

Corridor Lens – Optional (sold separately)

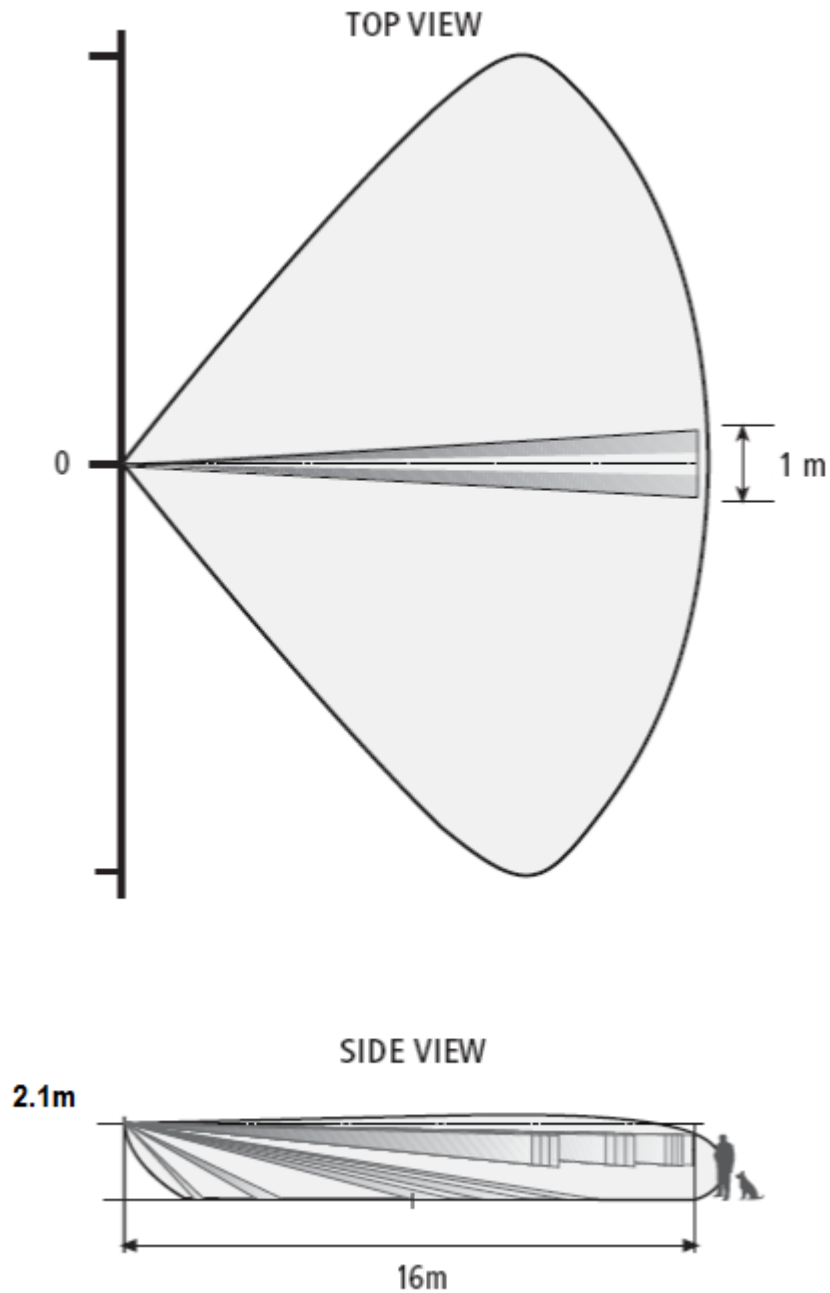

**Note:** This option is not suitable for EN50131-2-4 compliant installation.

Having MW movement detection combined with PIR detection beam, the EDS-2000-AM can differentiate between pets and human bodies and alert accordingly.

By having both PIR detection beam and MW crossing an object it will be defined as intrusion, causing an alarm. In case only MW detects motion and PIR does not, no alarm will be generated.

## 5 Selecting mounting location

The installation of the EDS-2000-AM requires straight and solid base for the detector and setting of front panel against the center of protected area.

The protected area must be free from obstacles like walls, fences, trees, ditches and other microwave detectors, as well as systems of anti-intrusion surveillance.

The bracket provides EDS-2000-AM installation on a wall. The wall should be leveled.

Choose a location most likely to intercept an intruder according to detection pattern on pages 4 & 5.

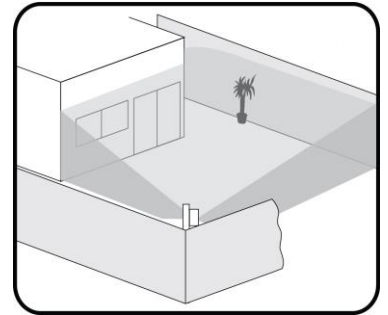

Avoid the following Installation Locations:

- Facing direct sunlight.
- Facing areas subject to rapid temperature changes.
- Mounted at more than 10° from the vertical or horizontal plane.
- Facing metal doors.
- Near direct sources of heat or airflow.
- Clear all physical obstacles from the detection area (e.g. plants, laundry, etc.)
- Clear all light reflecting surfaces from the detection area, including puddles or other standing water.
- Avoid installation on the following types of ground:  
Thick vegetation, Grass (un-mown), Water, Sand and Metal.

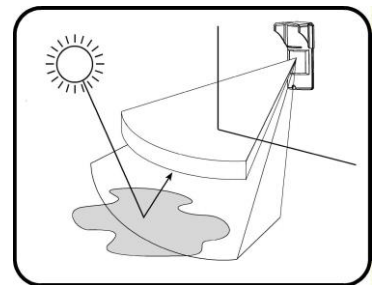
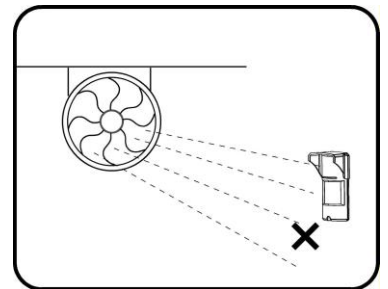

### NOTES:

- Recommended installation height is: Grade 2: 2.1m (6.8 ft); Grade 3: 1.2m (3.9 ft).
- The PIR sensor detects motion crossing the beam; it is less sensitive detecting motion towards the detector.
- The EDS-2000-AM performs best when provided with a constant and stable environment.
- In order to ensure suitable operation of the EDS-2000-AM, the type of ground should be one of the following: Asphalt concrete, Cement, Soil, Clay, Gravel or Grass (mown).

## 6 Detector Installation

**Important!** Prior to installation, read both “Operation” and “Selecting the mounting location” sections carefully.

1. Install the detector in such manner that the intruder is most likely to cross the detection area from side to side.

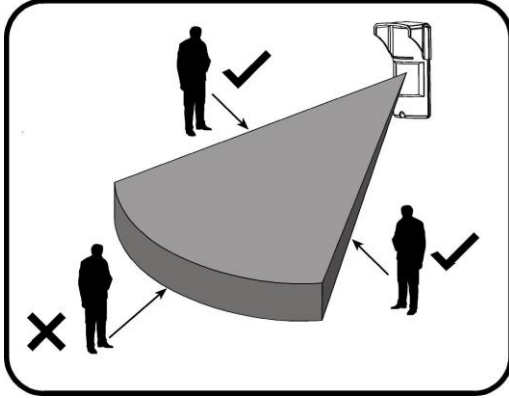

2. The detector is to be installed at height of 2.1m (6.9 ft.) for Grade 2 or 1.2m (3.9 ft.) for Grade 3

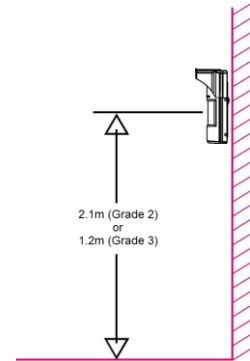

3. Make sure to attach the metal bracket to a leveled straight and firm wall, leaving 10cm (3.9 inches) from the top and 10cm (3.9 inches) from both sides, for easy installation and maintenance.

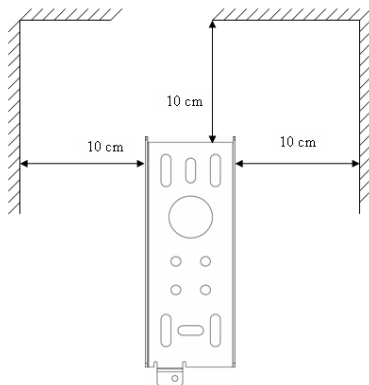

4. Placing the detector on perpendicular wall is required for guarding a side window opening. Alternately the Outdoor Mounting bracket can be installed on the same wall, allowing the detector beam to be rotated towards the window.

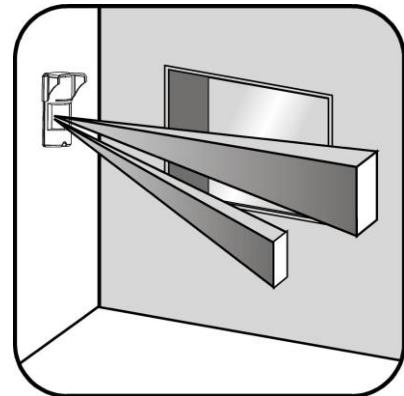

5. Open the detector unwinding the bottom screw.

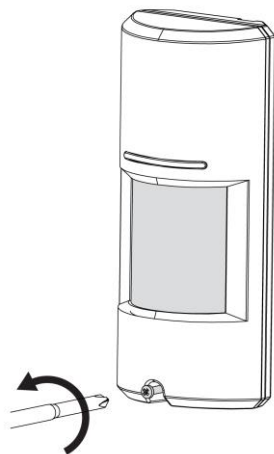

6. Release the rear metal bracket by unwinding internal bottom screw.

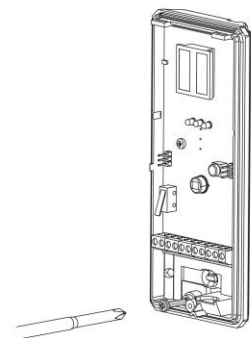

7. Release the detector body from the metal bracket by pulling the detector up and out.

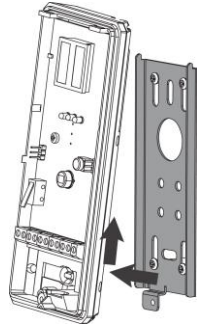

8. Attach the rear bracket to the wall using mounting screws.

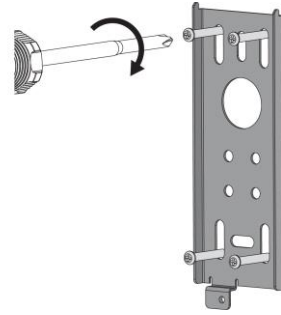

9. Insert wires through provided access hole and wiring channels. Attach the sealing sponge pad to the wire opening from the rear side after the wires have been connected and prior to final product affixing to the mounted bracket.

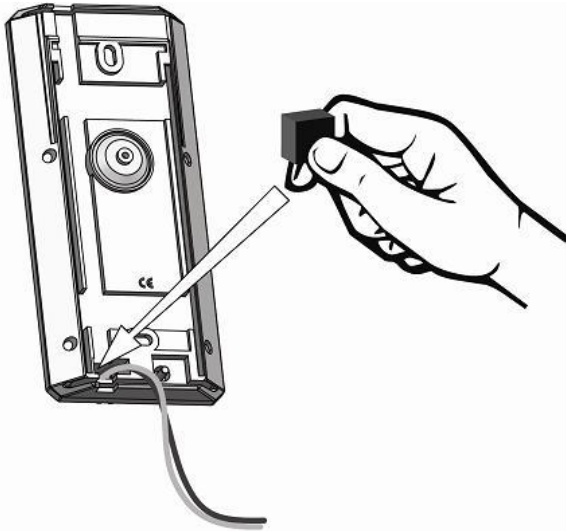

10. Use double side adhesive washer before re-mounting the detector on the back bracket.

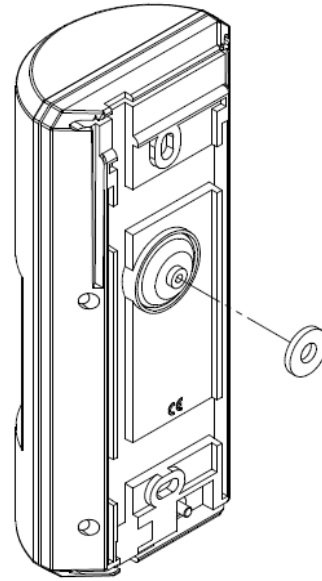

11. Place the detector on the mounting bracket from top side down and then lock the screw at the bottom.

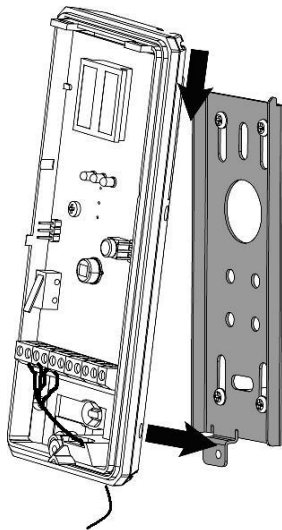

12. If Pet immunity up to 15kg is desired do not install the mechanical pet filter.

If Pet immunity up to 36kg is desired install the mechanical pet filter. In this case, the AM option must be turned off to avoid AM alarm.

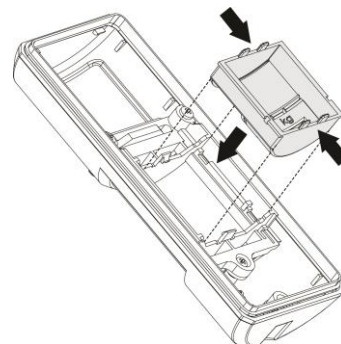



## 7 Terminal Block Connections

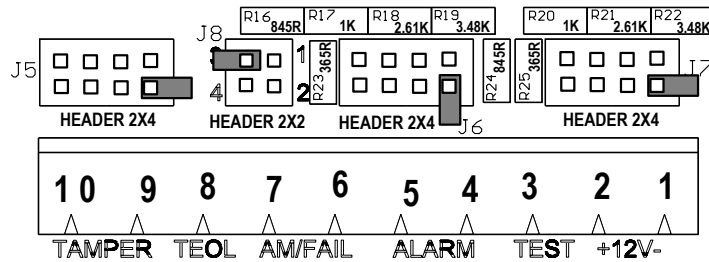

Terminal 1 - Marked "+" (+12V) - Connect to a positive Voltage of 9 -16Vdc source (Usually from the alarm CP)

Terminal 2 - Marked "-" (GND) - Connect to the ground of the CP.

Terminal 3 –Marked "Test" 9-16 v on this pin will enter the EDS-2000-AM to walk test mode even if SW2 position 1 is off

Terminals 4 & 5 - Marked "ALARM" - These are the output relay contacts of the detector. Connect to a normally closed or normally opened zone in the control unit. When an intruder is detected, alarm relay (N.C.) will switch for 1.8 sec.

Terminal 6 & 7 - Marked "AM/FAIL" These are the output of the anti mask and Trouble relay (N.C.). Will switch if one from the following scenario happens:

The supply voltage is under 8.5v

Mask detection (together with ALARM relay)

PIR or MW self test fail (every 10 hours the detector made self test for PIR and MW sensors)

Terminal 8 - Marked "TEOL" - End of line – optional terminal for end of line resistors connections.

Terminals 10 & 9 - Marked "TAMPER" - If a Tamper function is required connect these Terminals to a 24-hour normally closed protective zone in the CP.

If the top cover of the detector is opened or the detector is detached from installation wall, an immediate alarm signal will be sent to the CP. In case optional wall bracket is used, connect the back bracket's wires in series with the control Panel.

*(See separate installation instruction of Outdoor Mounting Bracket)*

### 7.1 Wire Size Requirements

Use #22 AWG or larger wires. Use the following table to determine required wire gauge and length.

Wire Length [m]	205	310	510	870
Wire Length [ft.]	800	1200	2000	3400
Wire Gauge [#]	22	20	18	16

## 8 End Of Line

In case there is a need to use EOL connection method, it is necessary to choose different resistances for different functions/outputs (Tamper/Alarm/Trouble).

End-Of-Line resistors are intergarded on the EDS-2000-AM. These resistances are obtained on the table below:

<b>Jumper group</b>	<b>Jumper No</b>	<b>Resistor value</b>
Tamper	1	845R
	2	1K
	3	2K61
	4	3K48
Alarm	1	845R
	2	1K
	3	2K61
	4	3K48
Trouble (AM/FAIL)	1	845R
	2	1K
	3	2K61
	4	3K48

Note: Check on the control panel's manual which resistances to use.

## 9 Settings & Adjustments

### 9.1 Detection beam direction

The EDS-2000-AM detection beam direction is fixed. As a result, it is recommended to face the intrusion area with the detector.

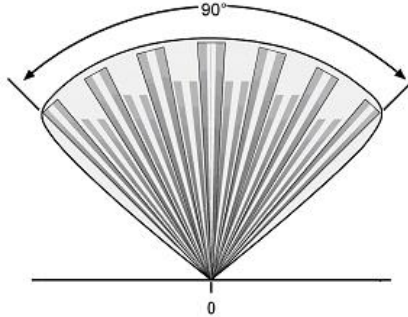

### 9.2 Sensitivity and Range Adjustment

There are 2 options for PIR sensitivity option:

PIR potentiometer adjust

SW 2 position 3 – PIR pulse setting when up- 2 pulses down -3 pulses

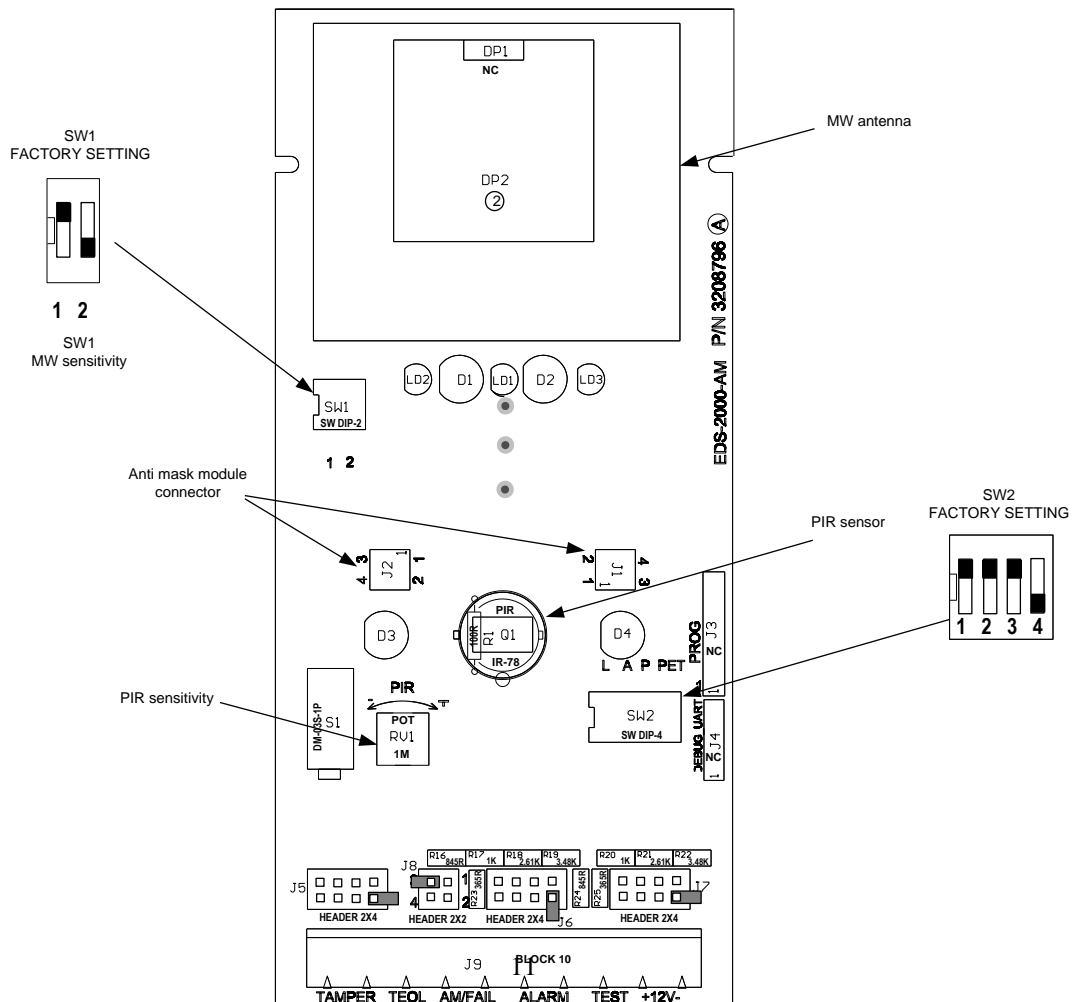



General configuration setting table (for SW2)

Feature	SW position	On (up)	Off (down)
Indication LEDs	1	Indication LEDs on (*)	Indication LEDs off
Anti Mask	2	ON (*)	Off
PIR pulse count	3	2 pulses(*)	3 pulses
Pet immunity	4	On	Off (*)

**Factory setting is marked with (\*) and match the EN50131-2-4 compliance test setups.**

The sensitivity adjustment is performed by setting a potentiometer and MW jumper as follows (using clock needle positioning):

Environment type	Potentiometer position
Maximum sensitivity	4 o'clock 
Middle sensitivity	12 o'clock 
Minimum sensitivity	8 o'clock 

**Note: Adjust sensitivity according to environmental conditions!**

### 8.2.2 MW Sensitivity adjustment

The MW has 4 configurable levels by SW1:

Position 1	Position 2	
UP	UP	(*) High sensitivity more suitable for indoor application
UP	DOWN	High sensitivity for outdoor application
DOWN	UP	Medium sensitivity for outdoor application
DOWN	DOWN	Low sensitivity for outdoor application

Note: Setting both MW switches to UP position sets PIR sensitivity to Pulse 1, disregarding the PIR switch status (SW2, position 3). This way very high sensitivity is achieved.

**Factory setting is marked with (\*) and match the EN50131-2-4 compliance test setups.**

### 8.3 Pet immunity setting

The EDS-2000-AM has a detachable Pet immunity filter. As such the Pet immunity level may vary between:

1. 36kg (80 lbs) with pet immunity filter assembled
2. 15kg (33 lbs) if no pet immunity filter is used.

**Note:** Adding the detachable Pet immunity filter will cause anti mask alarm. In order to use the filter, turn off the anti-masking feature (SW2-position 2: OFF).

This option is not suitable for EN50131-2-4 compliant installation.

You can apply an electric pet immunity by pulling SW2-position 4 to ON position.

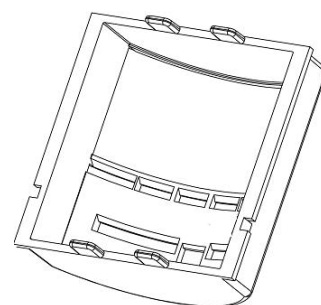

The installer is to select the requested Pet immunity level.

The filter is to be installed according to the following orientation:

This side up!

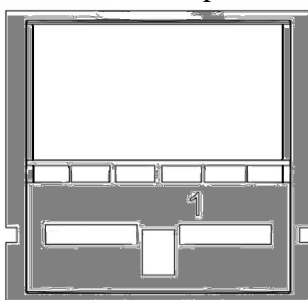

## 8.4 Indications setting

### **The EDS-2000-AM has 3 LEDs that each points at different indication:**

- a. Green LED indicates PIR detection.
- b. Yellow LED indicates MW detection.
- c. Red LED - alarm indication (logic AND of both MW and PIR).
- d. Masking indication: Red LED and Yellow LED blinking
- e. Fault indication: Yellow LED blinking

The installer has an option to control LEDs operation, using the LED control on SW2 position 1, between "ON" and "OFF". Or by apply 9-16v to terminal block position 3 ("test")

- Place the top cover to the base and close it using the bottom screw.

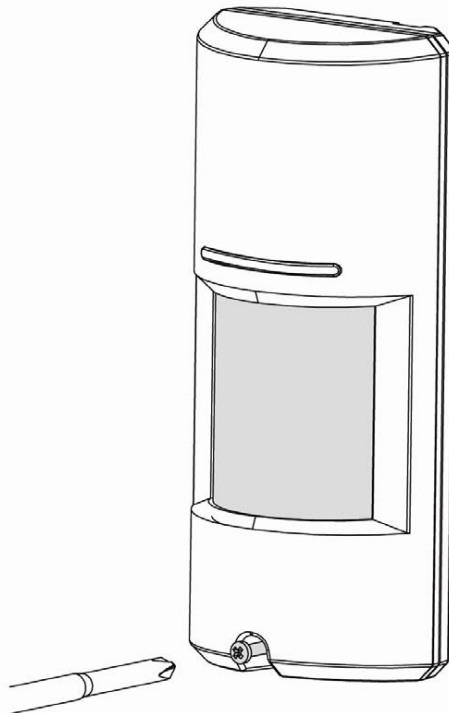

## 9. Anti mask

The EDS-2000-AM has a sophisticated anti mask module:

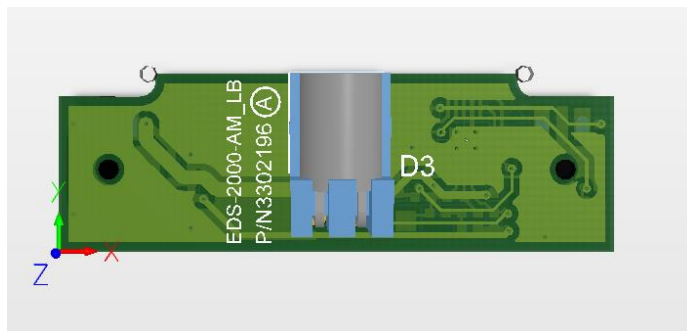

This module is assembled on the EDS-2000-AM main board.

To activate the AM please pull up SW2 position 2 and remove the PET optic filter.

The EDS-2000-AM has an ambient light sensor.

The EDS-2000-AM self calibrates for anti mask 30 minutes after power up.

Please verify during installation that the EDS-2000-AM is closed well before 30 minutes from power up.

In case initial calibration is done while facing direct sunlight, the calibration process will be automatically reinitiated after 30 mins until the direct light intensity is reduced adequately.

Mask indication is obtained once the detector mask functionality is activated. This is achieved once the detector is optically blocked (pained, covered)

In order to restore mask condition, remove the obstacle from the detector and generate basic detection to generate intrusion alarm – this may be achieved by walking or waiving in front of the detector.

## 10. Operation

**Note! Connect the EDS-2000-AM to a positive Voltage output of 9 -16VDC source.**

Use only a listed power limited source.

The detector shall be provided with minimum of 4 hours of standby power from either a listed compatible control unit or power supply.

The detector is automatically operated once connected to power.

The LEDs start flashing one at a time (side to side) for 30 seconds during the warm-up period and after that they will turn off.

At this time the detector is ready for operation.

## 11. Self-test

Self test is meant to ensure that the detector functionalities (PIR & MW) are working properly.

Self-test occurs on initial warm-up and every 10h afterwards.

Following the self-test, if any technical failure is obtained, the yellow LED will flash constantly – this means that the detector is out-of-order.

## 12. Test procedures

### Walk Test

Make sure LEDs control is set to “ON”

Allow 30 seconds of warm up time.

Make sure that the protected area is cleared of all people.

Start walking across the detection zone.

Look at the LEDs whenever motion is detected - all LEDs are turned ON.

Allow 5 sec. between each test for the detector to stabilize.

Upon installation, the unit should be thoroughly tested to verify proper operation.

Walk across the entire area where coverage is desired. Should the coverage be incomplete, readjust sensitivity or relocate the detector.

Once coverage is as desired the LEDs may be disabled.

***NOTE:*** *Walk Test procedure should be conducted, at least once a year, to confirm proper operation and coverage of the detector.*



### 13. Specifications

<b>Detection Method</b>	PIR AND MW
<b>Microwave Frequency</b>	X-band (9.9GHz / 10.525GHz / 10.687GHz)
<b>Power Input</b>	9 to 16Vdc
<b>Current Draw</b>	Standby: 28mA (±5%) Active: 35mA (±5%)
<b>Temp Compensation</b>	Dual slope temperature compensation
<b>Alarm Period</b>	2 sec (±0.5sec)
<b>Alarm Outputs Tamper Switch(s)</b>	Form B only (NC, Common) 28Vdc 0.1 A with 10 Ohm
	Two Switches N.C 28Vdc 0.1 A with 10 Ohm Series protection resistors Opens when cover is removed from unit's base
<b>Warm up Period</b>	30sec (± 5sec)
<b>Operation Temp</b>	-25°C ~ +55°C
<b>Dimensions</b>	160 mm x 70 mm x 45 mm
<b>Weight</b>	210gr.
<b>European directives</b>	EN300440-2, EN301489-3, EN301489-1, EN50130-4, EN61000-6-3, EN60950-1, EN60950-22, EN 50581, IEC/TR 62476, EN50131-1 (Grade 3), EN50131-2-4, EN50130-5 (Class-IV)
<b>USA &amp; Canada</b>	47CFR part 15, subpart C, section 15.245, 47CFR part 15, subpart B, RSS210, ICES-003
<b>Protection Degree</b>	IEC 60529: IP 65

\* Specifications are subject to change without prior notice.

#### CROW ELECTRONIC ENGINEERING LTD. ("Crow") - WARRANTY POLICY CERTIFICATE

This Warranty Certificate is given in favor of the purchaser (hereunder the "**Purchaser**") purchasing the products directly from Crow or from its authorized distributor. Crow warrants these products to be free from defects in materials and workmanship under normal use and service for a period of 24 months from the last day of the week and year whose numbers are printed on the printed circuit board inside these products (hereunder the "**Warranty Period**").

Subject to the provisions of this Warranty Certificate, during the Warranty Period, Crow undertakes, at its sole discretion and subject to Crow's procedures, as such procedures are from time to time, to repair or replace, free of charge for materials and/or labor, products proved to be defective in materials or workmanship under normal use and service. Repaired products shall be warranted for the remainder of the original Warranty Period.

All transportation costs and in-transit risk of loss or damage related, directly or indirectly, to products returned to Crow for repair or replacement shall be borne solely by the Purchaser.

Crow's warranty under this Warranty Certificate does not cover products that is defective (or shall become defective) due to: (a) alteration of the products (or any part thereof) by anyone other than Crow; (b) accident, abuse, negligence, or improper maintenance; (c) failure caused by a product which Crow did not provide; (d) failure caused by software or hardware which Crow did not provide; (e) use or storage other than in accordance with Crow's specified operating and storage instructions.

There are no warranties, expressed or implied, of merchantability or fitness of the products for a particular purpose or otherwise, which extend beyond the description on the face hereof.

This limited Warranty Certificate is the Purchaser's sole and exclusive remedy against Crow and Crow's sole and exclusive liability toward the Purchaser in connection with the products, including without limitation - for defects or malfunctions of the products. This Warranty Certificate replaces all other warranties and liabilities, whether oral, written, (non-mandatory) statutory, contractual, in tort or otherwise.

In no case shall Crow be liable to anyone for any consequential or incidental damages (inclusive of loss of profit, and whether occasioned by negligence of the Crow or any third party on its behalf) for breach of this or any other warranty, expressed or implied, or upon any other basis of liability whatsoever. Crow does not represent that these products can not be compromised or circumvented; that these products will prevent any person injury or property loss or damage by burglary, robbery, fire or otherwise; or that these products will in all cases provide adequate warning or protection.

Purchaser understands that a properly installed and maintained product may in some cases reduce the risk of burglary, fire, robbery or other events occurring without providing an alarm, but it is not insurance or a guarantee that such will not occur or that there will be no personal injury or property loss or damage as a result.

Consequently, Crow shall have no liability for any personal injury; property damage or any other loss based on claim that these products failed to give any warning. If Crow is held liable, whether directly or indirectly, for any loss or damage with regards to these products, regardless of cause or origin, Crow's maximum liability shall not in any case exceed the purchase price of these products, which shall be the complete and exclusive remedy against Crow



12 Kineret Street.  
Airport City, 70100 Israel

Tel. +972 3 9726000  
Fax. +972 3 9726001

sales@crow.co.il  
support@crow.co.il

[www.thecrowgroup.com](http://www.thecrowgroup.com)

These instructions supersede all previous issues in circulation prior to March 2016