

iViewer 03 ECO®

Manual de Instruções
Instruction Manual
Manual de Instrucciones
Manuel D ' Instructions



CE

Os seguintes direitos são reservados:

The following rights are reserved:

Los siguientes derechos están reservados:

Les droits suivants sont réservés:

- Quaisquer alterações, sem aviso prévio, feitas à funcionalidade ou aparência deste produto invalidarão a garantia.
 - Any unannounced changes to the functionality or appearance of this product will void the warranty.
 - Cualquier cambio no anunciado en la funcionalidad o apariencia de este producto anulará la garantía.
 - Toute modification non annoncée de la fonctionnalité ou de l'apparence de ce produit annulera la garantie.
- O uso deste produto em qualquer ambiente ou de qualquer outra forma que não seja especificado aqui também invalidará a garantia.
 - Use of this product in any environment or in any manner not specified herein will also void the warranty.
- El uso de este producto en cualquier entorno o de cualquier manera no especificada en este documento también anulará la garantía.
- L'utilisation de ce produit dans tout environnement ou de toute manière non spécifiée dans les présentes annulera également la garantie.

iViewer 03 ECO®

AVISO

1. Por favor leia este manual cuidadosamente antes de usar o nosso produto.
2. Nunca tente reparar ou modificar o produto ou acessórios por si mesmo, para evitar lesões e invalidar a garantia.
3. Não use produtos químicos para limpar o produto, como álcool ou diluentes.
4. Por favor mude as pilhas logo após o aparecimento do indicador de bateria fraca, de modo a evitar qualquer dano ao produto, que poderia ser causada por derrame da pilha.

na caixa

iViewer 03 HD v2.0 - 1
Saco de ferramentas - 1
Manual - 1

Ecrã LCD

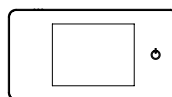

Pilhas AAA

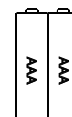

ferramentas

Ecrã LCD - 1
Pilhas AAA - 2
Placa de fixação - 1
Campainha / Camera - 1
Tubo de fixação - 1
Ferramenta de aperto - 1
Parafuso fixação - 1

Placa de fixação



Campainha / Camera

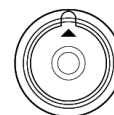

Tubo de fixação

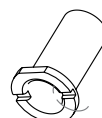

Ferramenta de aperto

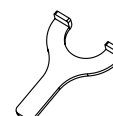

Parafuso de fixação



iViewer 03 ECO[®]

PT

O iViewer 03 Eco[®] é mais económico da sua gama. Contudo, também desempenha a sua função principal com uma grande simplicidade.

CE

instalação

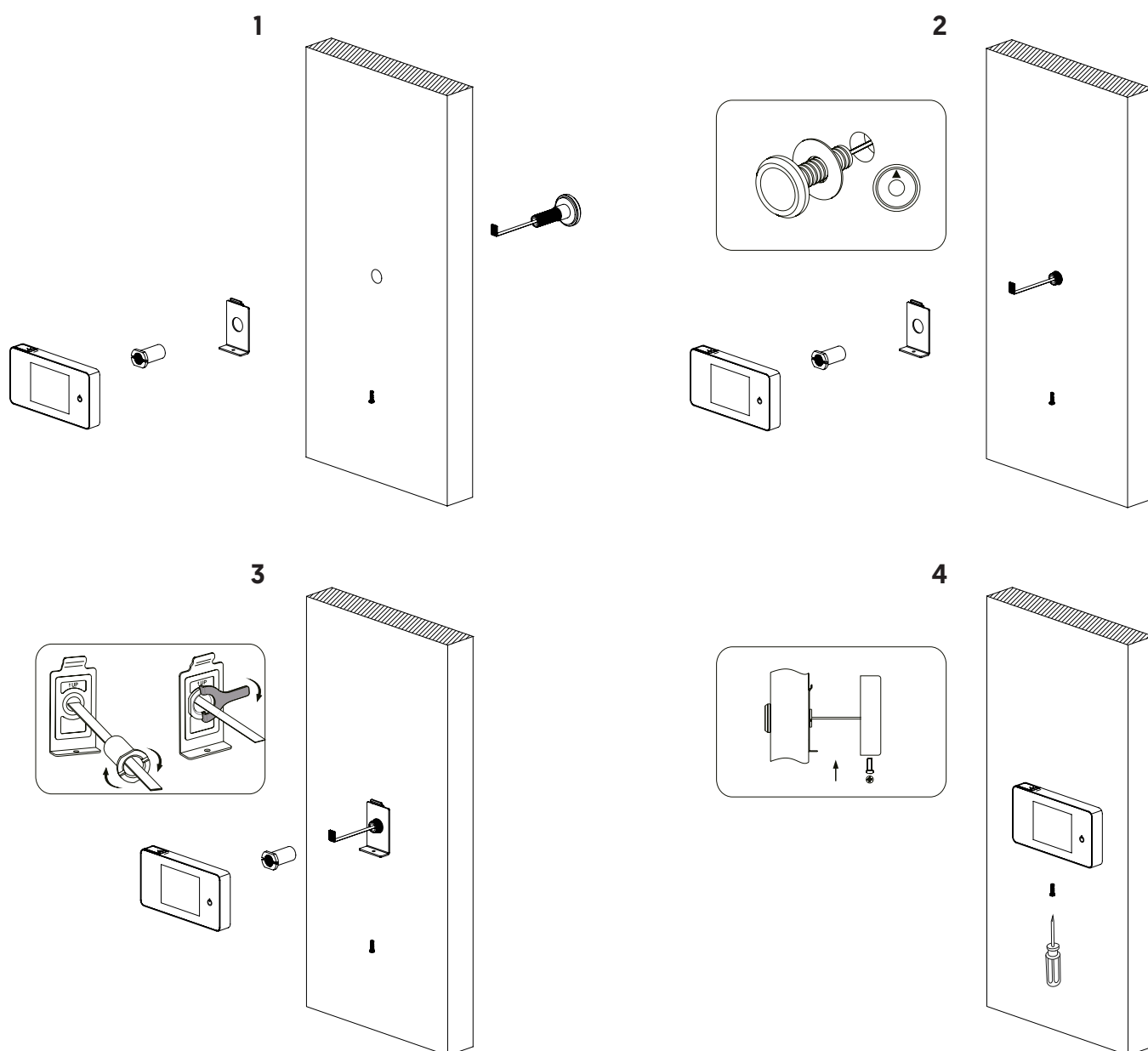

iViewer 03 ECO®

PT

instalação pilhas

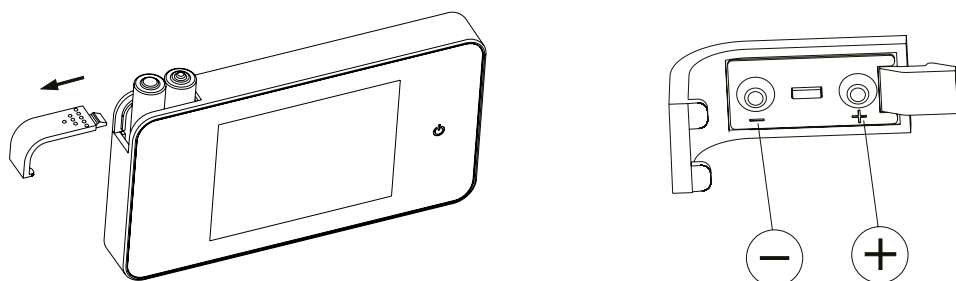

 **Bateria com Carga Total**

 **Bateria Vazia**

O indicador de bateria indica o estado de alimentação. Quando a energia está baixa, as barras de ícones diminuirão. Em algumas baterias recarregáveis, o ícone de status de energia pode ser instável, o que é normal.

Quando as baterias estão esgotadas, o ícone ficará em branco, isso indica que deve substituir as baterias. Os seguintes tipos de baterias podem ser usados neste produto: AA, LR03 1.5V alcalina. Todas as baterias usadas devem ser eliminadas de acordo com os regulamentos locais para proteger o meio ambiente.

especificações

Espessura da porta	38~110mm
Diâmetro furo da porta	14-22mm
Câmara	3 Megapixels HD Def.
Ecrã LCD	2.6" TFT
Energia	2 pilhas AAA
Dimensão	110 (C) x 59(L) x 14(H)mm
Peso	100g

iViewer 03 ECO®

PT

aviso

Certifique-se que monta a câmara compainha da porta com cuidado.

NÃO desmonte a câmara ou dobre os fios. Se os fios da câmara forem puxados ou dobrados isso pode danificar o produto.

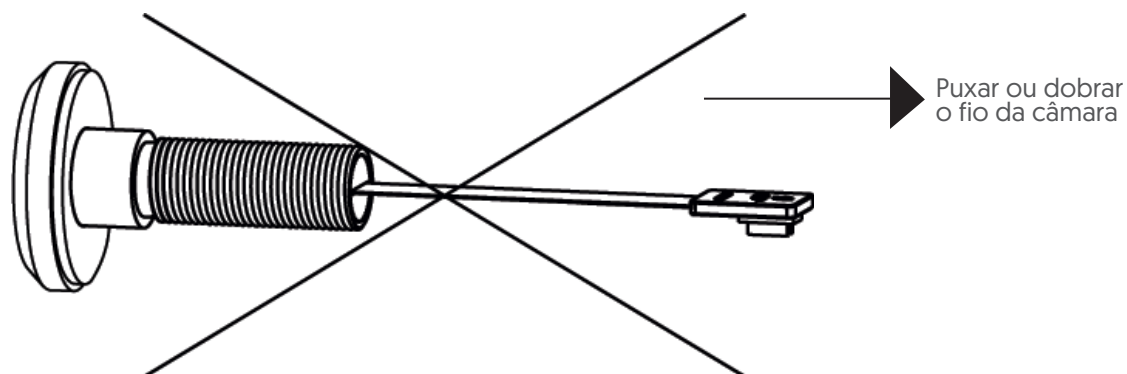

Ao montar a câmara do visor de porta, primeiro desaperte o barril da câmara e insira a mesma na porta para cima. Depois de a câmara estar bem posicionada, aparafuse o mecanismo de fixação do lado de centro da porta. NÃO girar a câmara do lado de fora da porta, isso poderá danificá-la. Também NÃO girar a câmara quando desmontar este produto.

MONTAGEM CORRETA

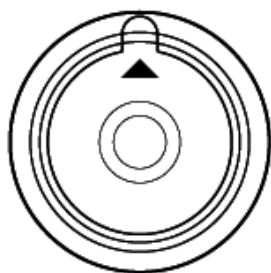

Não girar a câmara da porta durante a montagem

MONTAGEM INCORRETA

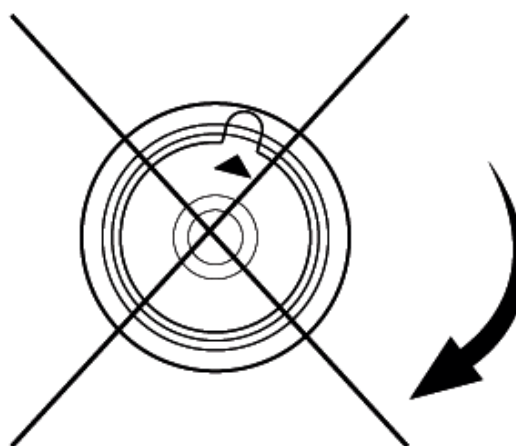

Girar a câmara da porta durante a montagem

POR FAVOR, NÃO TORÇA O VISOR DA PORTA OU O MONITOR, APÓS A CONEXÃO DO CABO.

iViewer 03 ECO®



ATTENTION:

1. Please read this manual carefully before using our product.
2. Never attempt to repair or modify this product or its accessories by yourself, to avoid injury and invalidating guarantee!
3. DO NOT use any chemicals to clean this product, such as alcohol or benzene thinner.
4. Please change the batteries soon after the low-battery indicator shows, in order to avoid any damage to this product which could be caused by battery weeping.

in the box

- iViewer 01 HD v2.0 - 1
- Bag of tools - 1
- Manual - 1

LCD Screen

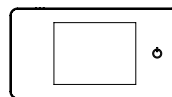

AAA batteries



tools

- LCD Screen - 1
- AAA batteries - 4
- Holding Plate - 1
- Camera - 1
- Locking barrel - 1
- Tightening tool - 1
- Holding screw - 1

Holding Plate



Bell/Camera

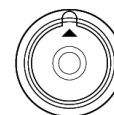

Locking barrel

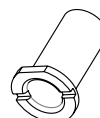

Tightening tool

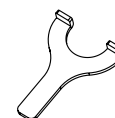

Holding screw



iViewer 03 ECO®

The iViewer 03 Eco® is the more economical in its class. However, it also performs its core function with great simplicity.



installation

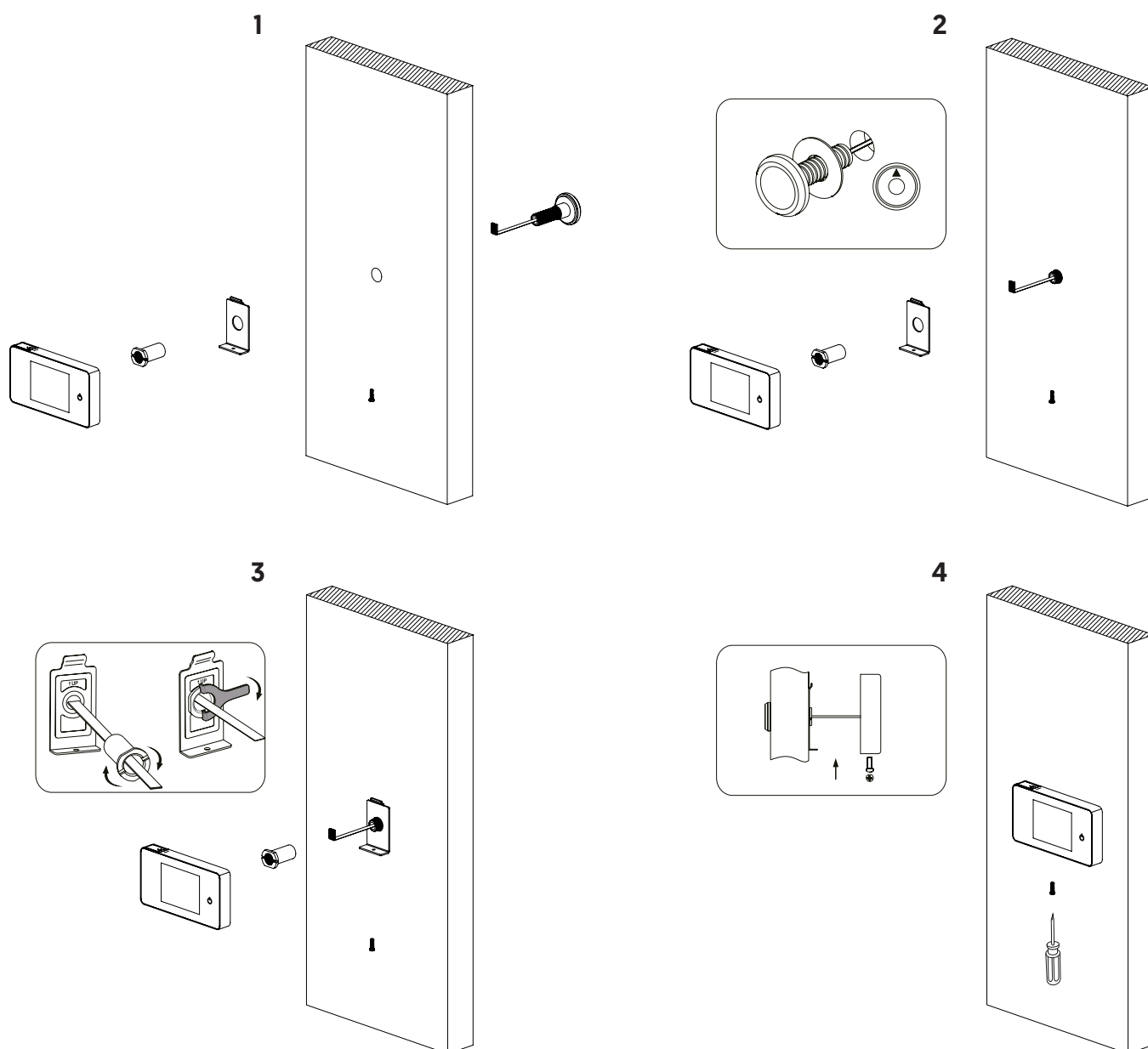

iViewer 03 ECO®

battery change

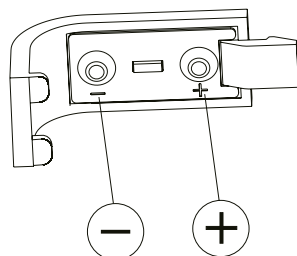
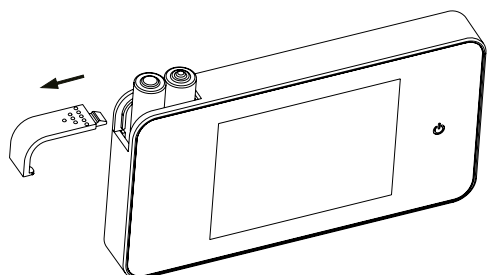

The battery icon shows the power state. When the power is reducing, the bars in the icon will reduce. But as for some dry batteries or rechargeable batteries, the power state in the icon could be unstable, which is normal.

When the batteries run out, this icon will be in blank, which indicates the user to replace the batteries. The following types of batteries can be used in this product: AA, LR03 1.5V alkaline battery. Any abandoned batteries should be disposed according to local environment protection rules and regulations.

specifications

Door thickness	38 ~110mm
Door barrel diameter	14 - 22mm
Camera	3 Megapixels HD Def.
LCD Screen	2.6" TFT
Power	2 AAA batteries
Size	110(W) x 59(H) x 14(D)mm (4.33"x2.32"x0.55")
Weight	100g (4.23 oz)

iViewer 03 ECO®

NE

warning

Make sure you assemble the door bell camera carefully.

DO NOT pull or fold the camera wire. If the camera wire is pulled or folded, this could damage the product.

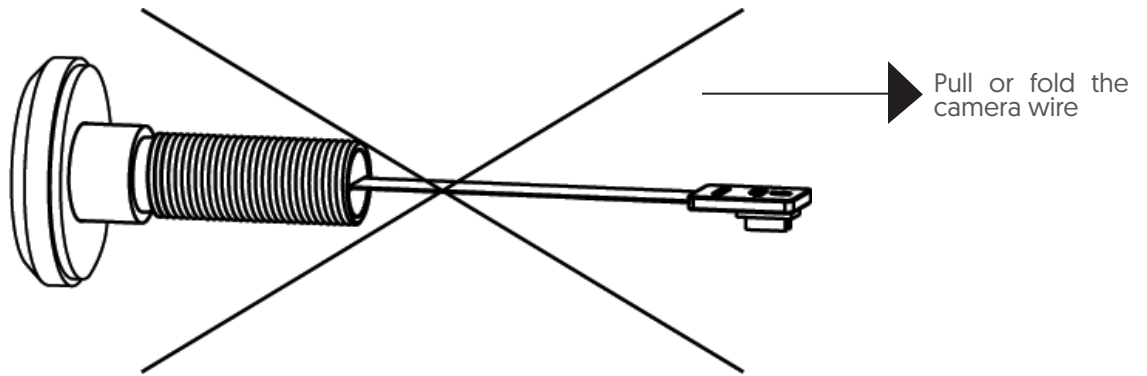

When fitting the door viewer camera, first unscrew the camera barrei and insert the door viewer camera into the peephole with the arrow points up. After the camera is well positioned, screw up the locking barrei from inside door. DO NOT rotate the camera from out side door, this could damage the camera. Also DO NOT rotate camera when disassembling this product.

CORRECT ASSEMBLY

INCORRECT ASSEMBLY

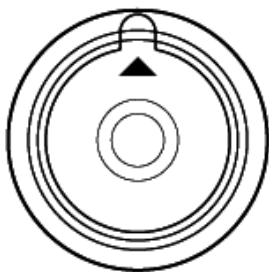

Do not rotate the out door camera when assembling

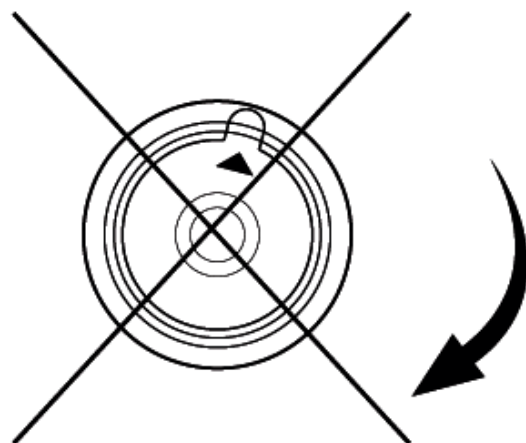

Rotate the out door camera when assembling

Please do not twist the door viewer or the monitor after connecting cable.

iViewer 03 ECO®

ES

ATENCIÓN:

1. Por favor, lea atentamente este manual antes de usar nuestro producto.
2. Nunca intente reparar o modificar el producto o sus accesorios por sí mismo para evitar lesiones y anulará la garantía!
3. No utilice productos químicos para limpiar el producto, tales como alcohol o diluyente benceno.
4. Cambie las baterías después de indicar batería baja, a fin de evitar daños al producto.

en la caja

iViewer 01 HD v2.0 - 1
Bolsa de herramientas - 1
Manual - 1

Pantalla LCD

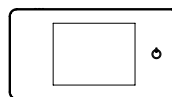

Pilas AAA

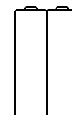

herramientas

Pantalla LCD - 1
Pilas AAA - 4
Placa de montaje - 1
Cámara - 1
Bombín - 1
Herramienta de sujeción - 1
Tornillo de fijación - 1

Placa de montaje

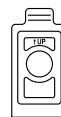

Campana /Cámara

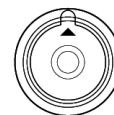

Bombín

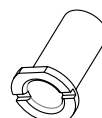

Herramienta de sujeción

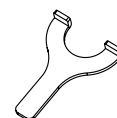

Tornillo de fijación



iViewer 03 ECO®

ES

El iViewer 03 Eco® es más económico en su gama. No obstante, también desempeña a su función principal con una gran simplicidad.

CE

instalación

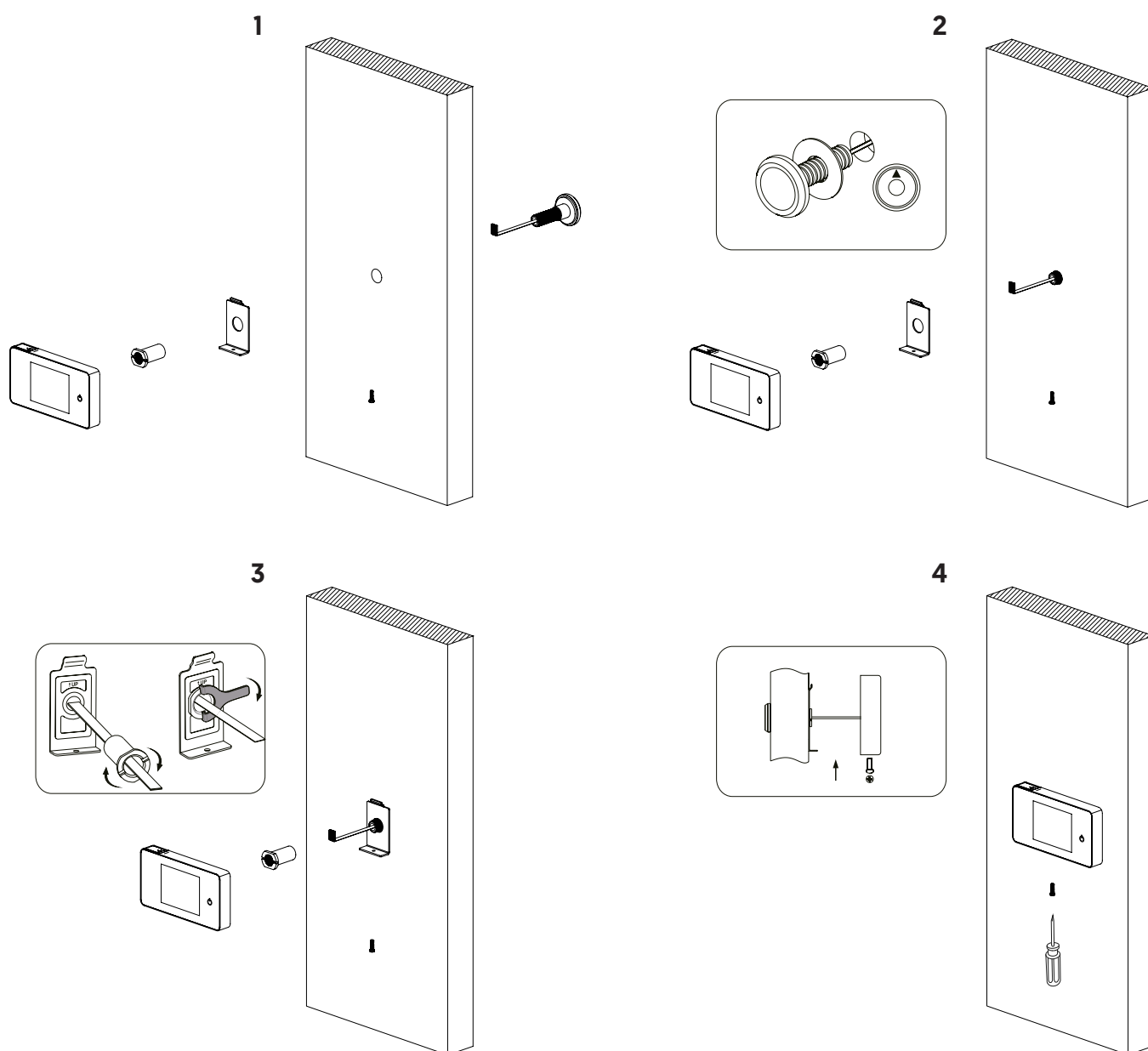

iViewer 03 ECO®

ES

instalación de la batería

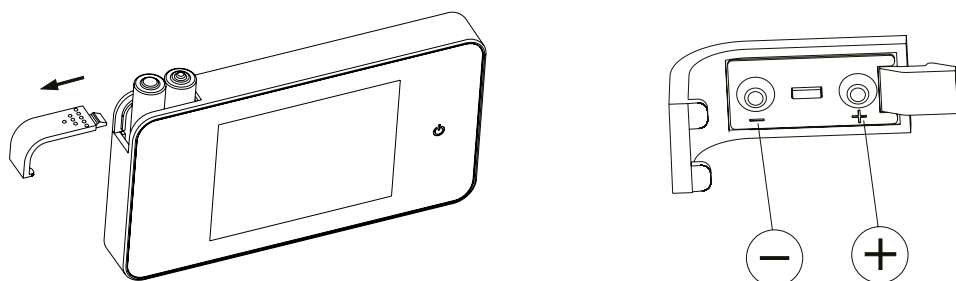

El indicador de batería indica el estado de la alimentación. Cuando la energía está baja, las barras de iconos disminuirán. En algunas baterías recargables, el icono de estado de energía puede ser inestable, lo que es normal.

Cuando las baterías están gastadas, el icono quedará en blanco, eso indica que debe sustituir las baterías. Los siguientes tipos de baterías pueden ser utilizados en este producto: AA LR03 1.5V alcalina. Todas las baterías utilizadas deben ser eliminadas de acuerdo con la regulación local para así proteger el medio ambiente.

especificaciones

Espesura de la puerta	38~110mm
Diámetro agujero de la puerta	14-22mm
Cámara	3 Megapixels HD Def.
Pantalla LCD	2.6" TFT
Energía	2 pilhas AAA
Dimensiones	110 (C) x 59(L) x 14(H)mm
Peso	100g

iViewer 03 ECO®

advertencia

Asegúrese de que la cámara se monta timbre de la puerta con cuidado.

NO desarme la cámara ni tire de los cables.

Si los cables de la cámara son jalados o doblado puede danar el producto.

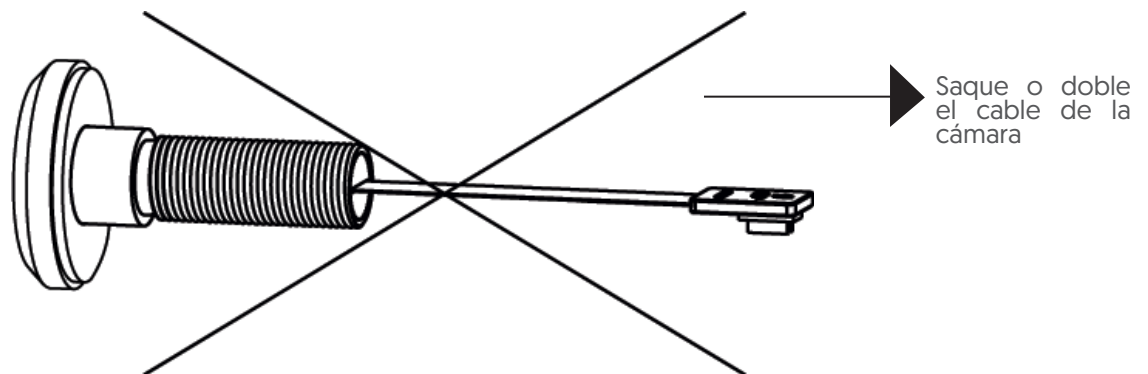

En el montaje de la cámara de espectador de la puerta, retire primero el canón cámara e inserte la cámara en el visor de la puerta dei peephole con la flecha que apunta hacia arriba. Después de que la cámara está bien posicionada, atornille el barril de bloqueo desde el interior de la puerta. No gire la cámara a la puerta dei lado, esta podría danar la cámara. También NO gire la cámara ai desmontar este producto.

MONTAJE CORRECTO

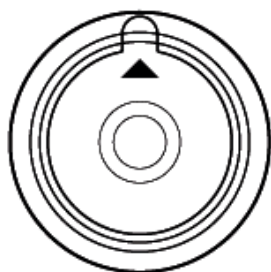

No gire la cámara de la puerta cuando montaje

MONTAJE INCORRECTO

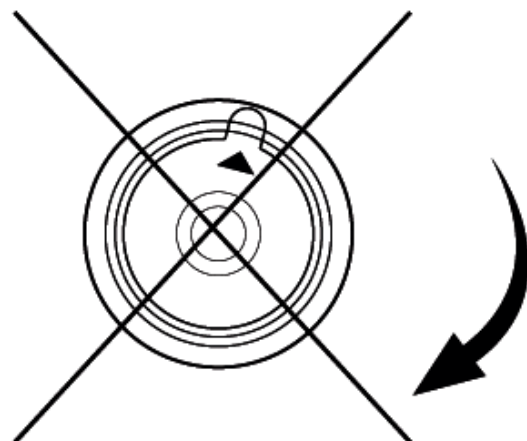

Gire la cámara de la puerta cuando montaje

Por favor, no gire el puerto de pantalla o monitor, después de conectar el cable.

iViewer 03 ECO®

FR

ATTENTION:

1. Merci de lire attentivement ce mode d'emploi avant la première utilisation.
2. Ne jamais réparer ou modifier ce produit ou ses accessoires par vous même, tout risque de blessures ainsi que invalider la garantie!
3. Ne pas utiliser produits chimiques pour nettoyer ce viseur électronique, tels que l'alcool ou de diluant.
4. Nous vous conseillons de changer les piles dès que l'indicateur du niveau des piles le signale, afin d'éviter une fuite des piles.

dans la boîte

iViewer 01 HD v2.0 - 1
 Sac à outils - 1
 Manuel - 1

**Viseur
électronique**

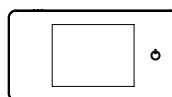

Piles AAA

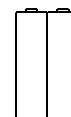

des outils

Viseur électronique - 1
 Piles AAA - 4
 Plaque de maintien - 1
 Caméra - 1
 Barillet de verrouillage - 1
 Outil de serrage - 1
 Vis de fixation - 1

**Plaque de
maintien**



**Campainha
/ Caméra**

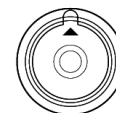

**Barillet de
verrouillage**

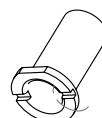

**Outil de
serrage**

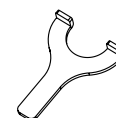

Vis de fixation



iViewer 03 ECO®

FR

L'iViewer 03 Eco® est le plus économique de sa catégorie. Cependant, il exécute également sa fonction principale avec une grande simplicité.

CE

L'installation

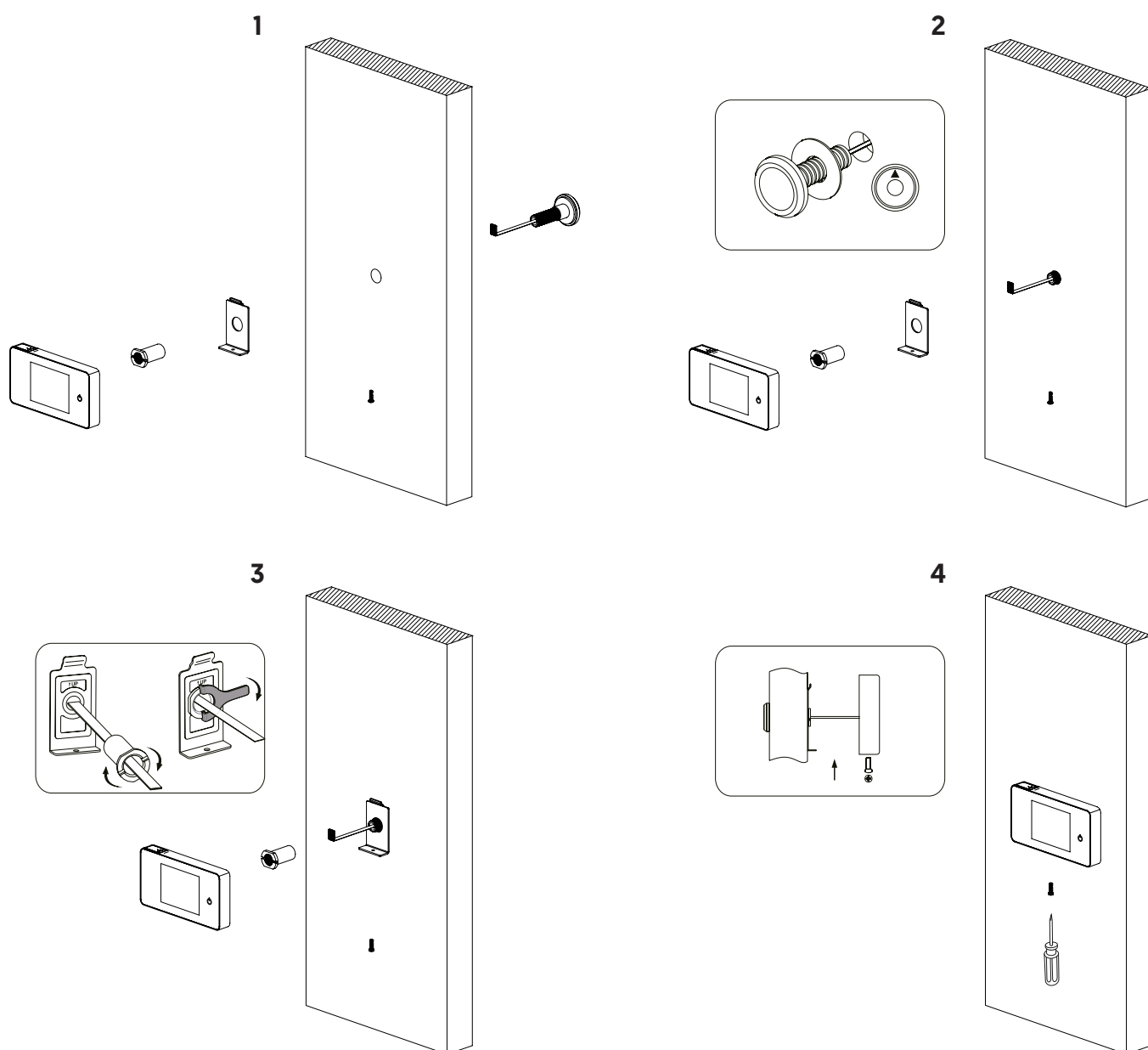

iViewer 03 ECO®

FR

installation de la batterie

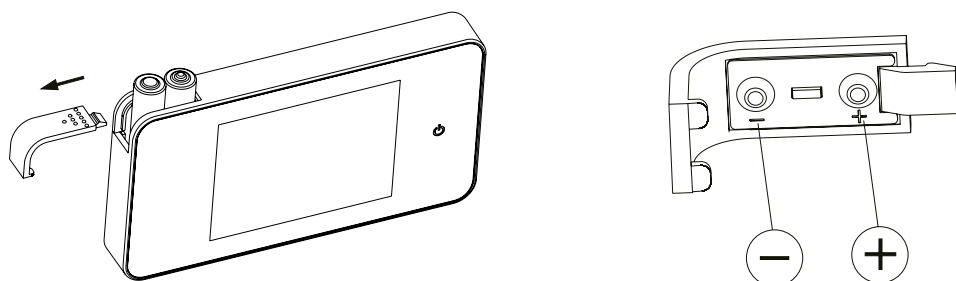
**Batterie chargée****Batterie vide**

La jauge de la batterie indique l'état de l'alimentation. Lorsque l'énergie est faible, les barres d'icônes diminuent. Pour certaines batteries rechargeables, l'icône d'état d'alimentation peut être instable, ce qui est normal.

Lorsque les piles sont épuisées, l'icône sera vide, cela indique à l'utilisateur de remplacer les piles. Les types suivants de piles peuvent être utilisés dans cet appareil: AA, LR03 1.5V alcalines. Toutes les piles vides doivent être éliminées selon les règles locales de protection de l'environnement.

spécifications

Épaisseur de porte	38 ~110mm
Diamètre du trou	14 - 22mm
Caméra	3 Megapixels HD Def.
LCD Ecran	2.6" TFT
Alimentation	2 piles AAA
Dimension	110(L) x 59(Larg.) x 14(P)mm
Poids	100g

iViewer 03 ECO®

FR

avertissement

Assurez-vous de respecter les consignes d'installation du matériel.

NE démontez PAS l'appareil ou ne tirez pas sur les fils, ce qui pourrait endommager le matériel.

Si les fils de la caméra sont tirés ou pliés cela pourra endommager le produit.

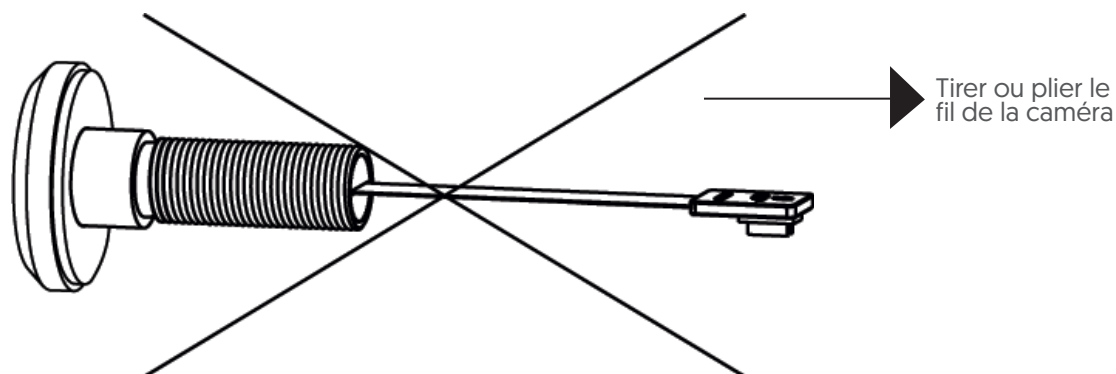

Lors du montage de la caméra du viseur de porte, dévissez d'abord le canon de l'appareil photo et insérez-le dans la porte avec la fleche pointant vers le haut. Après avoir pris soin de bien positionner l'appareil, vissez le mécanisme de fixation du coté intérieur. Ne faites pas pivoter la caméra du côté extérieur de la porte, au risque d'endommager l'appareil. De la même manière, ne pas faire pivoter la caméra lors du démontage du matériel.

ASSEMBLAGE CORRECT

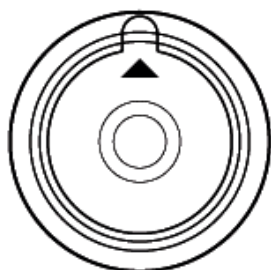

Ne pas faire pivoter la caméra sur la porte lors de l'assemblage.

ASSEMBLAGE INCORRECT

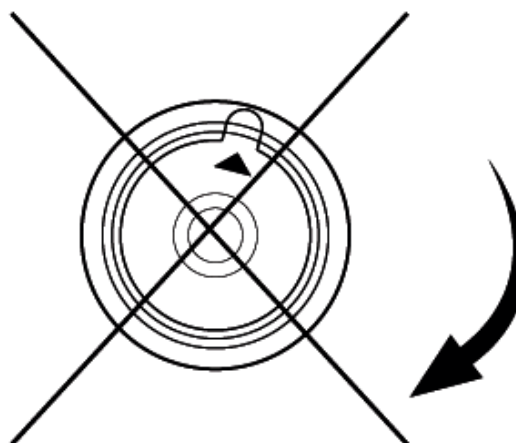

Faites pivoter la caméra sur la porte lors de l'assemblage.

Veillez à ne pas faire pivoter le viseur une fois que les câbles sont connectés.



iTEC - AC, Lda.
Edifício FeiraPark
Rua do FeiraPark nº50
4520-632 São João de Ver
Portugal



Telefone: +351 256 30 70 78
Telefone: +351 256 30 70 80
comercial@itec.com.pt