

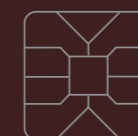

WHO WHEN WHERE

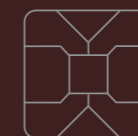

WHERE WHEN WHO ● WHERE WHEN WHO ● WHERE
WHO ● WHERE WHEN WHO ● WHERE WHEN WHO ●
WHEN WHO ● WHERE WHEN WHO ● WHERE WHEN
WHERE WHEN WHO ● WHERE WHEN WHO ● WHERE
WHO ● WHERE WHEN WHO ● WHERE WHEN WHO ●



Bem vindo à ITEC
Welcome to ITEC

Bienvenido a ITEC
Bienvenue à ITEC

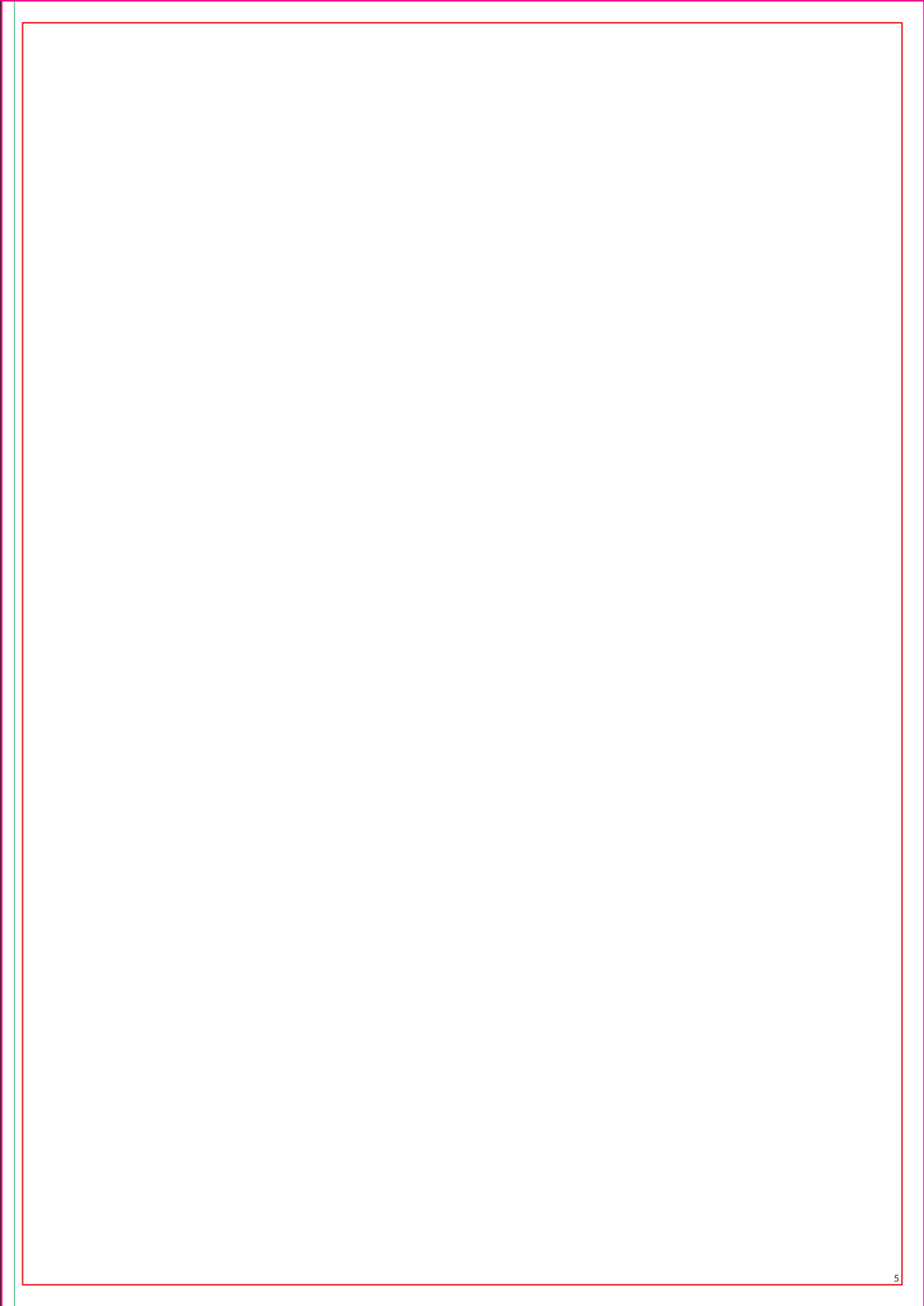
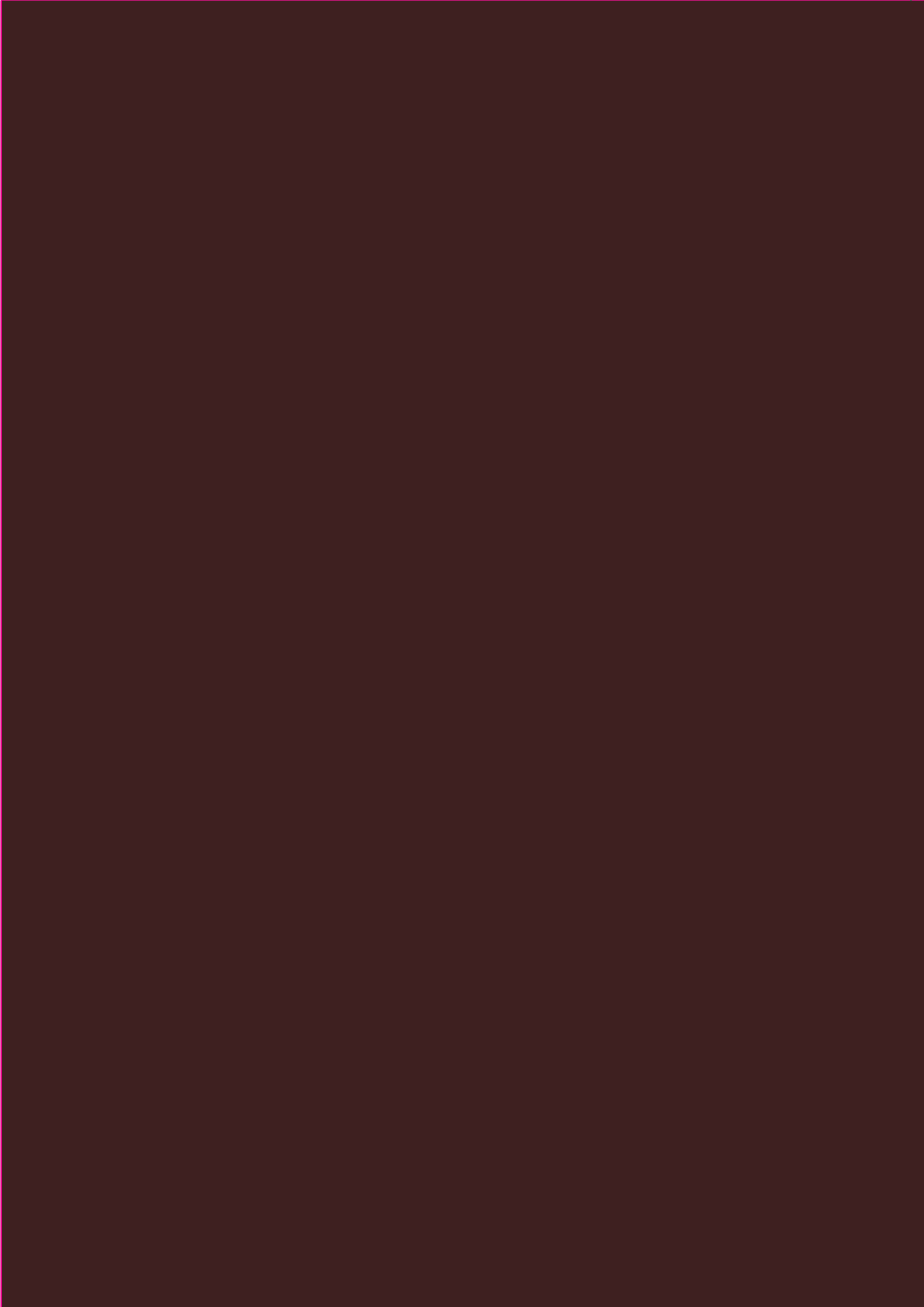



iTEC Equipa de Trabalho | iTEC Work Team

Equipo de trabajo iTEC | Équipe de travail iTEC

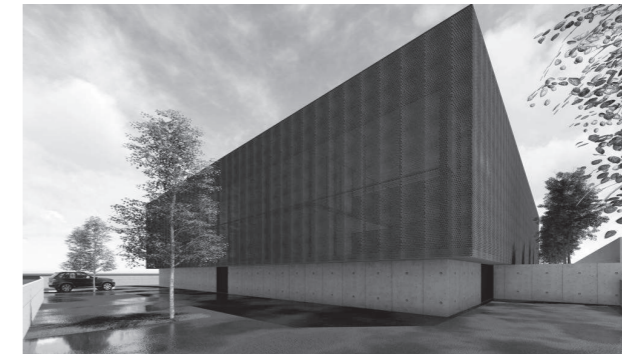

A História

The History | La Historia | L'histoire

pt. A história da iTEC reporta aos seus antepassados, mais precisamente ao ano de 1937, estando já na 3ª geração na área de negócio, centrada no Controlo de Acessos e revolucionária em sistemas mecânicos e mecatrónicos. Ou seja, emergindo no meio tecnológico de informação, a iTEC funciona como um elemento cooperante e activo no dia-a-dia da segurança e da actividade Humana.

A empresa nasce de uma longa trajetória e experiência profissional. Alcides Alves de Castro reúne uma equipa multidisciplinar para atender às necessidades e condicionantes do mercado por meio de pesquisas, produção e contactos na área de Controlo de Acesso. Desta forma, as bases de progresso foram marcadas por premissas como: inovação, segurança, tecnologia, mercado, preocupação social, viagens de negócios, qualidade e satisfação do cliente.

en. The history of iTEC reports to their ancestors, more precisely in the year 1937, it's already in the 3rd generation in Access Control Business, focused on Access Control and revolutionary in mechanical and mechatronic systems. In other words, iTEC emerges from technological information as a cooperative and active element in the day- to-day security of Human activity.

The company is born from a long career and professional experience. Alcides Alves de Castro gathers a multidisciplinary team to meet the market needs and conditions through research, production and contacts in the Access Control area. In this way, the bases of progress were marked by premises such as: innovation, safety, technology, market research, social concern, business travel, quality and customer satisfaction.

As empresas, mais do que as pessoas, Companies, more than people, têm uma margem menor de falha. have smaller margin for failure.

No futuro, apenas empresas que acreditam em planos estratégicos, believe in strategic plans, adaptability adaptabilidade e "gestão do caos" and "chaos management" will alcançarão a excelência! achieve excellence!

es. La historia de iTEC informa a sus antepasados, más precisamente en el año 1937, ya se encuentra en la 3ª generación en el Negocio de Control de Accesos, enfocado al Control de Accesos y revolucionario en sistemas mecánicos y mecatrónicos. Es decir, iTEC surge de la información tecnológica como un elemento cooperativo y activo en la seguridad del día a día de la actividad humana.

La empresa nace de una larga trayectoria y experiencia profesional. Alcides Alves de Castro reúne un equipo multidisciplinar para satisfacer las necesidades y condiciones del mercado a través de la investigación, producción y contactos en el área de Control de Accesos. De esta forma, las bases del progreso estuvieron marcadas por premisas como: innovación, seguridad, tecnología, investigación de mercado, inquietud social, viajes de negocios, calidad y satisfacción del cliente.

fr. L'histoire d'iTEC rapporte à leurs ancêtres, plus précisément en 1937, elle fait déjà partie de la 3ème génération dans le domaine du contrôle d'accès, axée sur le contrôle d'accès et révolutionnaire dans les systèmes mécaniques et mécatroniques. En d'autres termes, iTEC émerge de l'information technologique comme un élément coopératif et actif dans la sécurité quotidienne de l'activité humaine.

L'entreprise est née d'une longue histoire et d'une expérience professionnelle. Alcides Alves de Castro rassemble une équipe multidisciplinaire pour satisfaire les besoins et les conditions du marché à travers la recherche, la production et les contacts dans le domaine du contrôle d'accès. Ainsi, les fondements du progrès ont été marqués par des prémisses telles que : l'innovation, la sécurité, la technologie, les études de marché, le social, les déplacements professionnels, la qualité et la satisfaction client.

Las empresas, más que las personas, Les entreprises, plus que les personnes, han menor margen de falla. ont marge d'échec plus faible.

En el futuro, solo las empresas que crean en planes estratégicos, croire aux plans stratégiques, à adaptabilidad y la "gestión del caos" l'adaptabilité et la « gestion alcanzar la excelencia! du chaos»atteindre l'excellence !

“Simplicidade é a sofisticação mais elevada”

Simplicity is the highest sophistication | La simplicidad es la máxima sofisticación | La simplicité est la plus haute sophistication

pt. Hoje, vivemos num mundo onde o tempo se tem tornado mais curto e por isso, mais valioso. Neste sentido a iTEC direciona a sua estratégia na busca de soluções simples, eficazes, confortáveis e sustentáveis.

Por meio da tecnologia online em tempo real, o utilizador monitora e gerencia as informações. A evolução contínua da iTEC, oferece soluções que se distinguem desde o simples controlo de uma fechadura de armário, configuração de todos os acessos com ou sem software até ao sistema completo de controlo de acessos, nomeadamente código digital, leitura biométrica, QR Code, NFC e dispositivo móvel.

en. Today, we live in a world where time is becoming shorter and more valuable. In this sense iTEC directs its strategy in seeking simple, comfortable and sustainability solutions.

Through online real-time online technology, the user monitoring and management the information. The continuous evolution of iTEC, offer solutions that are distinguished from simple control of a cabinet lock- configuration of all access with or without software- up to the complete access control system, namely digital code, biometric reading, QR Code, NFC and mobile device integration.

Visão

Vision | Visión | Vision

pt. A iTEC trabalha para ser uma empresa líder a nível internacional e reconhecida pela qualidade e diversidade dos produtos e soluções oferecidos na área de Controlo de Acessos. Para obter os melhores resultados, a empresa foca-se na evolução e aumento da equipa.

en. iTEC works towards being a internationally leading company and being recognized for the quality and diversity of products and solutions offered in the Access Control area. For the best results, the company focuses team's evolution and increase.

es. Hoy vivimos en un mundo donde el tiempo es cada vez más corto y valioso. En este sentido iTEC orienta su estrategia en la búsqueda de soluciones sencillas, cómodas y sostenibles.

A través de la tecnología en línea en tiempo real, el usuario monitorea y administra la información. La continua evolución de iTEC, ofrece soluciones que se distinguen desde el simple control de una cerradura de armario -configuración de todos los accesos con o sin software- hasta el sistema completo de control de acceso, es decir, código digital, lectura biométrica, código QR, NFC y dispositivo móvil integración.

fr. Aujourd'hui, nous vivons dans un monde où le temps devient plus court et plus précieux. En ce sens, iTEC oriente sa stratégie vers la recherche de solutions simples, confortables et durables.

Grâce à la technologie en ligne en temps réel, l'utilisateur surveille et gère les informations. L'évolution continue d'iTEC, offre des solutions qui se distinguent du simple contrôle d'une serrure d'armoire - configuration de tous les accès avec ou sans logiciel - jusqu'au système de contrôle d'accès complet, à savoir code numérique, lecture biométrique, QR Code, NFC et appareil mobile l'intégration.

es. iTEC trabaja para ser una empresa líder a nivel internacional y ser reconocida por la calidad y diversidad de productos y soluciones que ofrece en el área de Control de Accesos. Para obtener los mejores resultados, la empresa se centra en la evolución y el aumento del equipo.

fr. iTEC s'efforce d'être une entreprise leader au niveau international et d'être reconnue pour la qualité et la diversité des produits et solutions proposés dans le domaine du contrôle d'accès. Pour les meilleurs résultats, l'entreprise se concentre sur l'évolution de l'équipe.

Valores

Values | Valores | Valeurs

<p>01</p> <p>Ética Ethic Moral Éthique</p>	<p>02</p> <p>Compromisso, Colaboração Commitment, Collaboration Compromiso, Colaboración Engagement, Collaboration</p>	<p>03</p> <p>Excelência Excellence Excelencia Excellence</p>	<p>04</p> <p>Integridade, Respeito Integrity, Respect Integridad, Respeto Intégrité, Respect</p>
<p>05</p> <p>Valorização Humana Human Valorization Valorización Humana Valorisation Humaine</p>	<p>06</p> <p>Inovação Innovation Innovación Innovation</p>	<p>07</p> <p>Responsabilidade Social Social Responsibility Responsabilidad Social Responsabilité Sociale</p>	<p>08</p> <p>Sustentabilidade Sustainability Sustentabilidad Durabilité</p>

Composição da equipa

The Composition of our team | La composición de nuestro equipo | La composition de notre équipe



Idade média dos trabalhadores
Average age of workers
Edad promedio de las trabajadoras
Âge moyen des travailleurs



Total de Vendas

Sales amount | Cantidad de ventas | Montant des ventes

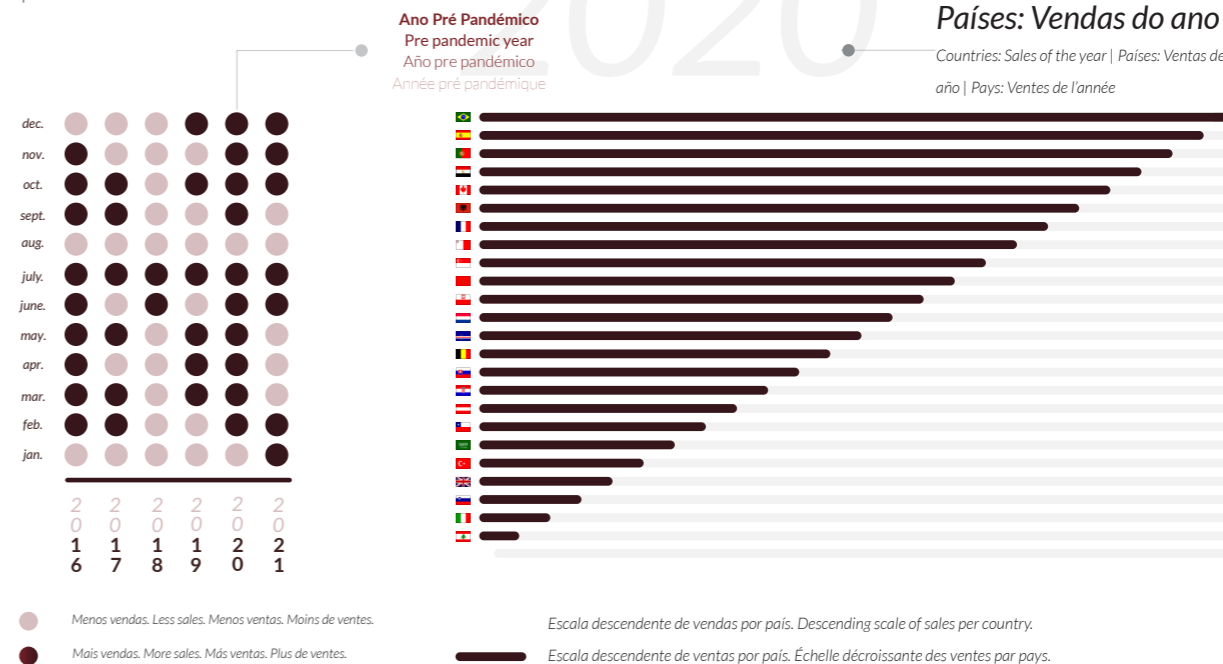

Ano Pré Pandémico
Pre pandemic year
Año pre pandémico
Année pré pandémie

Países: Vendas do ano

Countries: Sales of the year | Paises: Ventas del año | Pays: Ventes de l'année

Escala descendente de vendas por país. Descending scale of sales per country.

Escala descendente de vendas por país. Échelle décroissante des ventes par pays.

trabalho

Método de ...

Method of Work | Método de trabajo | Méthode de travail

<p>Investigação Investigation Investigación Enquête</p>	<p>Desenvolvimento Development Desarrollo Développement</p>	<p>Personalização Customization Personalización Personnalisation</p>	<p>Projeto Project Proyecto Projet</p>
<p>Revisão Review Revisión Revoir</p>	<p>Produção Production Producción Production</p>	<p>Embalamento Packaging Embalaje Emballage</p>	<p>Exportação Exportation Exportación Exportation</p>

iTEC no Mundo

iTEC WorldWide | iTEC en todo el mundo | iTEC dans le monde

- Austria
- Croatia
- Slovakia
- China
- France
- Spain
- Georgia
- Greece
- Iceland
- Poland
- Switzerland
- Netherlands
- Romania
- Mali
- Senegal
- Australia
- Turkey
- Maroc

pt. A iTEC está espalhada pelo globo: clientes, revendedores da marca, parceiros, residências, prédios públicos, escolas, entre outros. Resolve as lacunas do mercado, apresenta soluções inteligentes e adequadas e manifesta-se de acordo com as suas pertinentes necessidades.

en. iTEC is scattered across globe: customers, dealer of the brand, partners, residences, public buildings, schools, among others. Solves the gaps in the market, presents intelligent and appropriate solutions.

es. iTEC se encuentra disperso por todo el mundo: clientes, distribuidor de la marca, socios, residencias, edificios públicos, escuelas, entre otros. Soluciona los vacíos del mercado, presenta soluciones inteligentes y adecuadas y se comporta de acuerdo a las necesidades.

fr. iTEC est dispersé à travers le monde: clients, partenaires, résidences, revendeur de la marque, bâtiments publics, écoles, entre autres. Résout les lacunes du marché, présente des solutions intelligentes et appropriées.

- USA
- Canada
- Brasil
- Colombia
- Panama
- United Kingdom
- Germany
- South Africa
- Angola
- Cuba



Americas

Africa

EMEA

Asia Pacific

Referências (exemplos)

References (examples) | Referencias (ejemplos) | Références (exemples)

Portugal

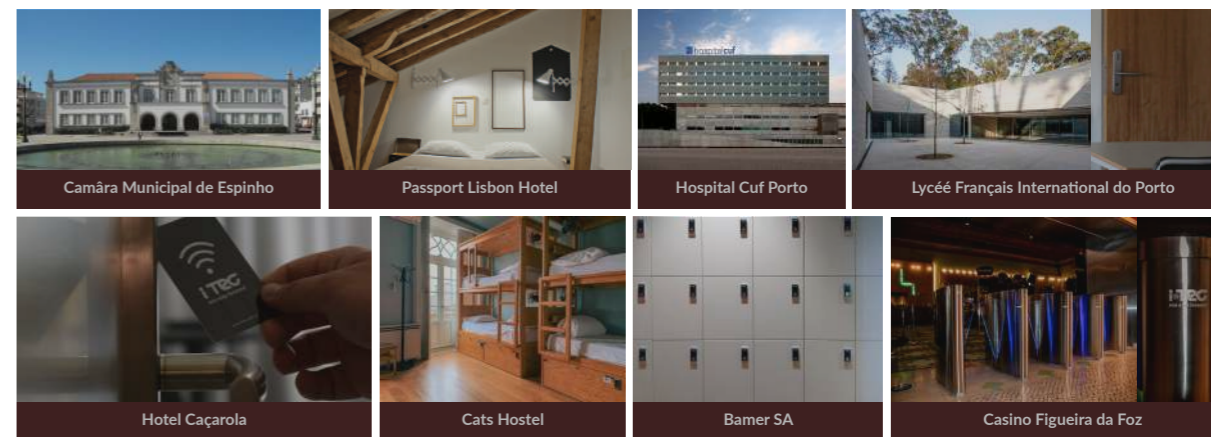

Spain

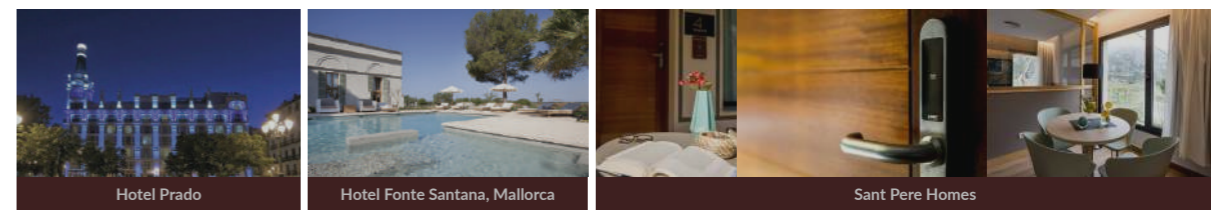

Brazil

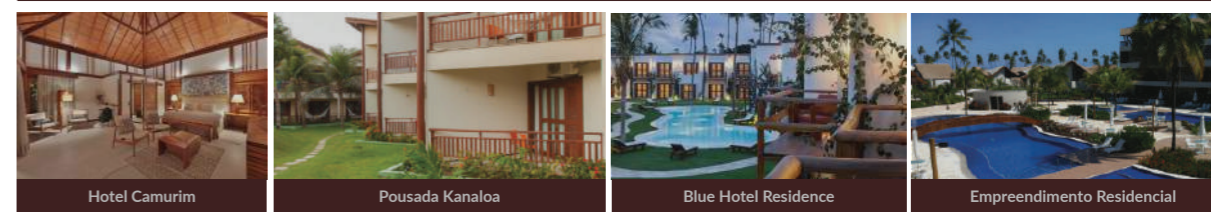

Cuba

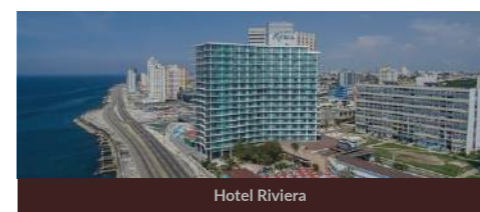

Turkey

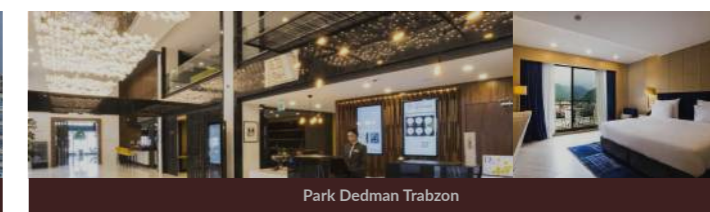

Poland

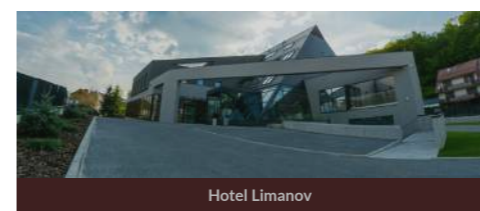

Netherlands





iTEC Hybrid

Access Control Software | Software de Control de Acceso | Logiciel de Contrôle D'accès

pt. iTEC Hybrid® é um software para Controlo de Acesso. Pode ser integrado em praticamente todos os terminais existentes e em diversos contextos de acessos. Pode configurar várias zonas de acesso, definir grupos com diferentes níveis e planos de acesso. Com opção de gerar relatórios de acesso e controlar as rondas, o iTEC Hybrid® apresenta um painel de controlo de movimento. A possibilidade de implementação de funções como plantas e mapas 2D compatível para integrar sistemas de vídeo vigilância e reconhecimento de matrículas, faz do iTEC Hybrid® um software dedicado para ser a solução da sua necessidade.

en. iTEC Hybrid® is a software for Access Control. It can be integrated with virtually all existing terminals and in various access contexts. You can configure multiple access zones, define groups with different levels and access plans. With the option to generate access reports and control tours, iTEC Hybrid® features a motion control panel. Compatible 2D plan and map deployment functionality to integrate video surveillance and license plate recognition systems makes iTEC Hybrid® a dedicated software to be the solution to your need.

es. iTEC Hybrid® es un software para control de acceso. Se puede integrar con prácticamente todos los terminales existentes y en diversos contextos de acceso. Puede configurar múltiples zonas de acceso, definir grupos con diferentes niveles y planes de acceso. Con la opción de generar informes de acceso y recorridos de control, iTEC Hybrid® presenta un panel de control de movimiento. La funcionalidad de implementación de planos y mapas 2D compatibles para integrar sistemas de videovigilancia y reconocimiento de matrículas convierte a iTEC Hybrid® en un software dedicado para ser la solución de sus necesidades.

fr. iTEC Hybrid® est un logiciel de contrôle d'accès. Il peut être intégré à pratiquement tous les terminaux existants et dans divers contextes d'accès. Vous pouvez configurer plusieurs zones d'accès, définir des groupes avec différents niveaux et plans d'accès. Avec la possibilité de générer des rapports d'accès et des visites de contrôle, iTEC Hybrid® dispose d'un panneau de commande de mouvement. La fonctionnalité de déploiement de plans et de cartes 2D compatibles pour intégrer la surveillance vidéo et les systèmes de reconnaissance de plaques d'immatriculation fait d'iTEC Hybrid® un logiciel dédié pour être la solution à votre besoin.



iTEC Hybrid

Access Control Software | Software de Control de Acceso | Logiciel de Contrôle D'accès

Recurso de Controlo Híbrido

Hybrid Control Resource | Recurso de Control Híbrido | Ressource de Contrôle Hybride

pt. Máximo número de portas •

Máximo número de utilizadores por porta •

Máximo número de portas por sistema •

Fuso horário no sistema •

Calendário no sistema •

en. Maximum number of doors •

Maximum number of users per door •

Maximum number of doors per system •

Timezone in system •

Calendar in system •

es. Número máximo de puertas •

Número máximo de usuarios por puerta •

Número máximo de puertas por sistema •

Zona horaria en el sistema •

Calendario en el sistema •

es. Nombre maximum de portes •

Nombre maximum d'utilisateurs par porte •

Nombre maximum de portes par système •

Fuseau horaire dans le système •

Calendrier dans le système •

● Limitado pelo Hardware.
Limited to the Hardware.
Limitado al hardware.
Limité au matériel.

● Ilimitado.
Unlimited.
Ilimitada.
Illimitée.

Uso diário do iTEC Hybrid

Daily Use of iTEC Hybrid | Uso Diario de iTEC Híbrido | Quotidienne d'iTEC Hybrid

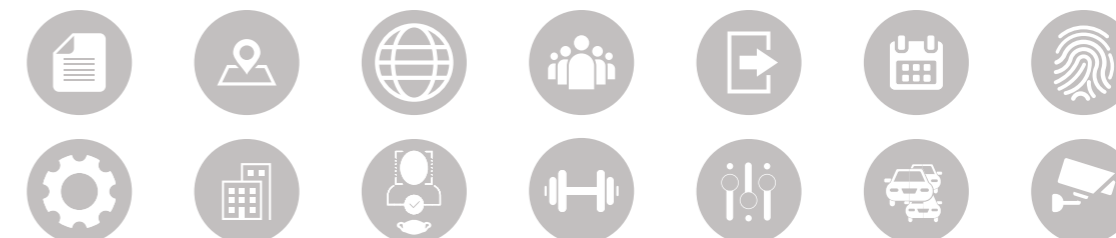

iTEC OnAccess

App & Desktop Web Browser | Aplicación y Desktop Web Navegador | Navigateur Web D'application

pt. Com a iTEC OnAccess, tem a certeza de que toda a gestão dos seus acessos é feita com total segurança, através do seu dispositivo móvel. Você decidirá quem, quando e onde terá acesso: à sua porta, garagem, escritório, edifício, etc...

en. With iTEC OnAccess, you are assured that all your access management is handled with total security through your mobile device. You will decide who, when and where you will have access: at your door, garage, office, building, etc...

es. Con iTEC OnAccess, tiene la seguridad de que toda su gestión de acceso se gestiona con total seguridad a través de su dispositivo móvil. Usted decidirá quién, cuándo y dónde tendrá acceso: en su puerta, garaje, oficina, edificio, etc...

fr. Avec iTEC OnAccess, vous êtes assuré que toute votre gestion des accès est gérée avec une sécurité totale via votre appareil mobile. Vous déciderez à qui, quand et où vous aurez accès: à votre porte, garage, bureau, immeuble, etc...

iTEC OnAccess Pro

App & Desktop Web Browser | Aplicación y Desktop Web Navegador | Navigateur Web D'application

pt. iTEC OnAccess Pro, é uma expansão da APP iTEC OnAccess, onde para além de poder controlar os seus acessos remotamente, poderá geri-los por grupos e planos de trabalho. Poderá controlar todas as necessidades como a gestão do pessoal, serviços de manutenção e de limpeza, com a facilidade de poder fazer isto tudo remotamente através do seu dispositivo móvel ou pelo web browser no seu computador.

en. iTEC OnAccess Pro, is an expansion of the iTEC OnAccess APP, where in addition to being able to control your accesses, you can manage them by groups and work plans. Control all mobile needs such as staff management, maintenance and cleaning services, easily via your device or the web browser on your computer.

es. iTEC OnAccess Pro, es una expansión de la APP iTEC OnAccess, donde además de poder controlar tus accesos de forma remota, podrás gestionarlos por grupos y planes de trabajo. Podrás controlar todas las necesidades como la gestión de personal, el mantenimiento y los servicios de limpieza, con la facilidad de poder hacerlo todo de forma remota a través de tu dispositivo móvil o a través del navegador web de tu ordenador.

es. iTEC OnAccess Pro, est une extension de l'application iTEC OnAccess, où en plus de pouvoir contrôler vos accès à distance, vous pouvez les gérer par groupes et plans de travail. Vous pourrez contrôler tous les besoins tels que la gestion du personnel, les services de maintenance et de nettoyage, avec la facilité de pouvoir faire tout cela à distance via votre appareil mobile ou via le navigateur Web de votre ordinateur.

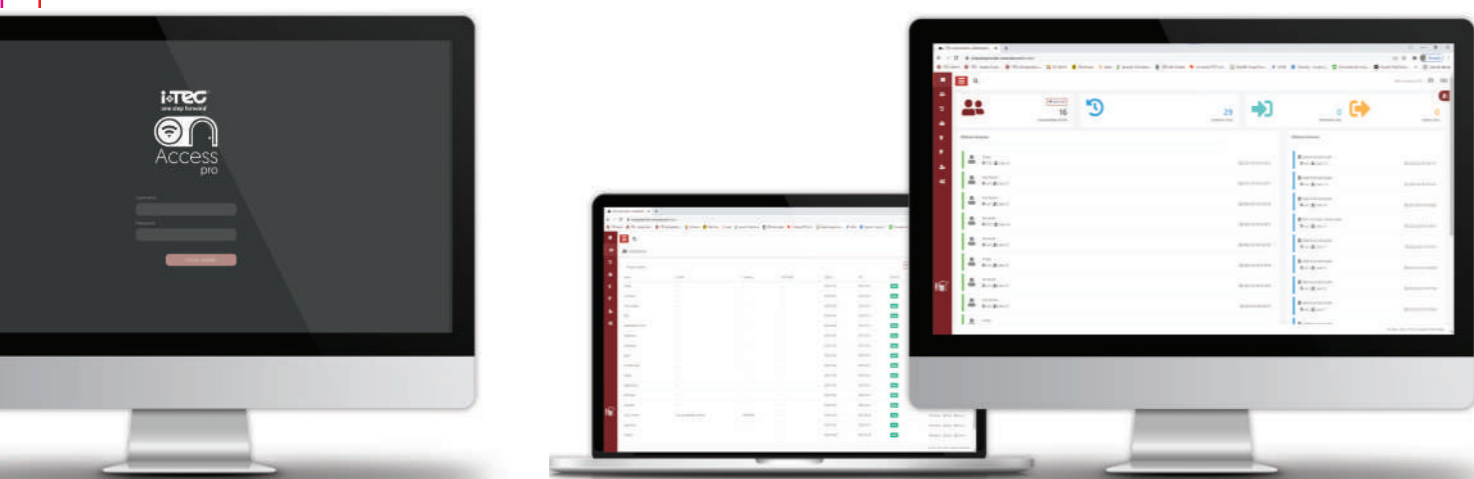

iTEC OnHospitality

Hotel Management | Gestión Hotelera | Gestion de l'hôtel

pt. O iTEC OnHospitality, é uma ferramenta de gestão hoteleira com uma interface moderna, responsiva, intuitiva e segura, para uma gestão simples e eficiente! O software permite a criação de modelos de cartões de acesso, com a máxima qualidade e segurança nos serviços. Do cartão mestre, que permite abrir todas as fechaduras do seu Hotel, até à limitação simples de abertura da fechadura por número de utilizações. O software pode ser acedido através de um computador da rede, as suas funcionalidades estão interligadas, sendo possível saber se o espaço está a ser utilizado, em manutenção, em limpeza ou desocupado. Tem ainda funções como, calendarização de eventos, reservas, fazer check-ins e check-outs, gestão de ocupação, gestão de elementos de staff, integração com o SEF. Um software com uma interface responsiva e com partilha de informação em tempo real!

en. iTEC OnHospitality is a hotel management tool with a modern, responsive, intuitive and secure interface for simple and efficient management! The software allows the creation of access card templates, with maximum quality and security in services. From the master card, which allows you to open all the locks of your Hotel, to the simple limitation of opening the lock by number of uses.

The software can be accessed through a computer on the network, its functionalities are interconnected, making it possible to know if the space is being used, in maintenance, cleaning or unoccupied. It also has functions such as event scheduling, reservations, check-ins and check-outs, occupancy management, staff management. A software with a responsive interface and real-time information sharing!

es. iTEC OnHospitality es una herramienta de gestión hotelera con una interfaz moderna, receptiva, intuitiva y segura para una gestión simple y eficiente! El software permite la creación de plantillas de tarjetas de acceso, con la máxima calidad y seguridad en los servicios. Desde la tarjeta master, que te permite abrir todas las cerraduras de tu Hotel, hasta la simple limitación de abrir la cerradura por número de usos. El software se puede acceder a través de una computadora en la red, sus funcionalidades están interconectadas, lo que permite saber si el espacio está en uso, en mantenimiento, limpieza o desocupado. También dispone de funciones como programación de eventos, reservas, check-in y check-out, gestión de ocupación, gestión de personal. ;Un software con una interfaz receptiva e intercambio de información en tiempo real!

fr. iTEC OnHospitality est un outil de gestion hôtelière avec une interface moderne, responsive, intuitive et sécurisée pour une gestion simple et efficace! Le logiciel permet la création de modèles de cartes d'accès, avec une qualité et une sécurité maximales dans les services. De la master card, qui permet d'ouvrir toutes les serrures de votre Hôtel, à la simple limitation d'ouverture de la serrure par nombre d'utilisations. Le logiciel est accessible via un ordinateur sur le réseau, ses fonctionnalités sont interconnectées, permettant de savoir si l'espace est utilisé, en maintenance, en nettoyage ou inoccupé. Il a également des fonctions telles que la planification d'événements, les réservations, les enregistrements et les départs, la gestion de l'occupation, la gestion du personnel. Un logiciel avec une interface responsive et un partage d'informations en temps réel!





App | Aplicación | Application

pt. Com a iTEC IoT terá a possibilidade de agilizar as suas comodidades e conexões por intermédio de aparelhos e objetos habilitados a uma ligação permanente à internet. A tecnologia IoT, também conhecida por Internet das Coisas, rege-se por um sistema de dispositivos interconectados que facilitam ao utilizador a execução de diversos tipos de funções desde as mais complexas às mais intuitivas como a recolha, envio e armazenamento de dados ou a otimização de rotinas diárias (limpeza, gestão de custos, ligação a câmeras de controlo/vigilância, etc.). Através da implementação vertiginosa deste sistema em casas particulares, espaços públicos/de lazer e empresas, o futuro de controlo de acesso será mais inteligente.

en. With iTEC IoT you'll be able to streamline your amenities and connections through devices and objects that have a permanent connection to internet. The IoT, also known as Internet of Things, is governed by a system of interconnected devices that facilitate the user perform to multiple types of functions from the most complexity to the most intuitive, such as collecting, sending or storing data or optimizing daily routines (cleaning, cost management, connection to control/surveillance cameras, etc.). Through the faster implementation of this system in private homes, public and leisure spaces and businesses, the future of access control will be smarter.

es. Con iTEC IoT podrá optimizar sus servicios y conexiones a través de dispositivos y objetos que tienen una conexión permanente a Internet. El IoT, también conocido como Internet de las Cosas, se rige por un sistema de dispositivos interconectados que facilitan al usuario realizar múltiples tipos de funciones desde las más complejas hasta las más intuitivas, como recolectar, enviar o almacenar datos u optimizar las rutinas diarias (limpieza, gestión de costes, conexión a cámaras de control / vigilancia, etc.). A través de la implementación más rápida de este sistema en hogares privados, espacios públicos y de ocio y negocios, el futuro del control de acceso será más inteligente.

es. Avec iTEC IoT, vous serez en mesure de rationaliser vos équipements et vos connexions grâce à des appareils et des objets qui ont une connexion permanente à Internet. L'IoT, également connu sous le nom d'Internet des objets, est régi par un système d'appareils interconnectés qui permettent à l'utilisateur d'effectuer plusieurs types de fonctions, des plus complexes aux plus intuitives, telles que la collecte, l'envoi ou le stockage de données ou l'optimisation des routines quotidiennes (nettoyage, gestion des coûts, connexion aux caméras de contrôle/surveillance, etc.). Grâce à la mise en œuvre plus rapide de ce système dans les maisons privées, les espaces publics et de loisirs et les entreprises, l'avenir du contrôle d'accès sera plus intelligent.

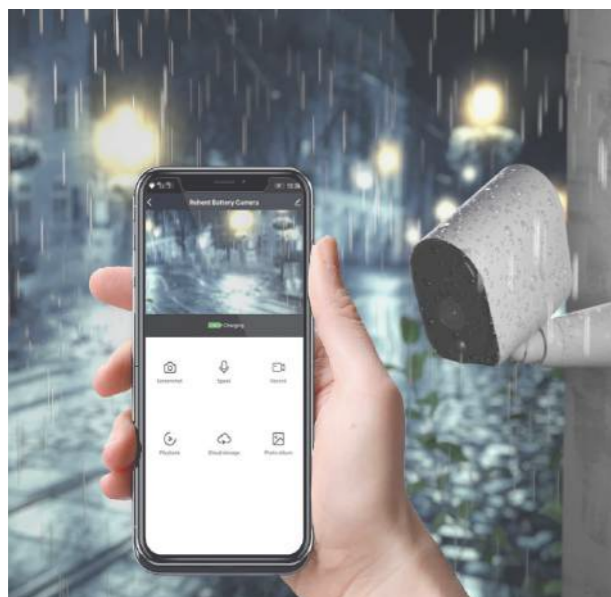

Opções Controlo IoT

iOT Control Options | Opciones de Control de iOT
de iOT | Options de contrôle de l'iOT

Ligar & Desligar
Turn ON & Off

Encender y Apagar
Allume | Éteint

Branco White
Cor Color
Cenário Scene

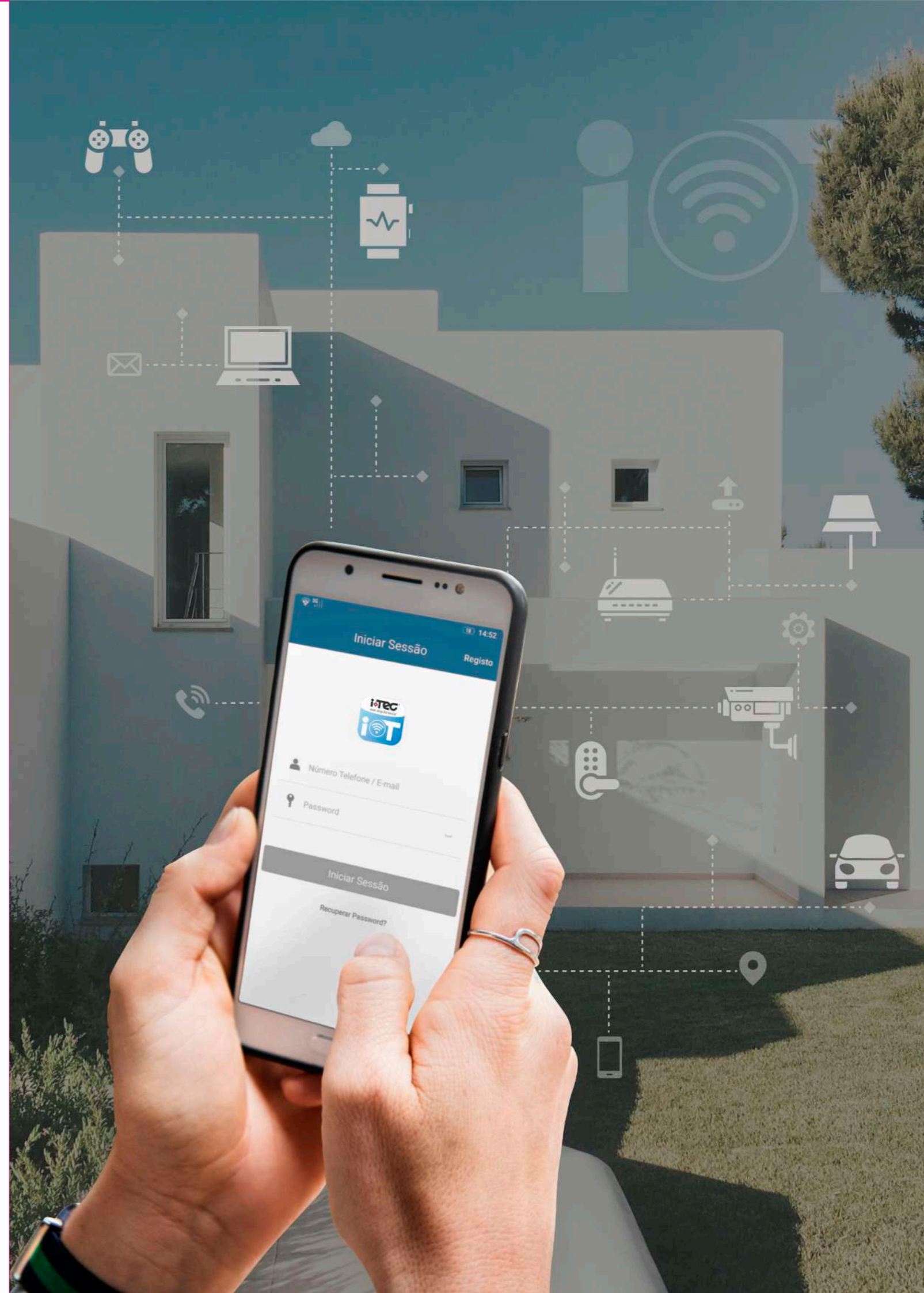



Villa Condo

Solution | Solución | Solution

pt. Utilizando tecnologia de vanguarda a iTEC procura constantemente a máxima precisão para a sua comodidade, neste sentido, destaca-se (e apenas com outra marca mundial do setor da segurança) com a função villa/condo nas suas soluções de controlo de acessos.

en. Using state-of-the-art technology iTEC constantly search for maximum accuracy for your convenience, in this way it stands out (and only with another world-wide brand of the security sector) with the villa / condo function in its access control solutions.

Típico Controlo de Acesso

Typical Access Control | Control de Acceso Típico | Contrôle d'accès typique

pt. Acesso através do terminal de acesso à porta, após fechar a porta, este tranca automaticamente, pode abrir por dentro se houver uma fechadura antipânico.

en. Access through the access terminal, after closing the door, this door automatically locks, you may open from the inside if there is a antipanic lock.

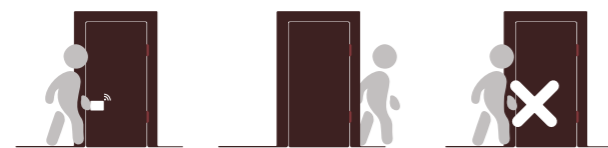

es. Using state-of-the-art technology iTEC constantly search for maximum accuracy for your convenience, in this way it stands out (and only with another world-wide brand of the security sector) with the villa / condo function in its access control solutions.

fr. En utilisant une technologie de pointe, iTEC recherche constamment une précision maximale pour votre confort, de cette façon il se démarque (et seulement avec une autre marque mondiale du secteur de la sécurité) avec la fonction villa / condo dans ses solutions de contrôle d'accès.

es. Access through the access terminal, after closing the door, this door automatically locks, you may open from the inside if there is a antipanic lock.

fr. Accès par le terminal d'accès, après la fermeture de la porte, cette porte se verrouille automatiquement. Vous pouvez ouvrir de l'intérieur si vous avez un verrou anti-panique.

Solução Villa Condo

Villa Condo Solucion | Solución Villa Condo | Villa Condo Solution

pt. Depois de passar o cartão, a fechadura será aberta e permanecerá aberta. Para trancar a fechadura do lado de fora, deve passar o cartão novamente.

en. After passing a card in the lock it will open and remain open. To close the lock from the outside you must pass the card again.

es. Acceso a través de la terminal de acceso de la puerta, después de cerrar la puerta, esta puerta se bloquea automáticamente, puede abrirse desde el interior si hay una cerradura de antipánico.

fr. Accès par le terminal d'accès, après la fermeture de la porte, cette porte se verrouille automatiquement. Vous pouvez ouvrir de l'intérieur si vous avez un verrou anti-panique.











































pt. Para trancar por dentro, deve girar o botão que fecha a trava e o sensor externo tranca.









































en. To lock it from inside you must turn the button that closes the deadbolt and the external sensor locks.

es. Para bloquearlo desde adentro, debe girar el botón que cierra el cerrojo y el sensor externo se bloquea.

fr. Pour le verrouiller de l'intérieur, vous devez tourner le bouton qui ferme le pêne dormant et verrouille le capteur externe.



	Aço inoxidável. Stainless steel. Acero inoxidable. Acier inoxydable.		Automação motorizada. Motorized automation. Automatización motorizada. Automatisation motorisée.
	Plástico ABS. ABS plastic. Plastique ABS		Protocolo Wiegand. Wiegand Protocol. Protocolo Wiegand. Protocole Wiegand.
	Metal. Métal.		Integrável com terminal de controlo de acesso. Integratable with access control terminal. Integrable con terminal de control de acceso. Intégrable avec le terminal de contrôle d'accès.
	Liga de zinco. Zinc alloy. Aleación de zinc. Alliage d'Aluminium.		Pilhas AAA. AAA batteries. Pilas AAA. Piles AAA.
	Liga de Alumínio. Aluminum Alloy. Aleación de Aluminio Alliage de zincs.		Pilhas AA. AA batteries. Pilas AA. Piles AA.
	Vidro. Glass. Cristal. Verre.		Pilhas CR2. CR2 batteries. Pilas CR2. Piles CR2.
	Abertura RFID. RFID Opening. Apertura RFID. Ouverture RFID.		Pilhas CR2032. CR2032 batteries. Pilas CR2032. Piles CR2032.
	Abertura por código. Opening by code. Apertura por código. Ouverture par code.		Pilhas C/LR14. C/LR14 batteries. Pilas C/LR14. Piles C/LR14.
	Abertura por impressão digital. Fingerprint opening. Apertura de huella digital. Ouverture d'empreinte digitale.		Pilhas CR123A. CR123A batteries. Pilas CR123A. Piles CR123A.
	Abertura por toque de três dedos. Opening by touch with three fingers. Toque la apertura de tres dedos. Touchez l'ouverture de trois doigts.		Bateria C36 [3.7V 700mAh 2.59 Wh]. C36 batterie [3.7V 700mAh 2.59 Wh]. Bateria C36 [3.7V 700mAh 2.59 Wh]. Batterie C36 [3.7 V 700mAh 2.59 Wh].
	Abertura por bluetooth. Opening by bluetooth. Apertura por bluetooth. Ouverture par Bluetooth.		Conformance European. Conformance European. Conformidad Europea. Conformité Européenne.
	Abertura por comando. Opening by command. Apertura por comando. Ouverture par commande.		Certificação Underwriters Laboratories. Underwriters Laboratories Certification. Certificación de Underwriters Laboratories. Certification Underwriters Laboratories.
	Leitor de documento de identificação. Identification document reader. Lector de identificación. Lecteur d'identification.		Certificação FCC FCC Certification Certificación FCC Certification FCC
	Abertura por reconhecimento facial. Aperture by facial recognition. Apertura por reconocimiento facial. Ouverture par reconnaissance faciale.		Restrição de Substâncias Perigosas. Restriction of Hazardous Substances. Restricción de Sustancias Peligrosas. Restriction des substances dangereuses.
	Abertura por reconhecimento da palma. Aperture by palm recognition. Apertura por reconocimiento de palma Ouverture par reconnaissance de la paume.		Grau de proteção IP. Degree of IP protection. Grado de protección IP. Degré de protection IP.
	Detecção de uso de máscara. Usage of mask detection. Detección del uso de mascarillas. Détection de l'utilisation du masque.		Funciona em modo Standalone. Works in Standalone mode. Funciona en modo Standalone. Fonctionne en mode Standalone.
	Detecção de temperatura. Temperature detection. Detección de la temperatura. Détection de la température.		Medidas personalizadas por pedido. Custom measures by order. Medidas personalizadas por pedido. Mesures personnalisées sur commande.
	Abertura inteligente por botão. Opening by smart button. Apertura por botón inteligente. Ouverture par bouton intelligent.		Função antipânico. Antipanic function. Función antipánica. Fonction antipanique.
	Abertura por chave de emergência. Aperture by emergency key. Apertura por llave de emergencia. Ouverture par clé d'urgence.		Função não incomodar. Do not disturb function. Función no molestar. Ne pas déranger fonction.
	Interação remota. Remote interaction. Interacción remota. Interaction à distance.		Fecho automático Automatic locking. Cierre automático. Verrouillage automatique.

	Função anti cartão. Anti card function. Función anti tarjeta. Fonction anti carte.		Resistente a incêndio até 3 horas. Fire resistant up to 3 hours. Resistente al fuego hasta 3 horas. Résistant au feu jusqu'à 3 heures.
	Função alarme. Alarm function. Función de alarma. Fonction d'alarme.		Fechadura antipânico de três pontos. Three point antipanic lock. Cerradura antipánico de tres puntos. Serrure anti-panique à trois points.
	Cilindro europeu. European cylinder. Cilindro europeo. Cylindre européen.		Campainha de porta. Door bell. Timbre de la puerta. Porte cloche.
	Norma DIN 18252 (dimensional) DIN 18252 norm [dimensional] Norma DIN 18252 [dimensional]. Norme DIN 18252 [dimension].		Câmera de 2MP. 2MP camera. Cámara de 2MP. Appareil photo 2MP.
	Cilindro perfil redondo. Round profile cylinder Cilindro de perfil redondo. Cylindre à profil rond.		Câmera de 3MP. 3MP camera. Cámara de 3MP. Appareil photo 3MP.
	Palhetão 30° Cam 30° Leva 30° Came 30°		Ecrã de 2.4". 2.4" screen. Pantalla de 2.4". Écran 2.4".
	Cinco pins. Five pins Cinco pines. Cinq goupilles.		Ecrã de 2.6". 2.6" screen. Pantalla de 2.6". Écran 2.6".
	Seis pins. Six pins Seis pines. Six goupilles.		Ecrã de 3.2". 3.2" screen. Pantalla de 3.2". Écran 3.2".
	Duas chaves. Two keys. Dos llaves. Deux clefs.		Ecrã de 4.3". 4.3" screen. Pantalla de 4.3". Écran 4.3".
	Três chaves. Three keys. Tres llaves. Trois clefs.		Comunicação WiFi. WiFi Communication. Comunicación WiFi. Communication WiFi.
	Cinco chaves. Five keys. Cinco llaves. Cinq clefs.		Permite a capturar de imagens. Allows image capture. Permite a captura de imagens. Permet la capture d'image.
	Master key. Chave mestra Llave maestra. Clé maitresse.		Permite a capturar de vídeo. Allows video capture. Permite a captura de vídeo. Permet la capture vidéo.
	Chaves Iguais. Keyed Alike. Llaves iguales. Clés identiques.		Cartão Misco SD (TF). SD (TF) Micro Card. Tarjeta micro SD (TF). Carte micro SD (TF).
	Chaves diferentes. Keys to differ. Llaves diferentes. Clés différentes		Função Infravermelho. Infrared Function. Función de infrarrojos. Fonction infrarouge.
	20.000 combinações de chave [KD]. 20,000 key combinations [KD]. 20,000 combinaciones de llaves [KD]. 20.000 combinaisons de clé [KD].		Bluetooth. Bluetooth. Bluetooth. Bluetooth.
	30.000 combinações de chave [KD]. 30,000 key combinations [KD]. 30,000 combinaciones de llaves [KD]. 30.000 combinaisons de clé [KD].		Entrada Jack 1.5. Jack 1.5 entry. Entrada Jack 1.5. Entrée Jack 1.5.
	Cilindro com função antipânico. Cylinder with antipanic function. Cilindro con función antipánica. Cylindre avec fonction antipanique.		Leitor USB. USB Reader. Lector USB. Lecteur USB.
	Cilindro com função anti perfuração. Cylinder with anti-drill function. Cilindro con función anti perforación. Cylindre avec fonction anti perçage.		Carregador. Charger. Cargador. Chargeur.
	Cilindro com função anti-pick. Cylinder with anti-pick function. Cilindro con función anti-pick. Cylindre avec fonction anti crochetage.		Entrada HDMI. HDMI entry. Entrada HDMI. Entrée HDMI.
	Cilindro com função anti-bump. Cylinder with anti-bump function. Cilindro con función anti-bump. Cylindre avec fonction anti-bumping.		Fonte de alimentação por cabo USB. USB cable power supply. Fuente de alimentación del cable USB. Alimentation par câble USB.

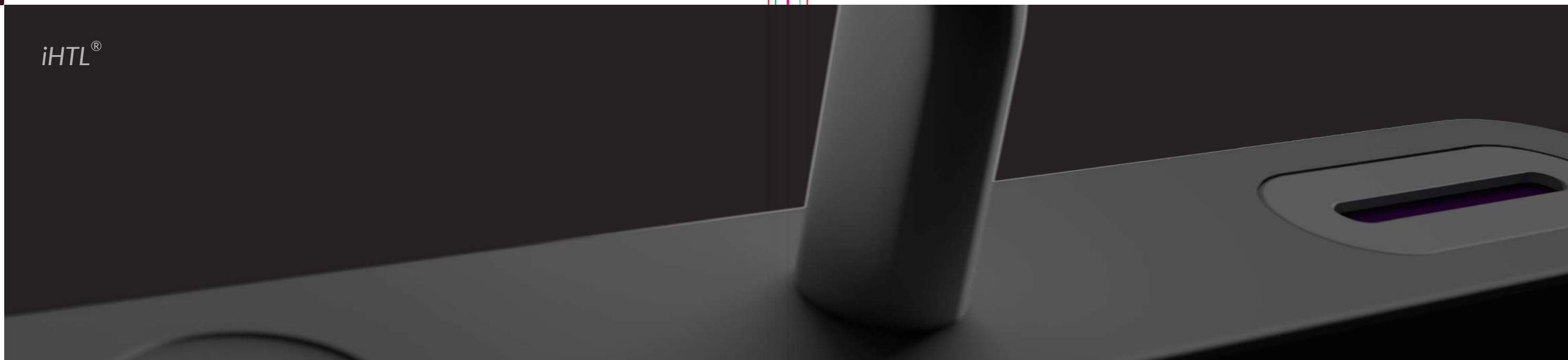

iHTL®



pt. A série iHTL permite todas as operações por proximidade, através de RFID (Mifare) pode configurar todo o acesso através de um software de gestão simples e intuitivo, ou como Standalone com um cartão de gestão.

en. The iHTL series enables all operations by proximity, through RFID (Mifare) you can configure all access through simple and intuitive management software, or as Standalone with a management card.

es. La serie iHTL permite todas las operaciones por proximidad, a través de RFID (Mifare) puede configurar todo el acceso a través de un software de gestión simple e intuitivo, o como Standalone con una tarjeta de gestión.

fr. La série iHTL permet toutes les opérations par proximité. Grâce à la RFID (Mifare), vous pouvez configurer tous les accès via un logiciel de gestion simple et intuitif, ou en mode autonome avec une carte de gestion.

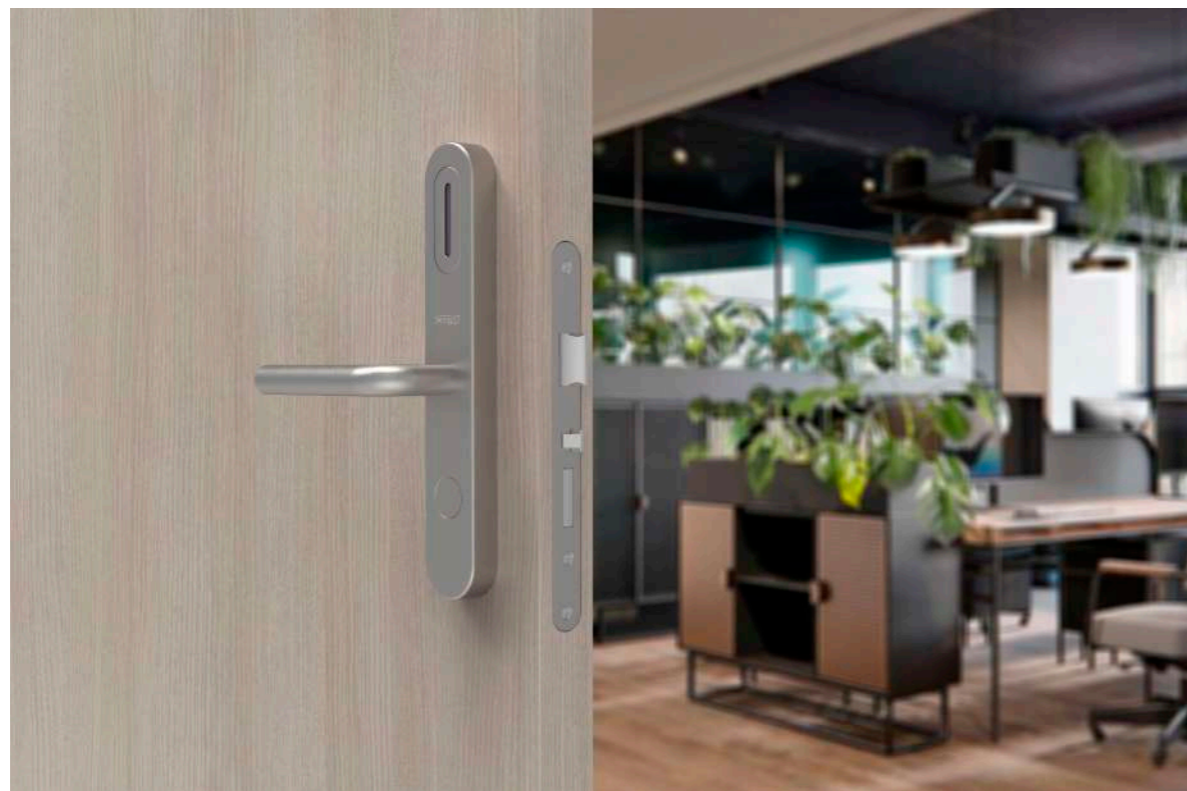

pt. Cores e puxadores disponíveis por pedido
en. Colors and handle available on request

es. Colores y manillas disponibles bajo pedido
fr. Couleurs et poignées disponibles sur demande

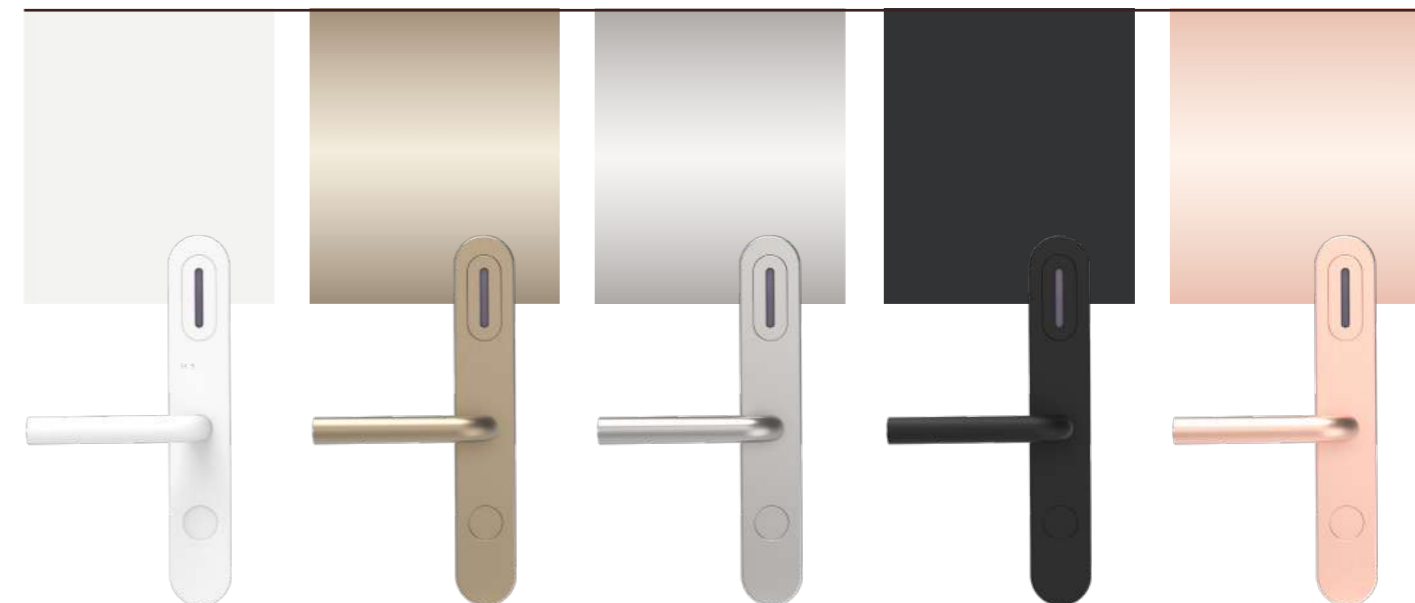
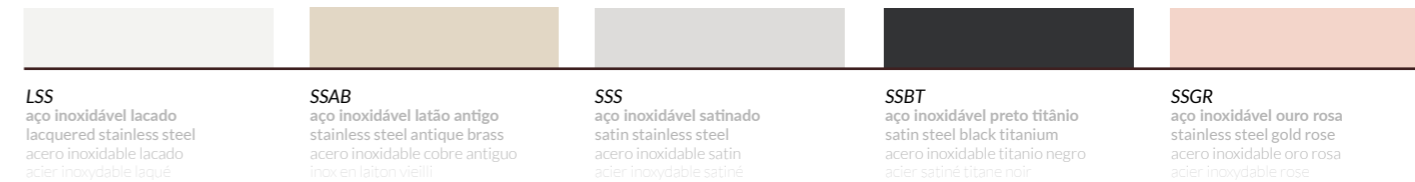
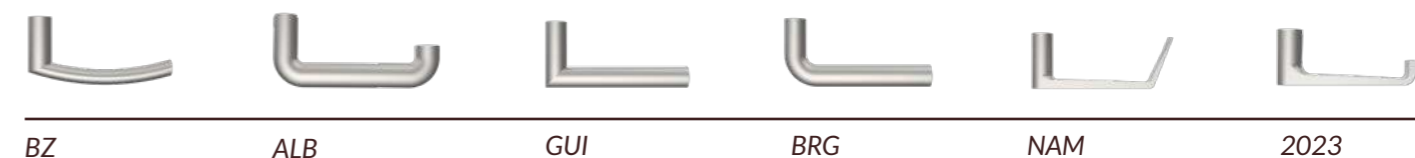

iHTL®

Ficha Técnica

Datasheet

Hoja Técnica

Fiche Technique

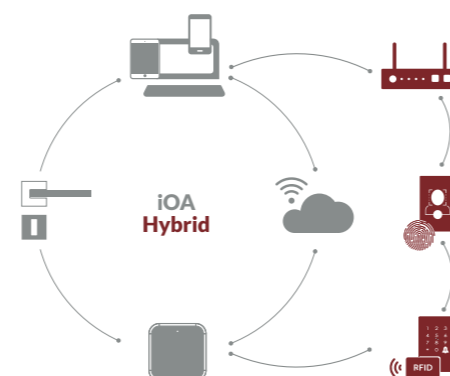

pt.

Material	Aço Inoxidável
Método de Abertura	Cartão, chave mecânica
Tempo de Identificação	<0.1S
Comunicação	Mifare (13,56MHz)
Teclado Toque	Não
Cilindro	Cilindro Europeu
Compatibilidade com fechaduras	Standard Europeu de 70mm a 92mm
Energia de Emergência	N/A
Abertura de Emergência	Chave Mecânica
Potência	DC 6v (AAA*4)
Máx. Potência	6V-MAX
Vida Útil da Bateria	~12 meses

Leds
Alarme de Bateria Fraca

Consumo	<300mA
Consumo Estático	12µA
Tempo Aberto	7 s
Número de Aberturas	~5,000 Aberturas (1Ano)
Software Web	iTEC OnHospitality (Opção) iTEC OnAccessPRO (Opção)

Software Windows	iTEC Hybrid
APP's	iTEC iOA (Opção Integração)
Compatibilidade	N/A
Stand Alone	Sim
IP	IP54
Peso	2,70 Kg
Resistencia à Humidade	30%-95%
Temp. de Funcionamento	-20°C~+ 65°C
Nº de Código via APP	N/A
Nº de Cód. auto-definido	N/A
Nº de Impressão Digital	N/A
Nº do cartões de IC	200
Níveis de Usuários	Sim
Código de Gestão	N/A
Cores Disponíveis	Inox Satin. PVD, outras
Instalação	Residencias, Apartamentos, Residenciais, Escritórios, AIRB-NB, Hotels

Espessura de porta 30mm ~110mm

en.

Material	Stainless steel
Opening Method	Card, Mechanical Key
Identification Time	<0.1S
Communication	Mifare (13,56MHz)
Keypad	No
Cylinder Type	European Cylinder
Compatibility with locks	Standard Europeu de 70mm a 92mm
Emergency Power	N/A
Emergency Opening	Mechanical Key
Voltage	DC 6v (AAA*4)
Max. Power	6V-MAX
Battery Life	~ 12 months

Leds
Low Battery Alarm

Consumption	<300mA
Static Consumption	12µA
Time Open	7 s
Number of Openings	~5,000 Openings (1Year)
Web Software	iTEC OnHospitality (Option) iTEC OnAccessPRO (Option)

Windows Software	iTEC Hybrid
APP's	iTEC iOA (Integration Option)
Compatibility	N/A
Stand Alone	Yes
IP	IP54
Weight	2,70 Kg
Humidity Resistance	30%-95%
Temp. of Operation	-20°C~+ 65°C
Code No. via APP	N/A
Self-defined Code No.	N/A
Fingerprint Number	N/A
IC card number	200
User Levels	Yes
Management Code	N/A
Available Colors	Inox Satin. PVD, other
Installation	Residences, Apartments, Hostels, Offices, AIRBNB, Hotels

Door thickness 30mm ~110mm

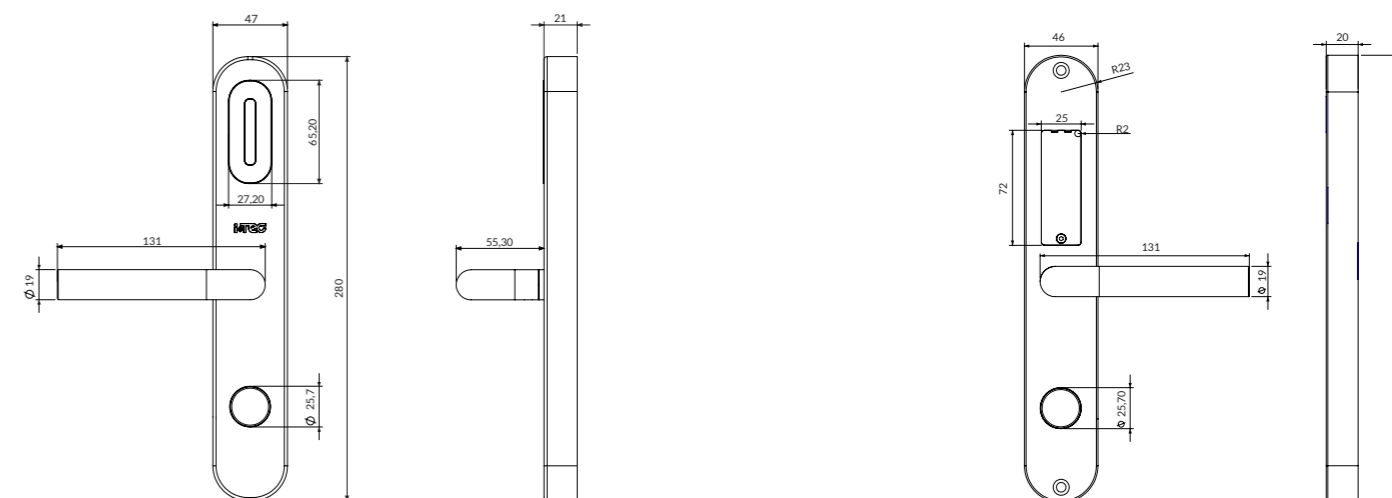

es.

Material	Acero inoxidable
Método de apertura	Tarjeta, llave mecánica
Tiempo de identificación	<0,1S
Comunicación	Mifare (13,56 MHz)
Teclado	No
Bombillo	Bombillo europeo
Tipo de cerraduras	Estándar europeo de 70mm a 92mm
Voltaje	N/A
Apertura de emergencia	Llave mecánica
Duración de la batería	CC 6 V (AAA * 4)
Energía máxima	6V-MAX
Duración de la Bateria	~ 12 meses

Leds
Alarma de batería baja

Consumo	<300 mA
Consumo estático	12µA
Tiempo abierto	7 s
Numero de aperturas	~ 5,000 aperturas (1 año)
Software Web	iTEC OnHospitality (Opción) iTEC OnAccessPRO (Opción)

Software de Windows	iTEC Hybrid
Aplicaciones	iTEC iOA (Opción de Integración)
Compatibilidad	N/A
Stand Alone	Si
IP	IP54
Peso	2,70 kilogramos
Resistencia a la humedad	30% -95%
Temperatura. de operación	-20°C ~ + 65°C
No. de código via APP	N/A
No. Código autodefinido	N/A
Número de huella digital	N/A
Número de tarjeta IC	200
Niveles de usuario	Si
Código de gestión	N/A
Colores disponibles	Inox Satin. PVD, otro
Instalación	Residencias, Apartamentos, Hostales, Oficinas, AIRBNB, Hoteles

Espesor de puerta 30 mm ~ 110 mm

fr.

Matériel	Acier inoxydable
Méthode d'ouverture	Carte, clé mécanique
Temps d'identification	<0,1 S
Communication	N/A
Clavier	Mifare (13,56 MHz)
Compatibilité avec les serrures	Non
Ouverture d'urgence	Cylindre européen
Alimentation de secours	Eur Standard de 70 mm à 92 mm
Max. Puissance	N/A
Vie de la batterie	Clé mécanique
Max. Puissance	DC 6 v (AAA * 4)
Vie de la batterie	6V-MAX
Vie de la batterie	~ 12 mois
Vie de la batterie	Admite ~ 5,000 operaciones de apertura y cierre
Vie de la batterie	Prend en charge environ 5000 opérations d'ouverture

Leds
Alarme de batterie faible

Consumption	<300 mA
Consumation	12µA
Temps ouvert	7 s
Nombre d'ouvertures	~ 5000 ouvertures (1 an)
Logiciel Web	iTEC OnHospitality (Option) iTEC OnAccessPRO (Option)

Logiciel Windows	iTEC Hybrid
Applications	iTEC iOA (Possibilité d'intégration)
Compatibilité	N/A
Autonome	Oui
IP	IP54
Poids	2,70 kilogrammes
Résistance à l'humidité	30% -95%
Temp. De fonctionnement	-20 ° C à + 65 ° C
N ° de code via APP	N/A
N ° de code auto-défini	N/A
Numéro digitale	N/A
Numéro de carte IC	200
Niveaux d'utilisateurs	Oui
Code de gestion	N/A
Couleurs disponibles	Inox Satin. PVD, autre
Installation	Residences, appartements, auberges, bureaux, AIRBNB, hôtels

Épaisseur de la porte 30 mm ~ 110 mm

iHTL 03®

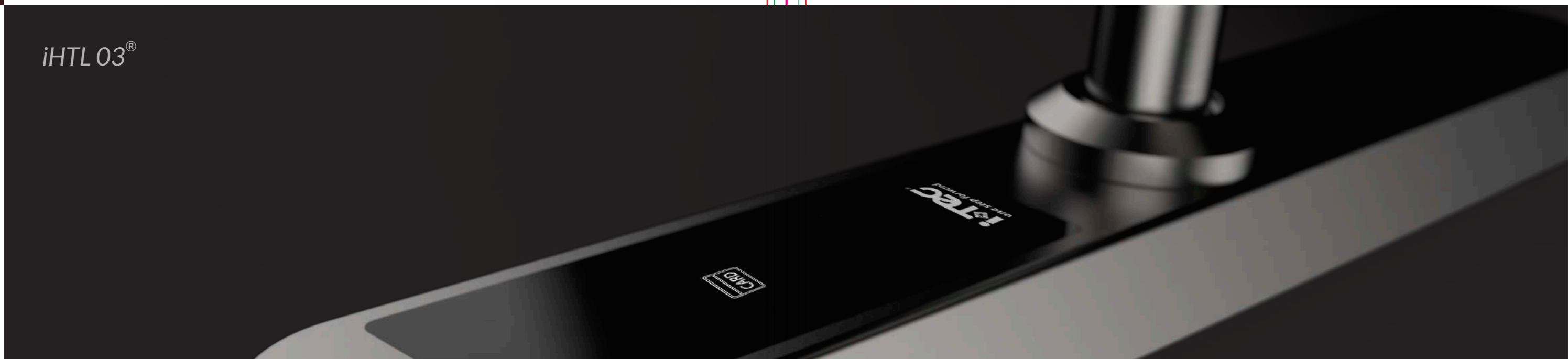

pt. A iHTL 03 traz um novo visual à simplicidade do processo de abertura por cartão RFID (Mifare), com um design mais fino e elegante, oferece também uma nova função, a iHTL 03® é compatível com o aplicativo iTEC OnAccess/iTEC OnAccess Pro/iTEC Hybrid/ OnHospitality, trazendo todas as suas vantagens.

en. The iHTL 03 brings a new look to the simplicity of the RFID card (Mifare) opening process, with a slimmer and sleek design, it also offers a new function, the iHTL 03® is compatible with the iTEC OnAccess/iTEC OnAccess Pro/iTEC Hybrid/ OnHospitality, bringing all its advantages.

es. El iHTL 03 aporta una nueva apariencia a la simplicidad del proceso de apertura de la tarjeta RFID (Mifare), con un diseño más delgado y elegante, también ofrece una nueva función, el iHTL 03® es compatible con la aplicación iTEC OnAccess/iTEC OnAccess Pro/iTEC Hybrid/ OnHospitality, brindando todas sus ventajas.

fr. Le iHTL 03 apporte un nouveau regard sur la simplicité du processus d'ouverture de la carte RFID (Mifare), avec un design plus fin et élégant, il offre également une nouvelle fonction, l'iHTL 03® est compatible avec l'application iTEC OnAccess/iTEC OnAccess Pro/iTEC Hybrid/ OnHospitality, apportant tous ses avantages.

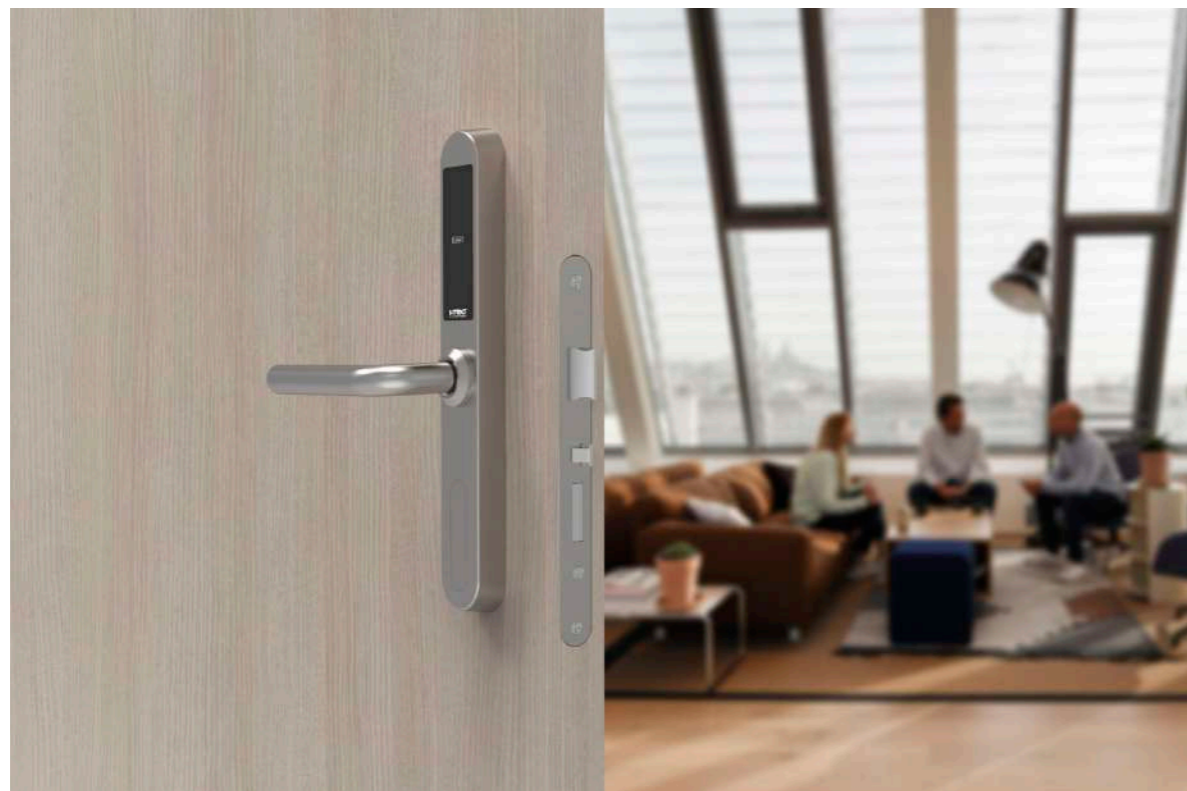

pt. Cores e puxadores disponíveis por pedido
en. Colors and handle available on request

es. Colores y manillas disponibles bajo pedido
fr. Couleurs et poignées disponibles sur demande

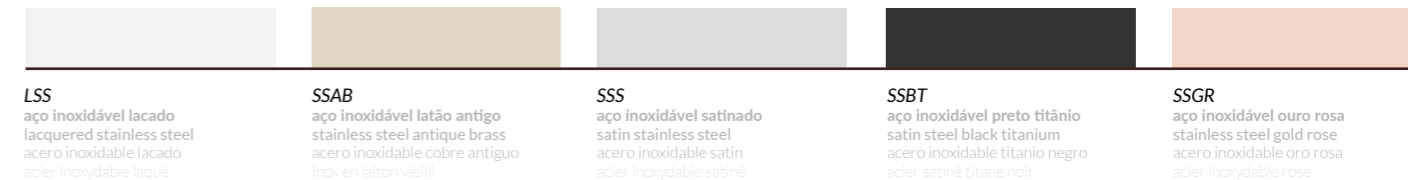

LSS
aço inoxidável lacado
lacquered stainless steel
acero inoxidable lacado
acier inoxydable laqué

SSAB
aço inoxidável latão antigo
stainless steel antique brass
acero inoxidable cobre antiguo
inox en laiton vieilli

SSS
aço inoxidável satinado
satin stainless steel
acero inoxidable satin
acier inoxydable satiné

SSBT
aço inoxidável preto titânio
satin steel black titanium
acero inoxidable titânio negro
acier satiné titane noir

SSGR
aço inoxidável ouro rosa
stainless steel gold rose
acero inoxidable oro rosa
acier inoxydable rose

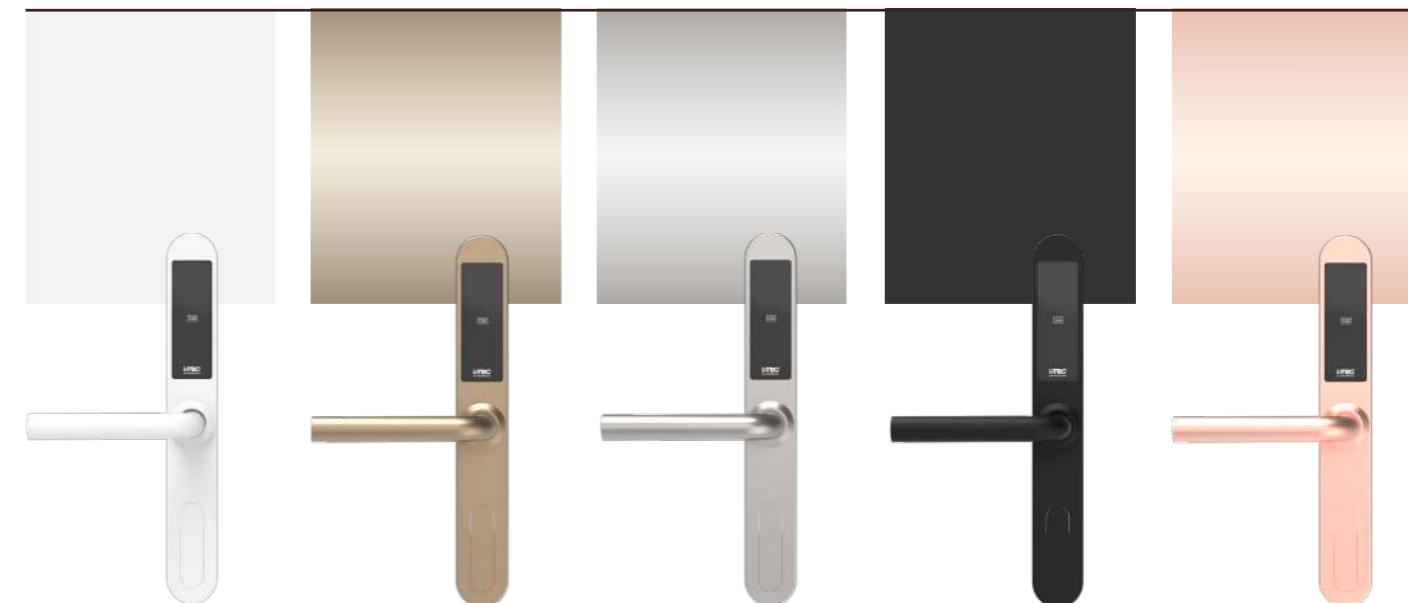

iHTL 03[®]**Ficha Técnica**

Datasheet

Hoja Técnica

Fiche Technique

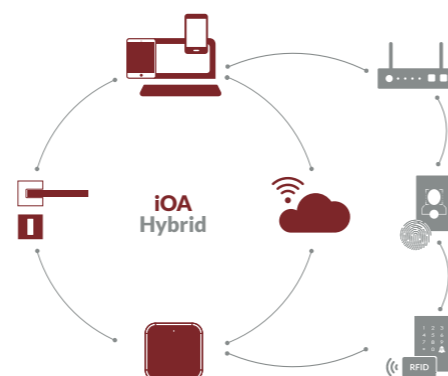

pt.		en.	
Material	Aço Inoxidável	Material	Stainless steel
Método de Abertura	Cartão, Wifi, BLE, APP, Chave Mecânica	Opening Method	Card, Wifi, BLE, APP, Mechanical Key <0.1S
Tempo de Indentificação	<0.1S	Identification Time	Bluetooth 4.1
Comunicação	Bluetooth 4.1; Mifare(13,56MHz)	Communication	Mifare (13,56MHz)
Teclado Toque	Não	Keypad	No
Cilindro	Cilindro Europeu	Cylinder Type	European Cylinder
Compatibilidade com fechaduras	Standard Europeu de 70mm a 92mm	Compatibility with locks	European standard from 70mm to 92mm
Energia de Emergência	Micro USB	Emergency Power	Micro USB
Abertura de Emergência	Chave Mecânica	Emergency Opening	Mechanical Key
Potência	DC 6v (AAA*4)	Voltage	DC 6v (AAA*4)
Máx. Potência	6V-MAX	Max. Power	6V-MAX
Vida Útil da Bateria	~12 meses	Battery Life	~ 12 months
	Suporta ~ 5,000 Operações de Abertura & Fecho		Supports ~ 5,000 Opening & Closing Operations
Leds	Branco	Leds	White
Alarme de Bateria Fraca	Na APP e Alarme por voz	Low Battery Alarm	In the APP and Voice Alarm
Consumo	<200mA		Below 4,8V
Consumo Estático	65µA	Consumption	<200mA
Tempo Aberto	5s; 10s; 15S; 30s; 60s; personalizado	Static Consumption	65µA
Número de Aberturas	~5,000 Aberturas (1Año)	Time Open	9s; 10s; 15S; 30s; 60s; custom
Software Web	iTEC OnHospitality iTEC OnAccessPRO	Number of Openings	~5,000 Openings (1Year)
	iTEC Hybrid	Web software	iTEC OnHospitality iTEC OnAccessPRO
Software Windows	iTEC Hybrid	Windows software	iTEC Hybrid
APP's	ITEC iOA (Opção Integração)	APP's	ITEC iOA (Integration Option)
Compatibilidade	IOS 8 e superior Android 5 e superior	Compatability	IOS 8 or earlier; Android 5 or earlier
Stand Alone	N/A	Stand Alone	N/A
IP	IP56	IP	IP56
Peso	1,86 Kg	Weight	1,86 Kg
Resistência à Humidade	30%-95%	Humidity Resistance	30%-95%
Temp. de Funcionamento	-20°C~+55°C	Temp. of Operation	-20°C~+55°C
Nº de Código via APP	N/A	Code No. via APP	N/A
Nº de Cód. auto-definido	N/A	Self-defined Code No.	N/A
Nº de Impressão Digital	N/A	Fingerprint Number	N/A
Nº do cartões de IC	200	IC card number	200
Níveis de Usuários	Sim	User Levels	Yes
Código de Gestão	Sim	Management Code	Yes
Cores Disponíveis	Aço Inox Satinado	Available Colors	Satin Stainless Steel
Instalação	Residencias, Apartamentos, Escritórios, AIRBNB, Hotéis	Installation	Residences, Apartments, Hostels, Offices, AIRBNB, Hotels
Espessura de porta	30mm~110mm	Door thickness	30mm~110mm

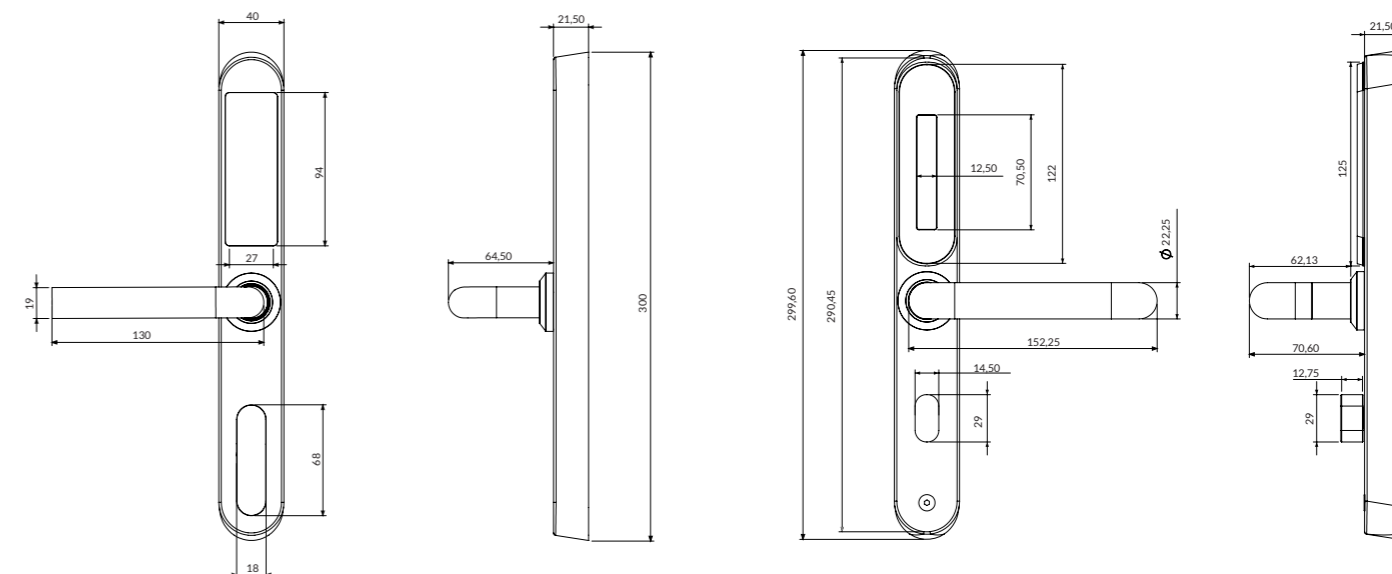

es.		fr.	
Material	Acero inoxidable	Matériel	Acier inoxydable
Método de apertura	Tarjeta, Wifi, BLE, APLICACIÓN, Llave mecánica	Méthode d'ouverture	Carte, Wifi, BLE, APP, Clé mécanique <0.1S
Tiempo de identificación	<0,1 S	Temps d'identification	Bluetooth 4.1
Comunicación	Bluetooth 4.1; Mifare (13,56 MHz)	Communication	Mifare (13,56 MHz)
Teclado	No	Clavier	Non
Bombillo	Bombillo europeo	Cylinder	Cylinder européenne
Tipo de cerraduras	Estándar europeo de 70 mm a 92 mm	Compatibilité avec les serrures	Norme européenne 70mm à 92mm
Voltaje	Micro USB	Ouverture d'urgence	Clé à molette
Apertura de emergencia	Llave mecánica	Alimentation de secours	CC 6V (AAA * 4)
Duración de la batería	CC 6 V (AAA * 4)	Max. Puissance	6V-MAX
Energia máxima	6V-MAX	Vie de la batterie	~ 12 mois
Duración de la Bateria	~ 12 meses	Max. Puissance	Prend en charge ~ 5 000 opérations d'ouverture et de fermeture
	Admite ~ 5,000 operaciones de apertura y cierre	Vie de la batterie	Blanc
Leds	Blanco	Leds	Dans l'application et alarme vocale
Alarma de batería baja	En la aplicación y alarma por voz	Alarme de batterie faible	En dessous de 4,8V
	Por debajo de 4,8 V	Consommation statique	<200 mA
Consumo	<200 mA	Consommation	65µA
Consumo estático	65µA	Temps ouvert	5s ; 10 s ; 15 s ; 30 s ; années 60 : personnalisé
Tiempo Aberto	5s; 10s; 15s; 30s; 60s; personalizado	Nombre d'ouvertures	~ 5000 ouvertures (1 an)
Numero de aperturas	~ 5,000 aperturas (1 año)	Logiciel Web	iTEC OnHospitality iTEC OnAccessPRO
Software de Web	iTEC OnHospitality iTEC OnAccessPRO	Logiciel Windows	iTEC Hybrid
Software de Windows	iTEC Hybrid	Applications	iTEC iOA (Possibilité d'intégration)
APP's	ITEC iOA (Opción de Integración)	Compatibilité	IOS 8, Android 5 ou supérieur
Compatibilidad	IOS 8, Android 5 o superior;	Autonome	N/A
Stand Alone	N/A	Poids	1,86 kg
IP	IP56	Résistance à l'humidité	30% -95%
Peso	1,86 kilogramos	Temp. De fonctionnement	-20°C ~ + 55°C
Resistencia a la humedad	30% -95%	N ° de code via APP	N/A
Temperatura. de operación	-20°C ~ + 55°C	N ° de code auto-défini	N/A
No. de código vía APP	N/A	Numéro d'empreinte digitale	N/A
No. Código autodefinido	N/A	Numéro de carte IC	200
Número de huella digital	N/A	Niveaux d'utilisateurs	Oui
Número de tarjeta IC	200	Code de gestion	Oui
Niveles de usuario	Sí	Couleurs disponibles	Acier inoxydable satiné
Código de gestión	Sí	Installation	Résidences, Appartements, Auberges, Bureaux, AIRBNB, Hôtels
Colores disponibles	Acero inoxidable satinado	Épaisseur de la porte	30 mm ~ 110 mm
Instalación	Residencias, Apartamentos, Hostales, Oficinas, AIRBNB, Hoteles		
Espeor de puerta	30 mm ~ 110 mm		

iHTL cUL[®]



pt. Reconhecida pela sua confiabilidade, robustez e alta tecnologia. Com esta solução, o processo de abertura é feita por dispositivos de proximidade RFID (Mifare). Totalmente sem fio e com baixo consumo de energia. Você também pode configurar todos os acessos por meio do nosso software.

en. Recognized for its reliability, robustn and high technologic. With this solution, the opening process is by RFID (Mifare) proximity devices. Totally wire free and with low energy consumption. You can also setup all access through our software.

es. Reconocida por su garantía, solidez y su alta tecnología. Con esta solución, el proceso de Apertura de estos dispositivos estaran mas proximos de RFID (Mifare). Totalmente sin cables y con bajo consumo de energía. Puede configurar todo el acceso a través de nuestro software.

fr. Reconnu pour sa fiabilité, sa robustesse et sa haute technologie. Avec cette solution, le processus d'ouverture se fait par des dispositifs de proximité RFID (Mifare). Totalemnt sans fil et avec une faible consommation d'énergie. Vous pouvez également configurer tous les accès via notre logiciel.



pt. Cores e puxadores disponíveis por pedido
en. Colors and handle available on request

es. Colores y manillas disponibles bajo pedido
fr. Couleurs et poignées disponibles sur demande



BZ



ALB



GUI



BRG



NAM



2023

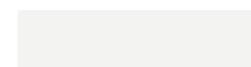

LSS
aço inoxidável lacado
lacquered stainless steel
acero inoxidable lacado
acier inoxydable laqué



SSAB
aço inoxidável latão antigo
stainless steel antique brass
acero inoxidable cobre antiguo
inox en laiton vieilli



SSS
aço inoxidável satinado
satin stainless steel
acero inoxidable satin
acier inoxydable satiné



SSBT
aço inoxidável preto titânio
satin steel black titanium
acero inoxidable titanio negro
acier satiné titane noir



SSGR
aço inoxidável ouro rosa
stainless steel gold rose
acero inoxidable oro rosa
acier inoxydable rose

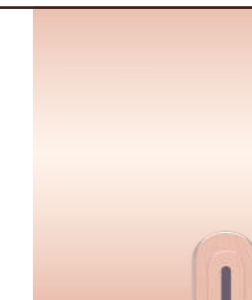
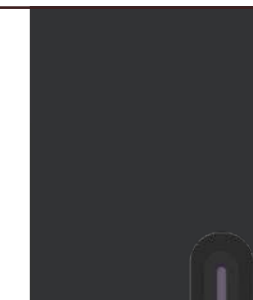
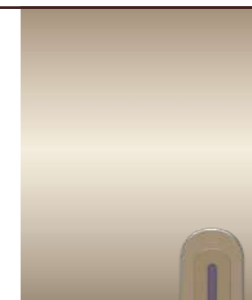
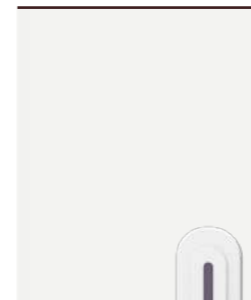

iHTL cUL®

Ficha Técnica

Datasheet

Hoja Técnica

Fiche Technique

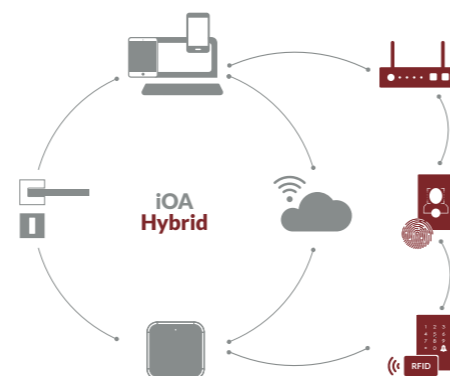

pt.

Material	Aço Inoxidável
Método de Abertura	Cartão, chave mecânica <0.1S
Tempo de Identificação	N/A
Comunicação	Mifare (13,56MHz)
Teclado Toque	Não
Cilindro	Meio cilindro Redondo ANSI
Compatibilidade com fechaduras	Fechadura ANSI
Energia de Emergência	N/A
Abertura de Emergência	Chave Mecânica
Potência	DC 6v (AAA*4)
Máx. Potência	6V-MAX
Vida Útil da Bateria	~12 meses Suporta ~ 5,000 Operações
Leds	Verde e Vermelho
Alarme de Bateria Fraca	3 bips; Abaixo de 4,8V
Consumo	<300mA
Consumo Estático	12µA
Tempo Aberto	7 s
Número de Aberturas	5,000 Aberturas (1Ano)
Software Web	iTEC OnHospitality iTEC OnAccessPRO
Software Windows	iTEC Hybrid
APP's	iTEC iOA (Opção Integração)
Compatibilidade	N/A
Stand Alone	Sim
IP	IP54
Peso	2,70 Kg
Resistencia à Humidade	30%-95%
Temp. de Funcionamento	-20°C~+ 65°C
Nº de Código via APP	N/A
Nº de Cód. auto-definido	N/A
Nº de Impressão Digital	N/A
Nº do cartões de IC	200
Níveis de Usuários	Sim
Código de Gestão	N/A
Cores Disponíveis	Inox Satin. PVD, outras
Instalação	Residências, Apartamentos, Residenciais, Escritórios, AIRBNB, Hotéis
Espessura de porta	38mm ~110mm

en.

Material	Stainless steel
Opening Method	Card, Mechanical Key
Identification Time	<0.1S
Communication	Mifare (13,56MHz)
Keypad	No
Cylinder Type	ANSI Round half cylinder
Compatibility with locks	Ansi Lock
Emergency Power	N/A
Emergency Opening	Mechanical Key
Voltage	DC 6v (AAA*4)
Max. Power	6V-MAX
Battery Life	~ 12 months Supports ~ 5,000 Opening & Closing Operations
Leds	Green, red
Low Battery Alarm	3 bips Below 4,8V
Consumption	<300mA
Static Consumption	12µA
Time Open	7 s
Number of Openings	~5,000 Openings (1Year)
Web Software	iTEC OnHospitality iTEC OnAccessPRO
Windows Software	iTEC Hybrid
APP's	iTEC iOA (Integration Option)
Compatibility	N/A
Stand Alone	Yes
IP	IP54
Weight	2,70 Kg
Humidity Resistance	30%-95%
Temp. of Operation	-20°C~+ 65°C
Code No. via APP	N/A
Self-defined Code No.	N/A
Fingerprint Number	N/A
IC card number	200
User Levels	Yes
Management Code	N/A
Available Colors	Inox Satin. PVD, other
Installation	Residences, Apartments, Hostels, Offices, AIRBNB, Hotels
Door thickness	38mm ~110mm

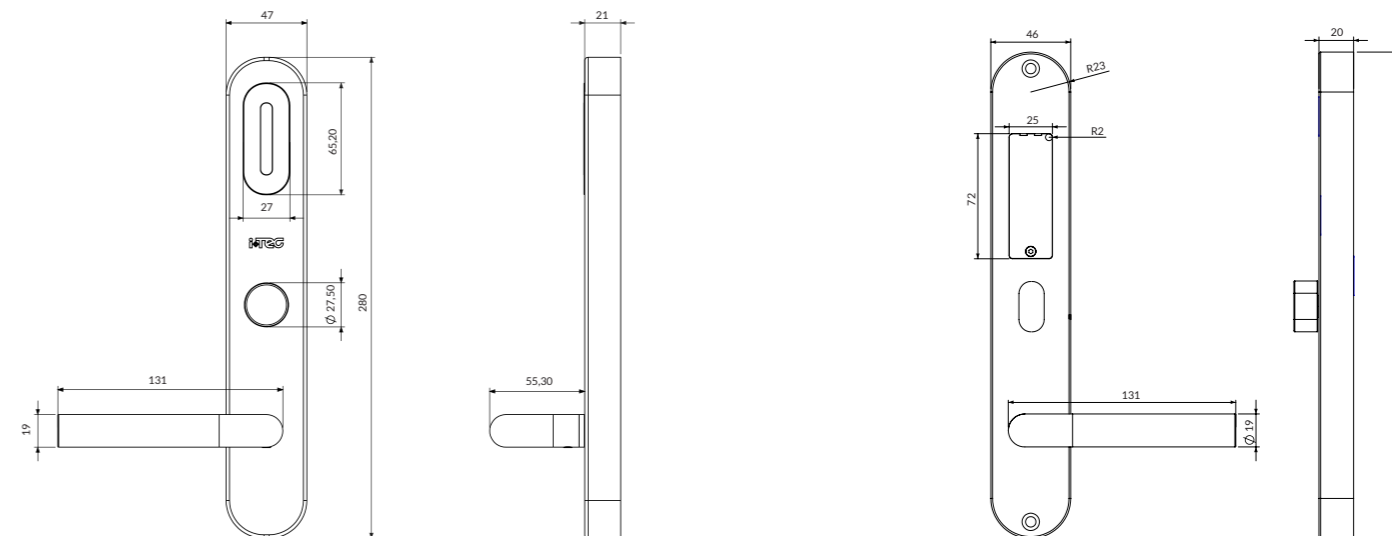

es.

Material	Acero inoxidable
Método de apertura	Tarjeta, llave mecánica
Tiempo de identificación	<0,1 S
Comunicación	Mifare (13,56 MHz)
Teclado	No
Bombillo	Medio cilindro redondo ANSI
Tipo de cerraduras	Cerradura Ansi
Voltaje	N/A
Apertura de emergencia	Llave mecánica
Duración de la batería	CC 6 V (AAA * 4)
Energía máxima	6V-MAX
Duración de la Bateria	~ 12 meses Admite ~ 5,000 operaciones de apertura y cierre
Leds	Verde, Rojo
Alarma de batería baja	3 picos Por debajo de 4,8 V
Consumo	<300 mA
Consumo estático	12µA
Tiempo Aberto	7 s
Numero de aperturas	~ 5,000 aperturas (1 año)
Softwate Web	iTEC OnHospitality iTEC OnAccessPRO
Software de Windows	iTEC Hybrid
Aplicaciones	iTEC iOA (Opción de Integración)
Compatibilidad	N/A
Stand Alone	Sí
IP	IP54
Peso	2,70 kilogramos
Resistencia a la humedad	30% -95%
Temperatura. de operación	-20°C ~ + 65°C
No. de código via APP	N/A
No. Código autodefinido	N/A
Número de huella digital	N/A
Número de tarjeta IC	200
Niveles de usuario	Sí
Código de gestión	N/A
Colores disponibles	Inox Satin. PVD, otro
Instalación	Residencias, Apartamentos, Hosta- les, Oficinas, AIRBNB, Hoteles
Espesor de puerta	38 mm ~ 110 mm

fr.

Matériel	Acier inoxydable
Méthode d'ouverture	Carte, clé mécanique
Temps d'identification	<0,1 S
Communication	Mifare (13,56 MHz)
Clavier	Non
Cylindre	Demi-cylindre rond ANSI
Compatibilité avec les serrures	Ansi Lock
Puissance	N/A
Ouverture d'urgence	Clé mécanique
Alimentation de secours	DC 6 v (AAA * 4)
Max. Puissance	6V-MAX
Vie de la batterie	~ 12 mois Prend en charge environ 5000 opéra- tions d'ouverture et de fermeture
Leds	Vert rouge
Alarme de batterie faible	3 bips En dessous de 4,8V
Consommation statique	<300 mA
Consommation	12µA
Temps ouvert	7 s
Nombre d'ouvertures	~ 5000 ouvertures (1 an)
Logiciel Web	iTEC OnHospitality iTEC OnAccessPRO
Logiciel Windows	iTEC Hybrid
Applications	iTEC iOA (Possibilité d'intégration)
Compatibilité	N/A
Autonome	Oui
IP	IP54
Poids	2,70 kilogrammes
Résistance à l'humidité	30% -95%
Temp. De fonctionnement	-20 °C à + 65 °C
N ° de code via APP	N/A
N ° de code auto-défini	N/A
Numéro d'empreinte digitale	N/A
Numéro de carte IC	200
Niveaux d'utilisateurs	Oui
Code de gestion	N/A
Couleurs disponibles	Inox Satin. PVD, autre
Installation	Résidences, appartements, auberges, bureaux, AIRBNB, hôtels
Épaisseur de la porte	38 mm à 110 mm

iHTL L cUL[®]



pt. Reconhecida pela sua forma alargada e robusta. À semelhança da solução anterior, o processo de abertura é por dispositivos de proximidade RFID (Mifare). Totalmente wireless e com baixo consumo de energia. Você também pode configurar todos os acessos por meio de nosso software.

en. Recognized for its enlarged and robust shape. Like the previous solution, in this solution, the opening process is by RFID proximity devices (Mifare). Totally wireless and with low power consumption. You can also configure all access through our software.

es. Reconocido por su forma alargada y robusta. Al igual que la solución anterior, en esta solución el proceso de apertura es mediante dispositivos de proximidad RFID (Mifare). Totalmente inalámbrico y con bajo consumo de energía. También puede configurar todos los accesos a través de nuestro software.

fr. Reconnu pour sa forme élargie et robuste. Comme la solution précédente, dans cette solution, le processus d'ouverture se fait par des dispositifs de proximité RFID (Mifare). Totalement sans fil et avec une faible consommation d'énergie. Vous pouvez également configurer tous les accès via notre logiciel.



pt. Cores e puxadores disponíveis por pedido
en. Colors and handle available on request

es. Colores y manillas disponibles bajo pedido
fr. Couleurs et poignées disponibles sur demande

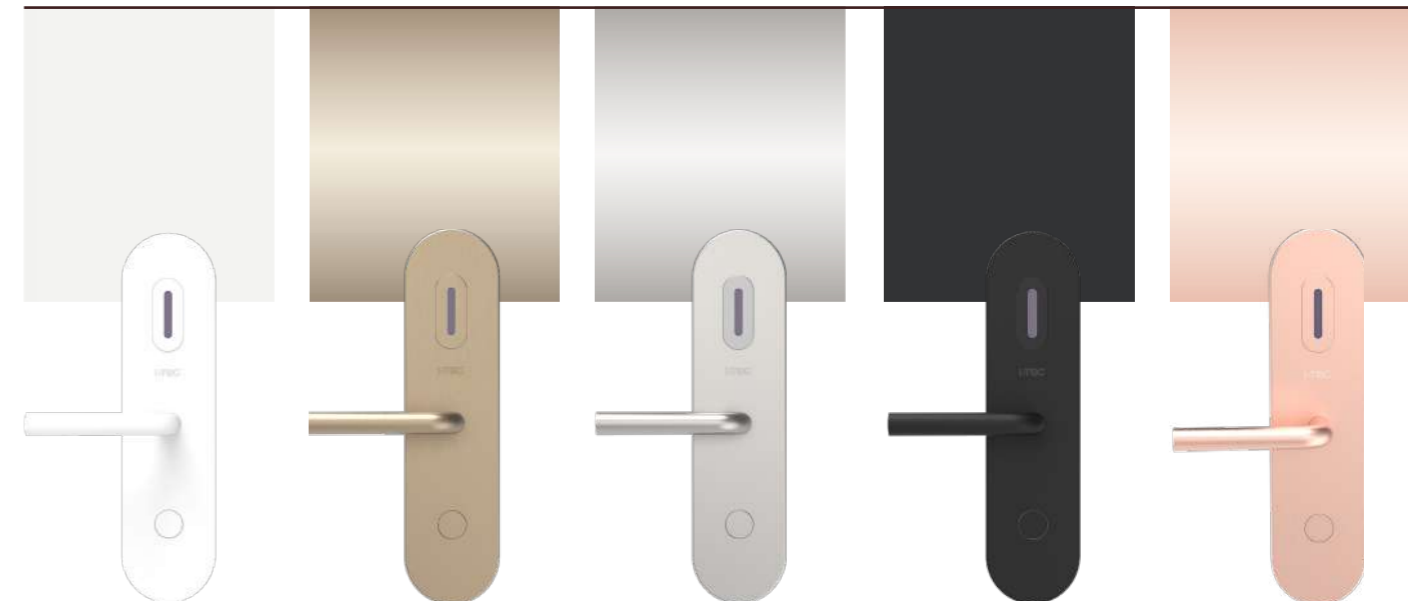

iHTL L cUL®

Ficha Técnica

Datasheet

Hoja Técnica

Fiche Technique

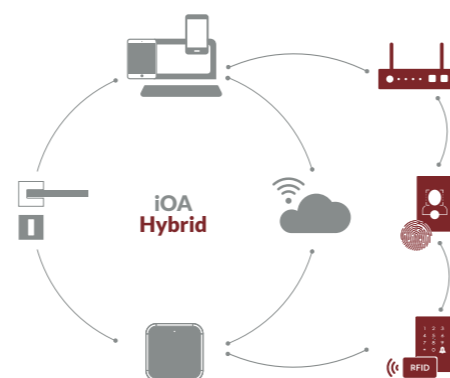

pt.

Material	Aço Inoxidável
Método de Abertura	Cartão, chave mecânica
Tempo de Identificação	<0.1S
Comunicação	Mifare (13,56MHz)
Teclado Toque	Não
Cilindro	Meio cilindro Redondo ANSI
Compatibilidade com fechaduras	Fechadura ANSI
Energia de Emergência	N/A
Abertura de Emergência	Chave Mecânica
Potência	DC 6v (AAA*4)
Máx. Potência	6V-MAX
Vida Útil da Bateria	~12 meses

Leds	Verde e Vermelho
Alarme de Bateria Fraca	3 bips; Abaixo de 4,8V
Consumo	<300mA
Consumo Estático	12µA
Tempo Aberto	7 s
Número de Aberturas	5,000 Aberturas (1Ano)
Software Web	iTEC OnHospitality iTEC OnAccessPRO

Software Windows	iTEC Hybrid
APP's	iTEC iOA (Opção Integração)
Compatibilidade	N/A
Stand Alone	Sim
IP	IP54
Peso	3,20 Kg
Resistencia à Humidade	30%-95%
Temp. de Funcionamento	-20°C~+ 65°C
Nº de Código via APP	N/A
Nº de Cód. auto-definido	N/A
Nº de Impressão Digital	N/A
Nº do cartões de IC	200
Níveis de Usuários	Sim
Código de Gestão	N/A
Cores Disponíveis	Inox Satin. PVD, outras
Instalação	Apartamentos, Residenciais, Escritórios, AIRBNB, Hotéis

Espessura de porta

38mm ~110mm

en.

Material	Stainless steel
Opening Method	Card, Mechanical Key
Identification Time	<0.1S
Communication	Mifare (13,56MHz)
Keypad	No
Cylinder Type	ANSI Round half cylinder
Compatibility with locks	ANSI Lock
Emergency Power	N/A
Emergency Opening	Mechanical Key
Voltage	DC 6v (AAA*4)
Max. Power	6V-MAX
Battery Life	~ 12 months

Leds	Green, red
Low Battery Alarm	3 bips Below 4,8V
Consumption	<300mA
Static Consumption	12µA
Time Open	7 s
Number of Openings	~5,000 Openings (1Year)
Web Software	iTEC OnHospitality iTEC OnAccessPRO

Windows Software	iTEC Hybrid
APP's	iTEC iOA (Integration Option)
Compatibility	N/A
Stand Alone	Yes
IP	IP54
Weight	3,20 Kg
Humidity Resistance	30%-95%
Temp. of Operation	-20°C~+ 65°C
Code No. via APP	N/A
Self-defined Code No.	N/A
Fingerprint Number	N/A
IC card number	200
User Levels	Yes
Management Code	N/A
Available Colors	Inox Satin. PVD, other
Installation	Residences, Apartments, Hostels, Offices, AIRBNB, Hotels
Door thickness	38mm ~110mm

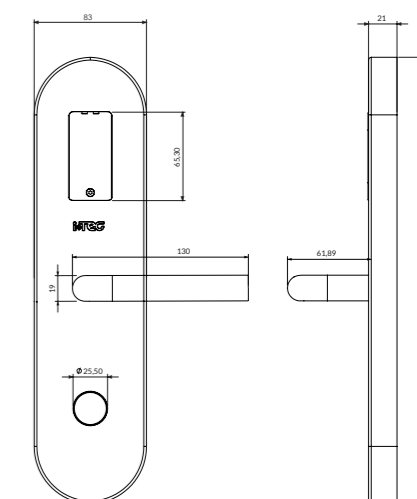
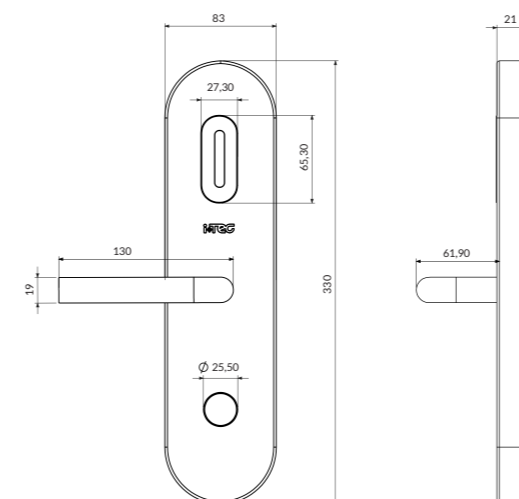

es.

Material	Acero inoxidable
Método de apertura	Tarjeta, llave mecánica
Tiempo de identificación	<0,1 S
Comunicación	Mifare (13,56 MHz)
Teclado	No
Bombillo	Medio cilindro redondo ANSI
Tipo de cerraduras	Cerradura Ansi
Voltaje	N/A
Apertura de emergencia	Llave mecánica
Duración de la batería	CC 6 V (AAA * 4)
Energía máxima	6V-MAX
Duración de la Bateria	~ 12 meses

Leds	Verde, Rojo
Alarma de batería baja	3 picos Por debajo de 4,8 V
Consumo	<300 mA
Consumo estático	12µA
Tiempo Aberto	7 s
Número de aperturas	~ 5,000 aperturas (1 año)
Software Web	iTEC OnHospitality iTEC OnAccessPRO

Software de Windows	iTEC Hybrid
Aplicaciones	iTEC iOA (Opción de Integración)
Compatibilidad	N/A
Stand Alone	Sí
IP	IP54
Peso	3,20 kilogramos
Resistencia a la humedad	30% -95%
Temperatura. de operación	-20°C ~ + 65°C
No. de código via APP	N/A
No. Código autodefinido	N/A
Número de huella digital	N/A
Número de tarjeta IC	200
Niveles de usuario	Sí
Código de gestión	N/A
Colores disponibles	Inox Satin. PVD, otro
Instalación	Residencias, Apartamentos, Hostales, Oficinas, AIRBNB, Hoteles
Espesor de puerta	38 mm ~ 110 mm

fr.

Matériel	Acier inoxydable
Méthode d'ouverture	Carte, clé mécanique
Temps d'identification	<0,1 S
Communication	Mifare (13,56 MHz)
Clavier	Non
Cylindre	Demi-cylindre rond ANSI
Compatibilité avec les serrures	ANSI Lock
Puissance	N / A
Ouverture d'urgence	Clé mécanique
Alimentation de secours	DC 6 v (AAA * 4)
Max. Puissance	6V-MAX
Vie de la batterie	~ 12 mois
Vie de la batterie	Prend en charge environ 5000 opérations d'ouverture et de fermeture

Leds	Vert rouge
Alarme de batterie faible	3 bips En dessous de 4,8V
Consommation statique	<300 mA
Consommation	12µA
Temps ouvert	7 s
Nombre d'ouvertures	~ 5000 ouvertures (1 an)
Logiciel Web	iTEC OnHospitality iTEC OnAccessPRO
Logiciel Windows	iTEC Hybrid
Applications	iTEC iOA (Possibilité d'intégration)
Compatibilité	N/A
Autonome	Oui
IP	IP54
Poids	3,20 kilogrammes
Résistance à l'humidité	30% -95%
Temp. De fonctionnement	-20 °C à + 65 °C
N ° de code via APP	N/A
N ° de code auto-défini	N/A
Numéro d'empreinte digitale	N/A
Numéro de carte IC	200
Niveaux d'utilisateurs	Oui
Code de gestion	N/A
Couleurs disponibles	Inox Satin. PVD, autre
Installation	Résidences, appartements, auberges, bureaux, AIRBNB, hôtels
Épaisseur de la porte	38 mm à 110 mm

iCode 03[®]

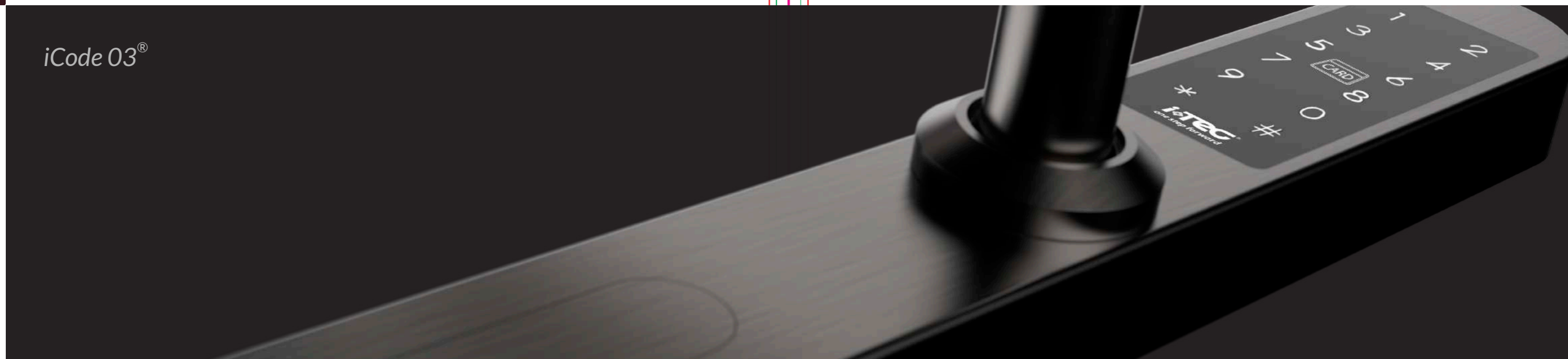

pt. A iCode 03 é o modelo mais recente da linha iCode, inclui os recursos da sua versão anterior como a abertura por código PIN, permitindo ainda a abertura por RFID.

en. The iCode 03 is the latest model in the iCode line, including features from its previous version such as PIN code opening, while also allowing RFID opening.

es. El iCode 03 es el último modelo de la línea iCode. Incluye características de su versión anterior, como la apertura del código PIN, a la vez que permite la apertura de RFID.

fr. Le dernier modèle de la gamme iCode, l'iCode 03 comprend des fonctionnalités de la version précédente, telles que l'ouverture du code PIN, tout en permettant l'ouverture de RFID.



pt. Cores e puxadores disponíveis por pedido
en. Colors and handle available on request

es. Colores y manillas disponibles bajo pedido
fr. Couleurs et poignées disponibles sur demande

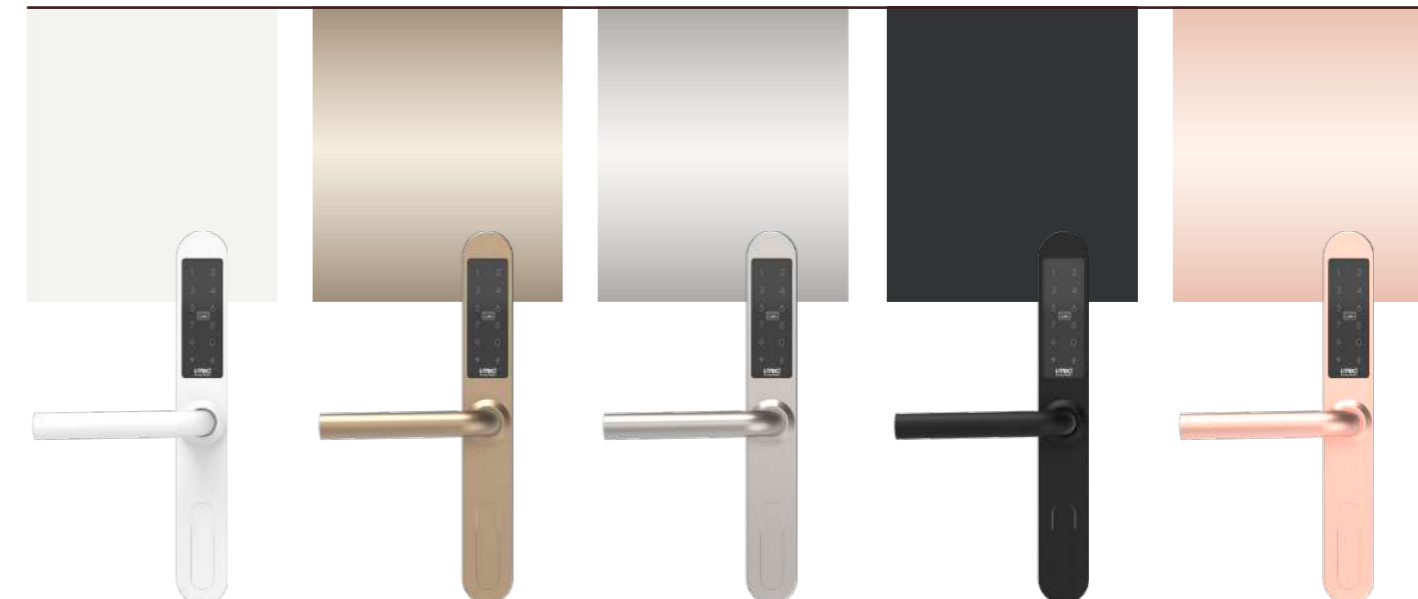
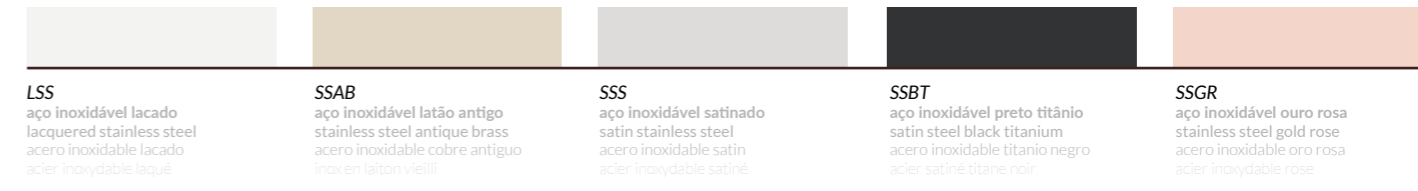

iCode 03[®]

Ficha Técnica

Datasheet

Hoja Técnica

Fiche Technique

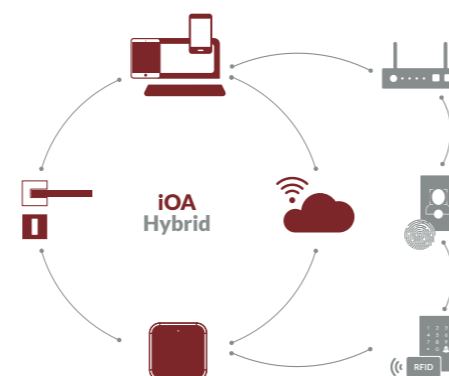

pt.		en.	
Material	Aço Inoxidável	Material	Stainless steel
Método de Abertura	Código , Cartão, Wifi, BLE, APP, Chave Mecânica	Opening Method	Code, Card, Wifi, BLE, APP, Mechanical Key
Tempo de Identificação	<0.1S	Identification Time	<0.1S
Comunicação	Bluetooth 4.1; Mifare (13,56MHz)	Communication	Bluetooth 4.1; Mifare (13,56MHz)
Teclado Toque	Sim	Keypad	Yes
Cilindro	Cilindro Europeu	Cylinder Type	European Cylinder
Compatibilidade com fechaduras	Standard Europeu de 70mm a 92mm	Compatibility with locks	European standard from 70mm to 92mm
Energia de Emergência	Micro USB	Emergency Power	Micro USB
Abertura de Emergência	Chave Mecânica	Emergency Opening	Mechanical Key
Potência	DC 6v (AAA*4)	Voltage	DC 6v (AAA*4)
Máx. Potência	6V-MAX	Max. Power	6V-MAX
Vida Útil da Bateria	~12 meses	Battery Life	~ 12 months
	Suporta ~ 5,000 Operações de Abertura & Fecho		Supports ~ 5,000 Opening & Closing Operations
Leds	Branco	Leds	White
Alarme de Bateria Fraca	Na APP e Alarme por voz	Low Battery Alarm	In the APP and Voice Alarm
Consumo	<200mA	Consumption	<200mA
Consumo Estático	65µA	Static Consumption	65µA
Tempo Aberto	5s; 10s; 15S; 30s; 60s; personalizado	Time Open	8s; 10s; 15S; 30s; 60s; custom
Número de Aberturas	~5,000 Aberturas (1Ano)	Number of Openings	~5,000 Openings (1Year)
Software Web	iTEC OnHospitality iTEC OnAccessPRO	Web Software	iTEC OnHospitality iTEC OnAccessPRO
Software Windows	iTEC Hybrid	Windows Software	iTEC Hybrid
APP's	iTEC iOA	APP's	iTEC iOA
Compatibilidade Stand Alone	IOS 8; Android 5; e superiores.	Compatibility Stand Alone	IOS 8 or earlier; Android 5 or earlier
IP	Sim	Stand Alone	Yes
Peso	IP56	IP	IP56
Resistencia à Humidade	1,92 Kg	Weight	1,92 Kg
Temp. de Funcionamento	30%-95%	Humidity Resistance	30% -95%
Nº de Código via APP	-20°C~+55°C	Temp. of Operation	-20°C~+55°C
Nº de Cód. auto-definido	Ilimitado	Code No. via APP	Unlimited
Nº de Impressão Digital	150	Self-defined Code No.	150
Nº do cartões de IC	N/A	Fingerprint Number	N/A
Níveis de Usuários	200	IC card number	200
Código de Gestão	Sim	User Levels	Yes
Cores Disponíveis	Sim	Management Code	Yes
Instalação	Aço Inox Satinado	Available Colors	Satin Stainless Steel
	Residências, Apartamentos, Residenciais, Escritórios, AIRBNB, Hotéis	Installation	Residences, Apartments, Hostels, Offices, AIRBNB, Hotels
Espessura de porta	30mm~110mm	Door thickness	30mm~110mm

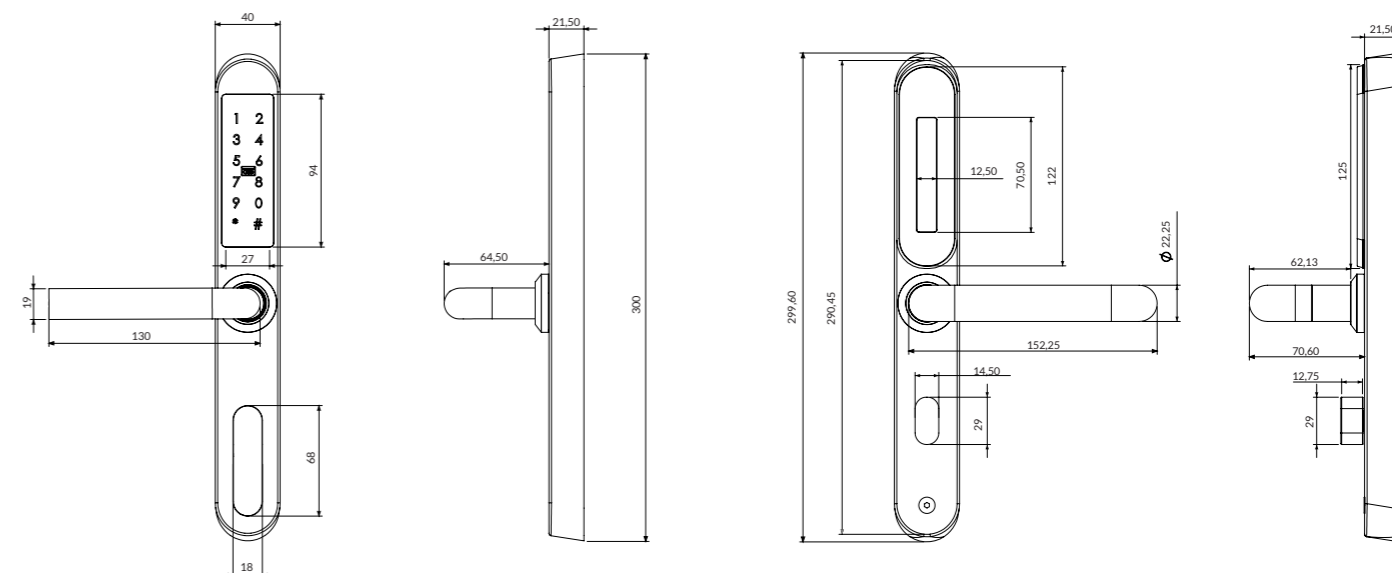

es.		fr.	
Matériel	Acero inoxidable	Matériel	Acier inoxydable
Métode d'ouverture	Código, Tarjeta, Wifi, BLE, APLICACIÓN, Llave mecánica	Métode d'ouverture	Code, carte, Wifi, BLE, APP, clé mécanique
Temps d'identification	<0,1 S	Temps d'identification	<0,1 S
Communication	Bluetooth 4.1; Mifare (13,56 MHz)	Communication	Bluetooth 4.1; Mifare (13,56 MHz)
Clavier	Si	Clavier	Oui
Bombillo	Bombillo europeo	Cylindre	Cylindre européen
Compatibilité avec les serrures	Estándar europeo de 70 mm a 92 mm	Compatibilité avec les serrures	Norme européenne de 70 mm à 92 mm
Ouverture d'urgence	Micro USB	Ouverture d'urgence	Micro USB
Alimentation de secours	Llave mecánica	Alimentation de secours	Clé mécanique
Max. Puissance	CC 6 V (AAA * 4)	Max. Puissance	DC 6 v (AAA * 4)
Vie de la batterie	6V-MAX	Vie de la batterie	6V-MAX
Vie de la batterie	~ 12 meses	Vie de la batterie	~ 12 mois
	Admite ~ 5,000 operaciones de apertura y cierre		Prend en charge environ 5000 opérations d'ouverture et de fermeture
Leds	Blanco	Leds	Blanc
Alarme de batería faible	En la aplicación y alarma por voz	Alarme de batterie faible	Dans l'application et l'alarme vocale
Consumption statique	<200 mA	Consumption statique	En dessous de 4,8V
Consumption	65µA	Consumption statique	<200 mA
Temps ouvert	5s; 10s; 15s; 30s; 60s; personalizado	Consumption	65µA
Numero de aberturas	~ 5,000 aberturas (1 año)	Temps ouvert	8s; 10s; 15S; 30s; 60s; Douane
Software Web	iTEC OnHospitality iTEC OnAccessPRO	Nombre d'ouvertures	~ 5000 ouvertures (1 an)
	iTEC OnAccessPRO	Logiciel Web	iTEC OnHospitality iTEC OnAccessPRO
Software de Windows	iTEC Hybrid	Logiciel Windows	iTEC Hybrid
Aplicaciones	iTEC iOA	Applications	iTEC iOA
Compatibilidad	IOS 8 ; Android 5; o superior	Compatibilité	IOS 8; Android 5; ou supérieur
Autonome	Si	Autonome	Oui
IP	IP56	IP	IP56
Poids	1,92 kilogramos	Poids	1,92 kilogrammes
Résistance à l'humidité	30% -95%	Résistance à l'humidité	30% -95%
Temp. De fonctionnement	-20°C ~ + 55°C	Temp. De fonctionnement	-20 ° C à + 55 ° C
Nº de code via APP	Ilimitado	Nº de code via APP	Illimité
Nº de code auto-défini	150	Nº de code auto-défini	150
Numéro d'empreinte digitale	N/A	Numéro d'empreinte digitale	N/A
Numéro de carte IC	200	Numéro de carte IC	200
Niveaux d'utilisateurs	Si	Niveaux d'utilisateurs	Oui
Code de gestion	Si	Code de gestion	Oui
Couleurs disponibles	Acero inoxidable satinado	Couleurs disponibles	Acier inoxydable satiné
Installation	Residencias, Apartamentos, Hostales, Oficinas, AIRBNB, Hoteles	Installation	Residences, appartements, auberges, bureaux, AIRBNB, hôtels
Épaisseur de la porte	30 mm ~ 110 mm	Épaisseur de la porte	30mm~110mm

iCode 03 cUL[®]

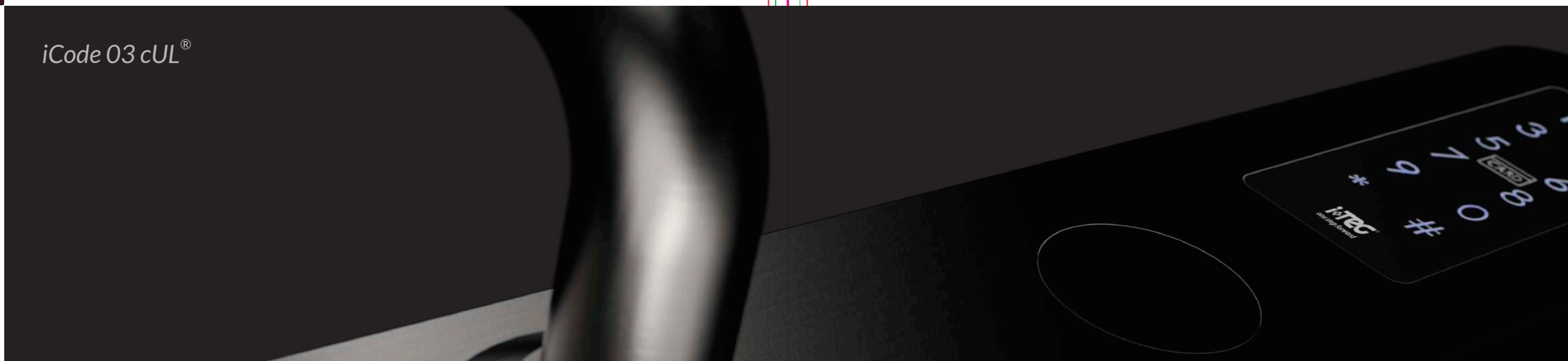

pt. A iCode 03 cUL possui um design exclusivo e robusto com cantos arredondados suaves. Esta fechadura eletrónica inclui recursos como abertura por código PIN, RFID, BLE, Wifi ou abertura por chave mecânica onde você pode configurar e gerir todos os recursos através de um APP ou do nosso software.

en. The iCode 03 cUL has a unique design and robust design, shaped with soft rounded corners, this electronic handle includes features such as PIN code opening, RFID, BLE, Wifi or mechanical key opening. Where you can configure and manage all features through an APP or our software.

es. El iCode 03 cUL tiene un diseño único y diseño robusto, con forma de suaves esquinas redondeadas, este mango electrónico incluye características como apertura de código PIN, RFID, BLE, Wifi o apertura de llave mecánica. Donde puede configurar y administrar todas las funciones a través de una Aplicación o nuestro software.

fr. L'iCode 03 cUL a un design unique et un design robuste, formé avec des coins arrondis doux, cette poignée électronique comprend des fonctionnalités telles que l'ouverture par code PIN, RFID, BLE, Wifi ou l'ouverture par clé mécanique. Où vous pouvez configurer et gérer toutes les fonctionnalités via une application ou notre logiciel.



pt. Cores e puxadores disponíveis por pedido
en. Colors and handle available on request

es. Colores y manillas disponibles bajo pedido
fr. Couleurs et poignées disponibles sur demande

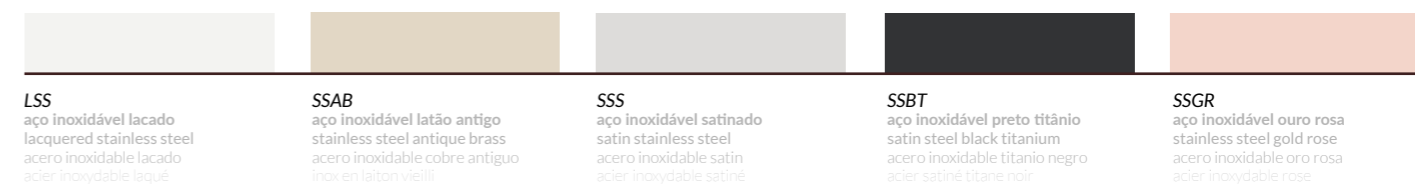
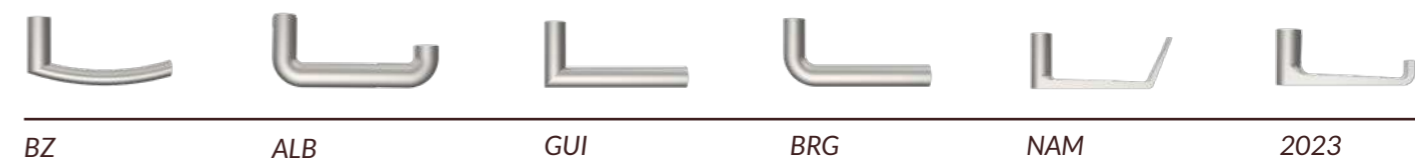

LSS
aço inoxidável lacado
lacquered stainless steel
acero inoxidable lacado
acier inoxydable laqué

SSAB
aço inoxidável latão antigo
stainless steel antique brass
acero inoxidable cobre antiguo
inox en laiton vieilli

SSS
aço inoxidável satinado
satin stainless steel
acero inoxidable satin
acier inoxydable satiné

SSBT
aço inoxidável preto titânio
satin steel black titanium
acero inoxidable titânio negro
acier satiné titane noir

SSGR
aço inoxidável ouro rosa
stainless steel gold rose
acero inoxidable oro rosa
acier inoxydable rose

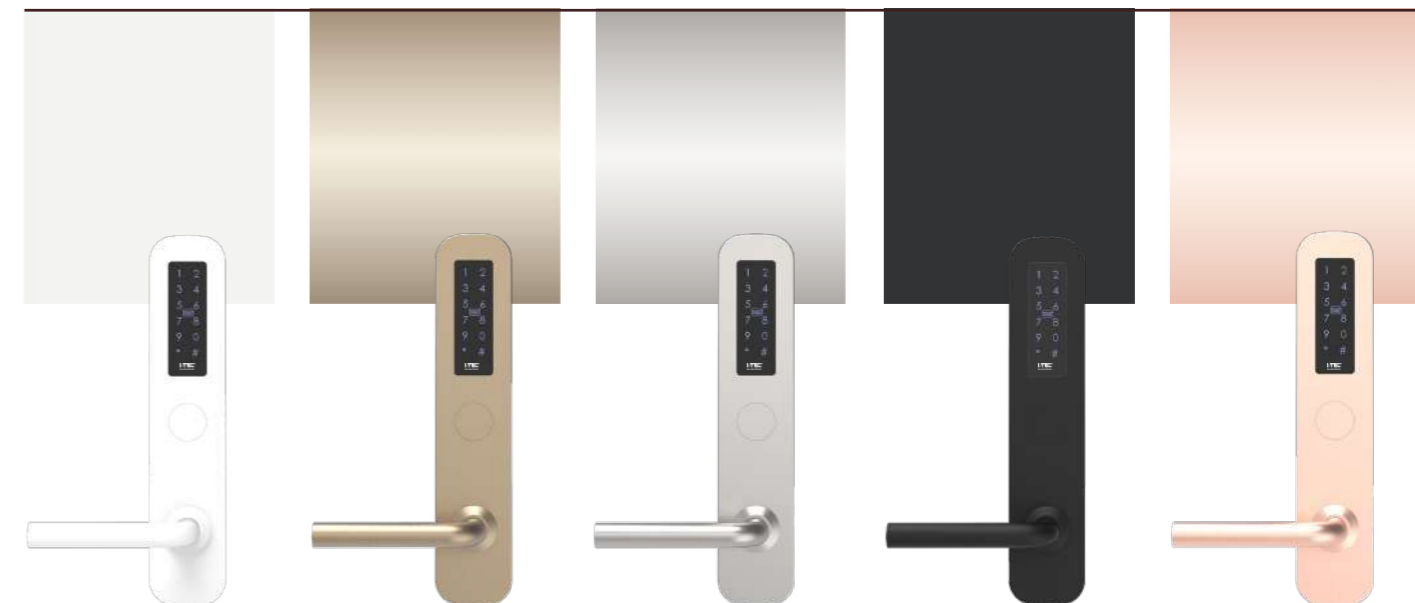

iCode 03 cUL[®]

Ficha Técnica

Datasheet

Hoja Técnica

Fiche Technique

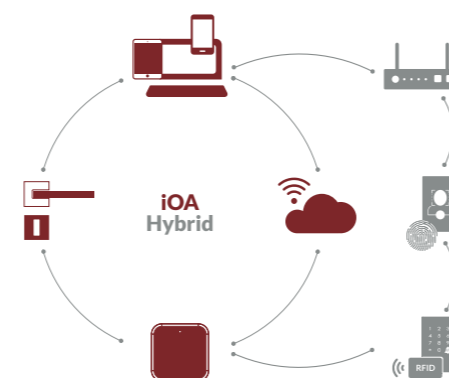

pt.		en.	
Material	Aço Inoxidável	Material	Stainless steel
Método de Abertura	Código , Cartão, Wifi, BLE, APP, Chave Mecânica	Opening Method	Code, Card, Wifi, BLE, APP, Mechanical Key
Tempo de Identificação	<0.1S	Identification Time	<0.1S
Comunicação	Bluetooth 4.1; Mifare (13,56MHz)	Communication	Bluetooth 4.1; Mifare (13,56MHz)
Teclado Toque	Sim	Keypad	Yes
Cilindro	Cilindro ANSI	Cylinder Type	ANSI Cylinder
Compatibilidade com fechaduras	70mm a 92mm	Compatibility with locks	From 70mm to 92mm
Energia de Emergência	Micro USB	Emergency Power	Micro USB
Abertura de Emergência	Chave Mecânica	Emergency Opening	Mechanical Key
Potência	DC 6v (AAA*4)	Voltage	DC 6v (AAA*4)
Máx. Potência	6V-MAX	Max. Power	6V-MAX
Vida Útil da Bateria	~12 meses	Battery Life	~ 12 months
	Suporta ~ 5,000 Operações de Abertura & Fecho		Supports ~ 5,000 Opening & Closing Operations
Leds	Branco	Leds	White
Alarme de Bateria Fraca	Na APP e Alarme por voz	Low Battery Alarm	In the APP and Voice Alarm
Consumo	<200mA	Consumption	<200mA
Consumo Estático	65µA	Static Consumption	65µA
Tempo Aberto	5s; 10s; 15S; 30s; 60s; personalizado	Time Open	8s; 10s; 15S; 30s; 60s; custom
Número de Aberturas	~5,000 Aberturas (1Ano)	Number of Openings	~5,000 Openings (1Year)
Software Web	iTEC OnHospitality iTEC OnAccessPRO	Web Software	iTEC OnHospitality iTEC OnAccessPRO
Software Windows	iTEC Hybrid	Windows Software	iTEC Hybrid
APP's	iTEC iOA	APP's	iTEC iOA
Compatibilidade Stand Alone	IOS 8; Android 5; e superiores.	Compatibility Stand Alone	IOS 8 or earlier; Android 5 or earlier
IP	IP56	IP	IP56
Peso	1,92 Kg	Weight	1,92 Kg
Resistencia à Humidade	30%-95%	Humidity Resistance	30% -95%
Temp. de Funcionamento	-20°C~+55°C	Temp. of Operation	-20°C~+55°C
Nº de Código via APP	Ilimitado	Code No. via APP	Unlimited
Nº de Cód. auto-definido	150	Self-defined Code No.	150
Nº de Impressão Digital	N/A	Fingerprint Number	N/A
Nº do cartões de IC	200	IC card number	200
Níveis de Usuários	Sim	User Levels	Yes
Código de Gestão	Sim	Management Code	Yes
Cores Disponíveis	Aço Inox Satinado	Available Colors	Satin Stainless Steel
Instalação	Residências, Apartamentos, Residenciais, Escritórios, AIRBNB, Hotéis	Installation	Residences, Apartments, Hostels, Offices, AIRBNB, Hotels
		Door thickness	30mm~110mm
Espessura de porta	30mm~110mm		

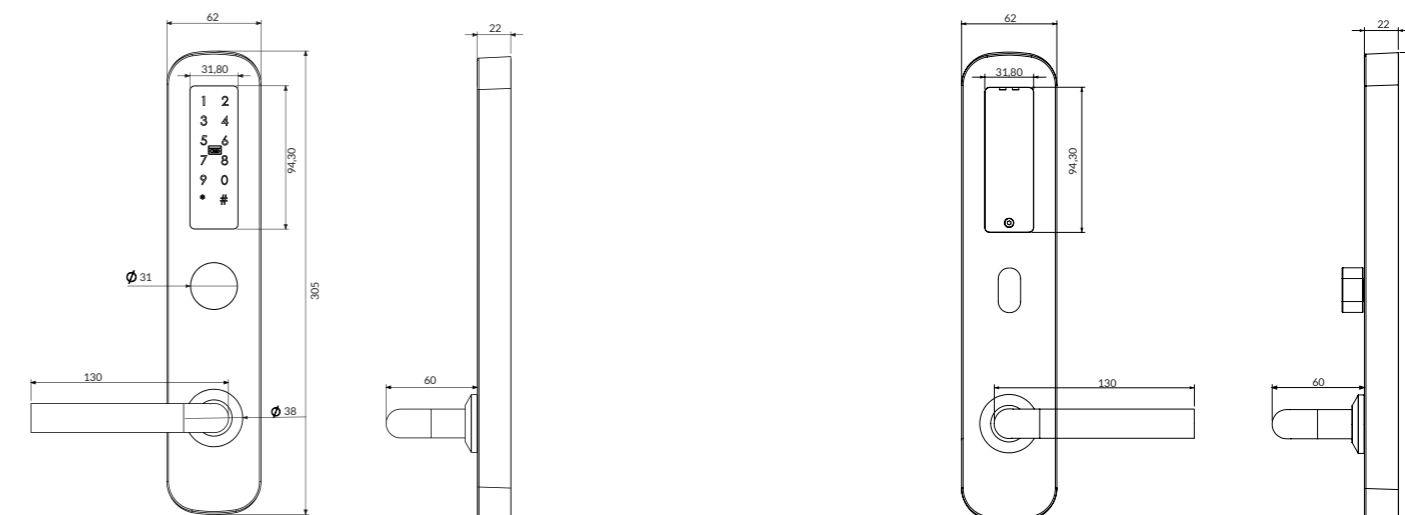

es.		fr.	
Matériel	Acero inoxidable	Matériel	Acier inoxydable
Métode d'ouverture	Código, Tarjeta, Wifi, BLE, APLICACIÓN, Llave mecánica	Métode d'ouverture	Code, carte, Wifi, BLE, APP, clé mécanique
Temps d'identification	<0,1 S	Temps d'identification	<0,1 S
Communication	Bluetooth 4.1; Mifare (13,56 MHz)	Communication	Bluetooth 4.1; Mifare (13,56 MHz)
Clavier	Si	Clavier	Oui
Bombillo	Bombillo ANSI	Cylindre	Cylindre ANSI
Compatibilité avec les serrures	De 70 mm a 92 mm	Compatibilité avec les serrures	De 70 mm à 92
Ouverture d'urgence	Micro USB	Ouverture d'urgence	Micro USB
Alimentation de secours	Llave mecánica	Alimentation de secours	Clé mécanique
Max. Puissance	CC 6 V (AAA * 4)	Max. Puissance	DC 6 v (AAA * 4)
Vie de la batterie	6V-MAX	Vie de la batterie	6V-MAX
Vie de la batterie	~ 12 meses	Max. Puissance	~ 12 mois
	Admite ~ 5,000 operaciones de apertura y cierre	Vie de la batterie	Prend en charge environ 5000 opérations d'ouverture et de fermeture
Leds	Blanco	Leds	Blanc
Alarme de batterie faible	En la aplicación y alarma por voz	Alarme de batterie faible	Dans l'application et l'alarme vocale
Consommation statique	<200 mA	Consommation statique	En dessous de 4,8V
Consommation	65µA	Consommation	<200 mA
Temps ouvert	5s; 10s; 15s; 30s; 60s; personalizado	Consommation	65µA
Numero de aberturas	~ 5,000 aberturas (1 año)	Temps ouvert	8s; 10s; 15S; 30s; 60s; Douane
Software Web	iTEC OnHospitality iTEC OnAccessPRO	Numero d'ouvertures	~ 5000 ouvertures (1 an)
Software de Windows	iTEC Hybrid	Logiciel Web	iTEC OnHospitality iTEC OnAccessPRO
Aplicaciones	iTEC iOA	Logiciel Windows	iTEC Hybrid
Compatibilidad	IOS 8 ; Android 5; o superior	Applications	iTEC iOA
Autonome	Si	Compatibilité	IOS 8; Android 5; ou supérieur
IP	IP56	Autonome	Oui
Poids	1,92 kilogramos	IP	IP56
Résistance à l'humidité	30% -95%	Poids	1,92 kilogrammes
Temp. De fonctionnement	-20°C ~ + 55°C	Résistance à l'humidité	30% -95%
Nº de code via APP	Ilimitado	Temp. De fonctionnement	-20 ° C à + 55 ° C
Nº de code auto-défini	150	Nº de code via APP	Illimité
Numéro d'empreinte digitale	N/A	Nº de code auto-défini	150
Numéro de carte IC	200	Numéro d'empreinte digitale	N/A
Niveaux d'utilisateurs	Si	Numéro de carte IC	200
Code de gestion	Si	Niveaux d'utilisateurs	Oui
Couleurs disponibles	Acero inoxidable satinado	Code de gestion	Oui
Installation	Residencias, Apartamentos, Hostales, Oficinas, AIRBNB, Hoteles	Couleurs disponibles	Acier inoxydable satiné
Épaisseur de la porte	30 mm ~ 110 mm	Installation	Residences, appartements, auberges, bureaux, AIRBNB, hôtels

iFP 03®

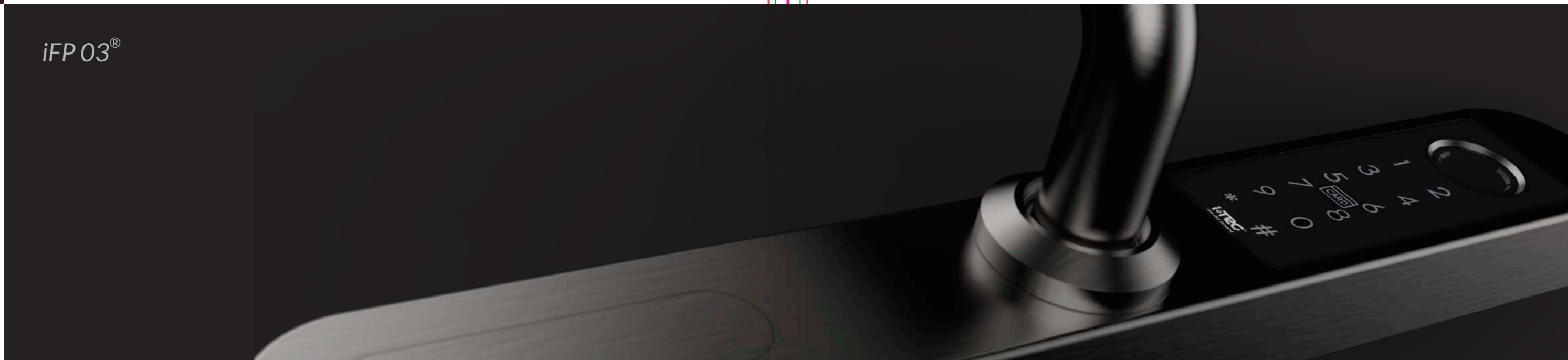

pt. O iFP 03 fornece uma abertura por impressão digital, código PIN ou por RFID, sendo a impressão digital pessoal e intransferível, aumentando desta forma a sua segurança.

en. iFP 03 provides a fingerprint, PIN code, or RFID aperture, with personal and non-transferable fingerprint, thereby increasing your security.

es. iFP 03 proporciona una huella digital, código PIN o apertura RFID, con huella digital personal e intransferible, aumentando así su seguridad.

fr. iFP 03 fournit une empreinte digitale, un code PIN ou une ouverture RFID, avec empreinte personnelle et non transférable, augmentant ainsi votre sécurité.



pt. Cores e puxadores disponíveis por pedido
en. Colors and handle available on request

es. Colores y manillas disponibles bajo pedido
fr. Couleurs et poignées disponibles sur demande



BZ



ALB



GUI



BRG



NAM



2023

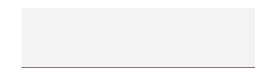

LSS
aço inoxidável lacado
lacquered stainless steel
acero inoxidable lacado
acier inoxydable laqué



SSAB
aço inoxidável latão antigo
stainless steel antique brass
acero inoxidable cobre antiguo
inox en l'aiton vieilli

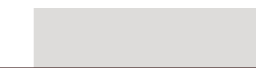

SSS
aço inoxidável satinado
satin stainless steel
acero inoxidable satin
acier inoxydable satiné



SSBT
aço inoxidável preto titânio
satin steel black titanium
acero inoxidable titanio negro
acier satiné titane noir



SSGR
aço inoxidável ouro rosa
stainless steel gold rose
acero inoxidable oro rosa
acier inoxydable rose

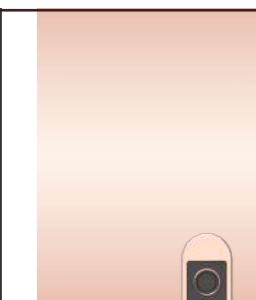
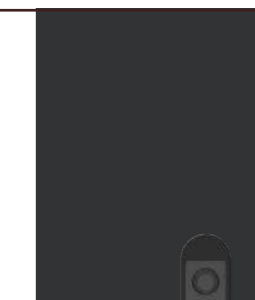
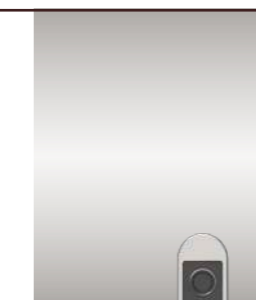
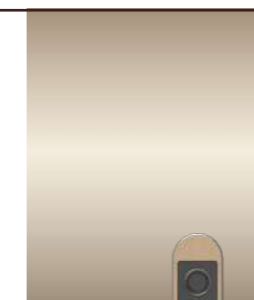
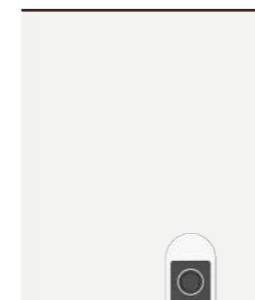

iFP 03[®]

Ficha Técnica
Datasheet
Hoja Técnica
Fiche Technique

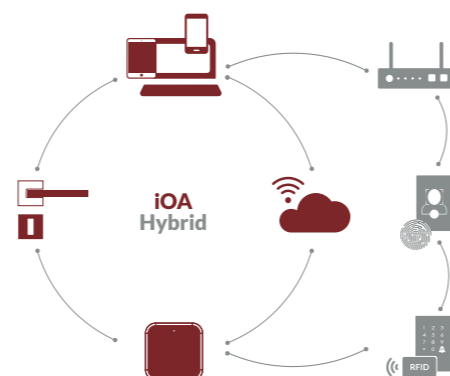

pt.		en.	
Material	Aço Inoxidável	Material	Stainless steel
Método de Abertura	Impressão Digital, Código, Cartão, Wifi, BLE, APP, Chave Mecânica	Opening method	Fingerprint, Code, Card, Wifi, BLE, APP, Mechanical Key
Tempo de Identificação	<0.1S	Identification time	<0.1S
Comunicação	Bluetooth 4.1; Mifare (13,56MHz)	Communication	Bluetooth 4.1; Mifare (13,56MHz)
Teclado Toque	Sim	Keyboard	Yes
Cilindro	Cilindro Europeu	Compatibility with locks	European Cylinder
Compatibilidade com fechaduras	Standard Europeu de 70mm a 92mm		European standard from 70mm to 92mm
Energia de Emergência	Micro USB	Emergency opening	Micro USB
Abertura de Emergência	Chave Mecânica	Emergency power	Mechanical Key
Potência	DC 6v (AAA*4)	Max. Powerful	DC 6v (AAA*4)
Máx. Potência	6V-MAX	Battery life	6V-MAX
Vida Útil da Bateria	~12 meses	Max. Powerful	~ 12 months
	Suporta ~ 5,000 Operações de Abertura & Fecho	Battery life	Supports ~ 5,000 Opening & Closing Operations
Leds	Branco	Leds	White
Alarme de Bateria Fraca	Na APP e Alarme por voz	Low battery alarm	In the APP and Voice Alarm
Consumo	<200mA		Below 4,8V
Consumo Estático	65µA	Static consumption	<200mA
Tempo Aberto	5s; 10s; 15S; 30s; 60s; personalizado	Consumption	65µA
Número de Aberturas	~5,000 Aberturas (1Ano)	Open time	7s; 10s; 15S; 30s; 60s; custom
Software Web	iTEC OnHospitality iTEC OnAccessPRO	Number of openings	~5,000 Openings (1Year)
Software Windows	iTEC Hybrid	Web Software	iTEC OnHospitality iTEC OnAccessPRO
APP's	iTEC iOA	Windows Software	iTEC Hybrid
Compatibilidade Stand Alone	IOS 8; Android 5; superior	APP's	iTEC iOA
IP	IP55	Compatibility	IOS 8; Android 5; or earlier
Peso	1,94 Kg	Autonomous	Yes
Resistencia à Humidade	30%-95%	IP	IP55
Temp. de Funcionamento	-20°C~+55°C	Weight	1,94 Kg
Nº de Código via APP	Ilimitado	Moisture resistance	30%-95%
Nº de Cód. auto-definido	150	Temp. Operating	-20°C~+55°C
Nº de Impressão Digital	150	Code number via APP	Unlimited
Nº do cartões de IC	200	Self-defined code number	150
Níveis de Usuários	Sim	Fingerprint number	150
Código de Gestão	Sim	IC card number	200
Cores Disponíveis	Aço Inox Satinado	User levels	Yes
Instalação	Residências, Apartamentos, Residenciais, Escritórios, AIRBNB, Hotéis	Management code	Yes
		Available colors	Satin Stainless Steel
		Installation	Residences, Apartments, Hostels, Offices, AIRBNB, Hotels
Espessura de porta	30mm~110mm	Door thickness	30mm~110mm

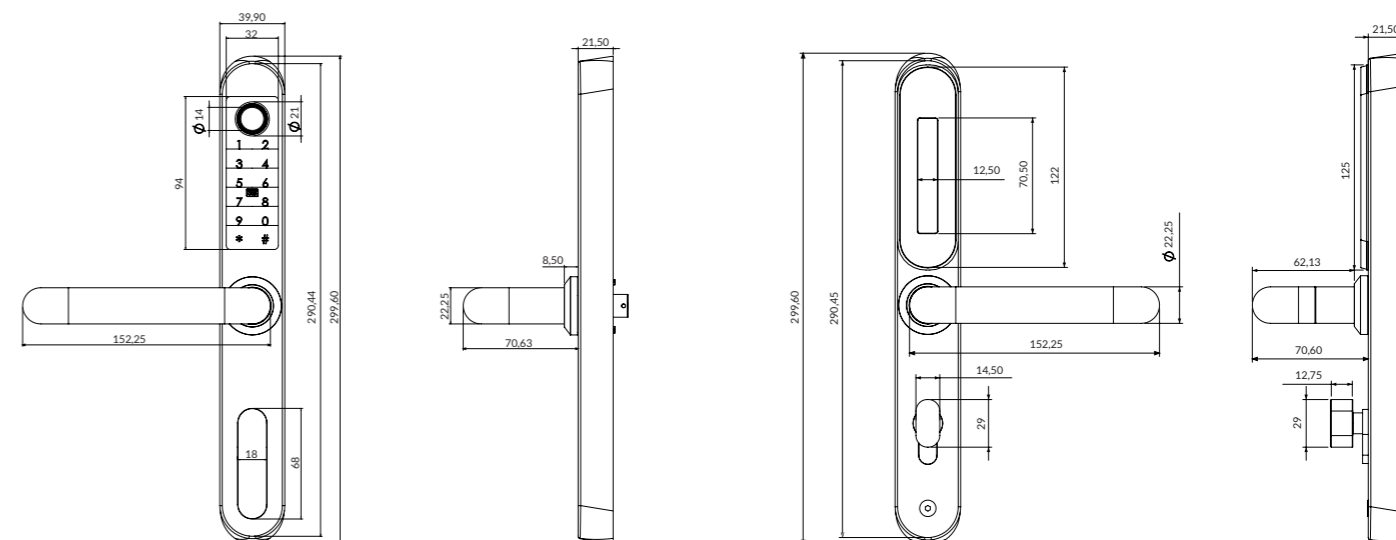

es.		fr.	
Material	Acero inoxidable	Matériel	Acier inoxydable
Método de apertura	Huella digital, Código, Tarjeta, Wifi, BLE, APLICACIÓN, Llave mecánica	Méthode d'ouverture	Empreinte digitale, Code, Carte, Wifi, BLE, APP, Clé mécanique
Tiempo de identificación	<0,1S	Temps d'identification	<0,1 S
Comunicación	Bluetooth 4.1; Mifare (13,56 MHz)	Communication	Bluetooth 4.1; Mifare (13,56 MHz)
Teclado	Sí	Clavier	Oui
Bombillo	Bombillo europeo	Compatibilité avec les serrures	Cylindre européen
Tipo de cerraduras	Estándar europeo de 70 mm a 92 mm		Norme européenne de 70 mm à 92 mm
Apertura de emergencia	Llave mecánica	Ouverture d'urgence	Micro USB
Duración de la batería	CC 6 V (AAA * 4)	Alimentation de secours	Clé mécanique
Energía máxima	6V-MAX	Max. Puissance	DC 6 v (AAA * 4)
Duración de la Bateria	~ 12 meses	Vie de la batterie	6V-MAX
	Admite ~ 5,000 operaciones de apertura y cierre	Max. Puissance	~ 12 mois
		Vie de la batterie	Prend en charge environ 5000 opérations d'ouverture et de fermeture
Leds	Blanco	Leds	Blanc
Alarma de batería baja	En la aplicación y alarma por voz	Alarme de batterie faible	Dans l'application et l'alarme vocale
	Por debajo de 4,8 V		En dessous de 4,8V
Consumo	<200 mA	Consommation statique	<200 mA
Consumo estático	65µA	Consumption	65µA
Tiempo Aberto	5s; 10s; 15s; 30s; 60s; personalizado	Temps ouvert	7s; 10s; 15S; 30s; 60s; Douane
Numero de aperturas	~ 5,000 aperturas (1 año)	Nombre d'ouvertures	~ 5000 ouvertures (1 an)
Software de Windows	iTEC OnHospitality iTEC OnAccessPRO	Logiciel Web	iTEC OnHospitality iTEC OnAccessPRO
APP's	iTEC Hybrid	Logiciel Windows	iTEC Hybrid
Compatibilidad Stand Alone	IOS 8; Android 5; o superior	Applications	iTEC iOA
IP	IP55	Compatibilité	IOS 8; Android 5; ou supérieur
Peso	1,94 kilogramos	Autonome	Oui
Resistencia a la humedad	30% -95%	IP	IP55
Temperatura. de operación	-20°C ~ + 55°C	Poids	1,94 kilogrammes
No. de código via APP	Ilimitado	Résistance à l'humidité	30%-95%
No. Código autodefinido	150	Temp. De fonctionnement	-20 ° C à + 55 ° C
Número de huella digital	150	N ° de code via APP	Illimité
Número de tarjeta IC	200	N ° de code auto-défini	150
Niveles de usuario	sí	Numéro d'empreinte digitale	150
Código de gestión	sí	Numéro de carte IC	200
Colores disponibles	Acero inoxidable satinado	Niveaux d'utilisateurs	Oui
Instalación	Residencias, Apartamentos, Hostales, Oficinas, AIRBNB, Hoteles	Code de gestion	Oui
		Couleurs disponibles	Acier inoxydable satiné
Espesor de puerta	30 mm ~ 110 mm	Installation	Résidences, appartements, auberges, bureaux, AIRBNB, hôtels
		Épaisseur de la porte	30mm~110mm

iFP 03 cUL®

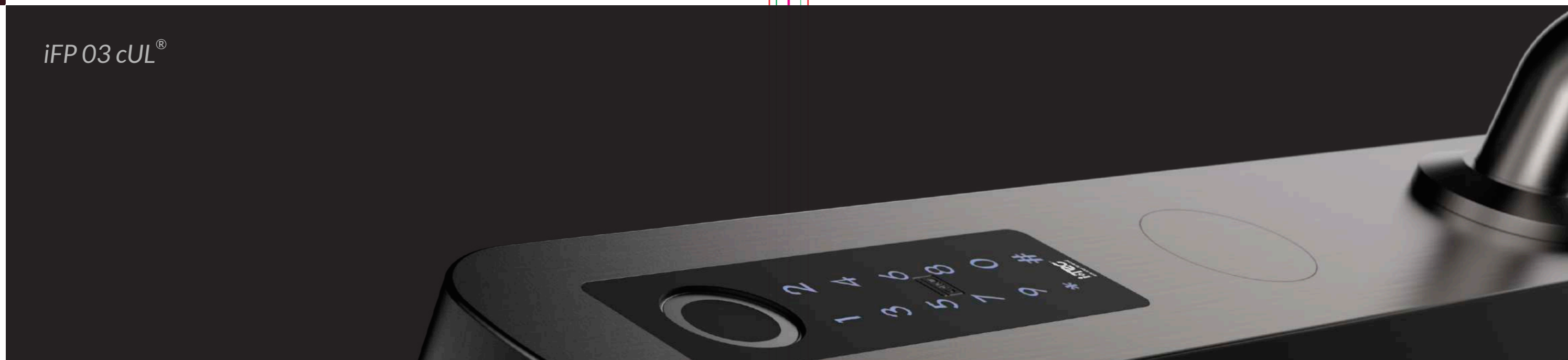

pt. A iFP 03 cUL inclui os mesmos recursos da iCode 03 cUL. Adiciona funcionalidades como a impressão digital, uma validação de acesso pessoal e intransferível, que proporciona o aumento da sua segurança.

en. The iFP 03 cUL includes the same features as iCode 03 cUL. Adding fingerprint, a personal and non-transferable access validation, thereby increasing your security.

es. El iFP 03 cUL incluye las mismas funciones que el iCode 03 cUL. Añadiendo huella dactilar, una validación de acceso personal e intransferible, aumentando así su seguridad.

fr. L'iFP 03 cUL comprend les mêmes fonctionnalités que l'iCode 03 cUL. Ajout d'empreinte digitale, une validation d'accès personnelle et non transférable, augmentant ainsi votre sécurité.



pt. Cores e puxadores disponíveis por pedido
en. Colors and handle available on request

es. Colores y manillas disponibles bajo pedido
fr. Couleurs et poignées disponibles sur demande

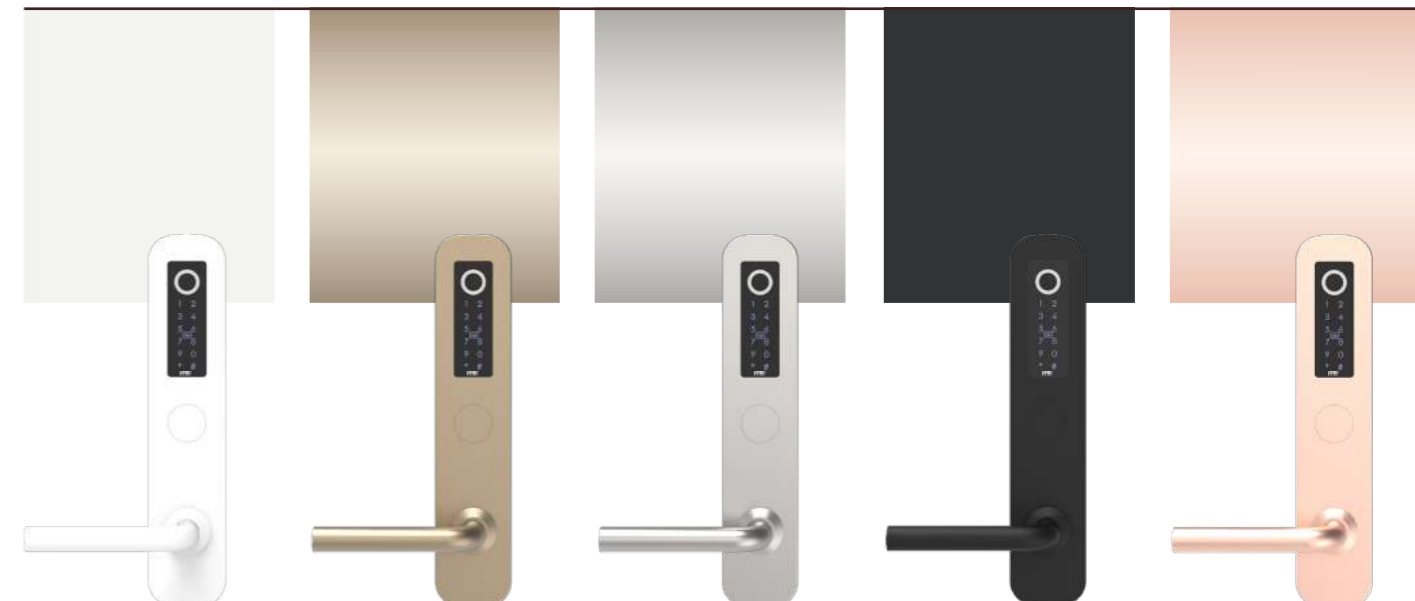
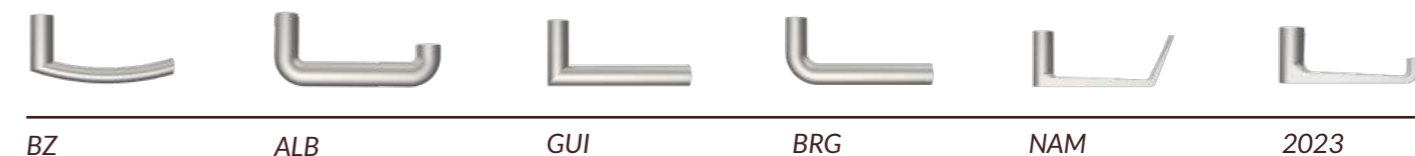

iFP 03 cUL[®]

Ficha Técnica

Datasheet

Hoja Técnica

Fiche Technique

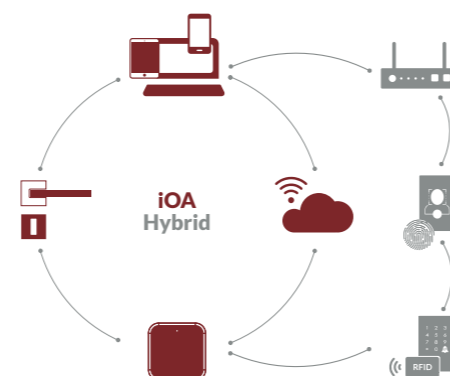

pt.		en.	
Material	Aço Inoxidável	Material	Stainless steel
Método de Abertura	Impressão Digital, Código, Cartão, Wifi, BLE, APP, Chave Mecânica	Opening method	Fingerprint, Code, Card, Wifi, BLE, APP, Mechanical Key
Tempo de Identificação	<0.1S	Identification time	<0.1S
Comunicação	Bluetooth 4.1; Mifare (13,56MHz)	Communication	Bluetooth 4.1; Mifare (13,56MHz)
Teclado Toque	Sim	Keyboard	Yes
Cilindro	Cilindro ANSI	Compatibility with locks	ANSI Cylinder
Compatibilidade com fechaduras	De 70mm a 92mm		From 70mm to 92mm
Energia de Emergência	Micro USB	Emergency opening	Micro USB
Abertura de Emergência	Chave Mecânica	Emergency power	Mechanical Key
Potência	DC 6v (AAA*4)	Max. Powerful	DC 6v (AAA*4)
Máx. Potência	6V-MAX	Battery life	6V-MAX
Vida Útil da Bateria	~12 meses	Max. Powerful	~ 12 months
	Suporta ~ 5,000 Operações de Abertura & Fecho	Battery life	Supports ~ 5,000 Opening & Closing Operations
Leds	Branco	Leds	White
Alarme de Bateria Fraca	Na APP e Alarme por voz	Low battery alarm	In the APP and Voice Alarm
Consumo	<200mA		Below 4,8V
Consumo Estático	65µA	Static consumption	<200mA
Tempo Aberto	5s; 10s; 15s; 30s; 60s; personalizado	Consumption	65µA
Número de Aberturas	~5,000 Aberturas (1Ano)	Open time	7s; 10s; 15s; 30s; 60s; custom
Software Web	iTEC OnHospitality iTEC OnAccessPRO	Number of openings	~5,000 Openings (1Year)
Software Windows	iTEC Hybrid	Web Software	iTEC OnHospitality iTEC OnAccessPRO
APP's	iTEC iOA	Windows Software	iTEC Hybrid
Compatibilidade	IOS 8; Android 5; e superior	APP's	iTEC iOA
Stand Alone	Sim	Compatibility	IOS 8; Android 5; or earlier
IP	IP55	Autonomous	Yes
Peso	1,94 Kg	IP	IP55
Resistencia à Humidade	30%-95%	Weight	1,94 Kg
Temp. de Funcionamento	-20°C~+55°C	Moisture resistance	30%-95%
Nº de Código via APP	Ilimitado	Temp. Operating	-20°C~+55°C
Nº de Cód. auto-definido	150	Code number via APP	Unlimited
Nº de Impressão Digital	150	Self-defined code number	150
Nº do cartões de IC	200	Fingerprint number	150
Níveis de Usuários	Sim	IC card number	200
Código de Gestão	Sim	User levels	Yes
Cores Disponíveis	Aço Inox Satinado	Management code	Yes
Instalação	Residências, Apartamentos, Residenciais, Escritórios, AIRBNB, Hotéis	Available colors	Satin Stainless Steel
		Installation	Residences, Apartments, Hostels, Offices, AIRBNB, Hotels
Espessura de porta	30mm~110mm	Door thickness	30mm~110mm

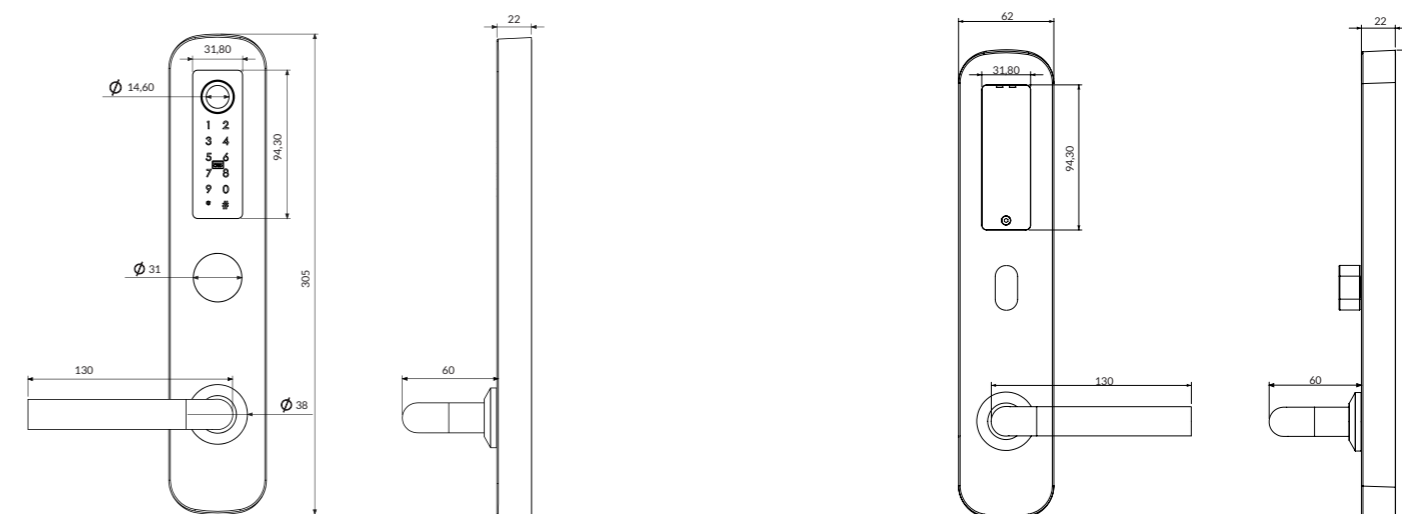

es.		fr.	
Material	Acero inoxidable	Matériel	Acier inoxydable
Método de apertura	Huella digital, Código, Tarjeta, Wifi, BLE, APLICACIÓN, Llave mecánica	Méthode d'ouverture	Empreinte digitale, Code, Carte, Wifi, BLE, APP, Clé mécanique
Tiempo de identificación	<0,1 S	Temps d'identification	<0,1 S
Comunicación	Bluetooth 4.1; Mifare (13,56 MHz)	Communication	Bluetooth 4.1; Mifare (13,56 MHz)
Teclado	Sí	Clavier	Oui
Bombillo	Bombillo ANSI	Compatibilité avec les serrures	Cylindre ANSI
Tipo de cerraduras	De 70 mm a 92	Ouverture d'urgence	De 70 mm à 92 Micro USB
Apertura de emergencia	Micro USB	Alimentation de secours	Clé mécanique
Duración de la batería	Llave mecánica	Max. Puissance	DC 6 v (AAA * 4)
Energia maxima	CC 6 V (AAA * 4)	Vie de la batterie	6V-MAX
Duración de la Bateria	6V-MAX	Max. Puissance	~ 12 mois
	~ 12 meses	Vie de la batterie	Prend en charge environ 5000 opérations d'ouverture et de fermeture
	Admite ~ 5,000 operaciones de apertura y cierre	Leds	Blanc
Leds	Blanco	Alarme de batterie faible	Dans l'application et l'alarme vocale
Alarma de batería baja	En la aplicación y alarma por voz		En dessous de 4,8V
Consumo	Por debajo de 4,8 V	Consommation statique	<200 mA
Consumo estático	<200 mA	Consummation	65µA
Tiempo Aberto	65µA	Temps ouvert	7s; 10s; 15s; 30s; 60s; Douane
Numero de aperturas	5s; 10s; 15s; 30s; 60s; personalizado	Nombre d'ouvertures	~ 5000 ouvertures (1 an)
Software Web	~ 5,000 aperturas (1 año)	Logiciel Web	iTEC OnHospitality iTEC OnAccessPRO
Software de Windows	iTEC OnHospitality iTEC OnAccessPRO	Logiciel Windows	iTEC Hybrid
Aplicaciones	iTEC Hybrid	Applications	iTEC iOA
Compatibilidad	iTEC iOA	Compatibilité	IOS 8; Android 5; ou supérieur
Stand Alone	Sim	Autonome	Oui
IP	IP55	IP	IP55
Peso	1,94 kilogramos	Poids	1,94 kilogrammes
Resistencia a la humedad	30% -95%	Résistance à l'humidité	30% -95%
Temperatura. de operación	-20°C ~ + 55°C	Temp. De fonctionnement	-20 ° C à + 55 ° C
No. de código via APP	Ilimitado	N ° de code via APP	Ilimitado
No. Código autodefinido	150	N ° de code auto-défini	150
Número de huella digital	150	Numéro d'empreinte digitale	150
Número de tarjeta IC	200	Numéro de carte IC	200
Niveles de usuario	Sí	Niveaux d'utilisateurs	Oui
Código de gestión	Sí	Code de gestion	Oui
Colores disponibles	Sí	Couleurs disponibles	Acier inoxydable satiné
Instalación	Acero inoxidable satinado	Installation	Residences, appartements, auberges, bureaux, AIRBNB, hôtels
Espesor de puerta	30 mm ~ 110 mm	Épaisseur de la porte	30mm~110mm



iClassic®
iClassic cUL®



iClassic®
iClassic cUL®



pt. Reconhecida pela sua confiabilidade, robustez e alta tecnologia. Com esta solução, o processo de abertura é feita através de dispositivos de proximidade RFID (Mifare). Totalmente sem fio e com baixo consumo de energia. Poderá configurar todos os acessos por meio do nosso software.

en. Recongnized for its reliability, rubost and high technologic. With this solution, the opening process is by RFID (Mifare) proximity devices. Totally wire free and with low energy consumption. You can also setup all access through our software. Available with BLE system.

es. Reconocida por su garantía, solidez y su alta tecnología. Con esta solución, el proceso de Apertura de estos dispositivos estaran mas proximos de RFID (Mifare). Totalmente sin cables y con bajo consumo de energia. Puede configurar todo el acceso a través de nuestro software.

fr. Reconnu pour sa fiabilité, sa fiabilité et sa haute technologie. Avec cette solution, le processus d'ouverture se fait par des dispositifs de proximité RFID (Mifare). Totalement sans fil et avec une faible consommation d'énergie. Vous pouvez également configurer tous les accès via notre logiciel.



pt. Cores e puxadores disponíveis por pedido
en. Colors and handle available on request

es. Colores y manillas disponibles bajo pedido
fr. Couleurs et poignées disponibles sur demande



LSS aço inoxidável lacado lacquered stainless steel acero inoxidable lacado acier inoxydable laqué	SSAB aço inoxidável latão antigo stainless steel antique brass acero inoxidable cobre antiguo inox en laiton vieilli	SSS aço inoxidável satinado satin stainless steel acero inoxidable satin acier inoxydable satiné	SSBT aço inoxidável preto titânio satin steel black titanium acero inoxidable titanio negro acier satiné titane noir	SSGR aço inoxidável ouro rosa stainless steel gold rose acero inoxidable oro rosa acier inoxydable rose
---	---	---	---	--



iClassic® iClassic cUL®

Ficha Técnica

Datasheet

Hoja Técnica

Fiche Technique

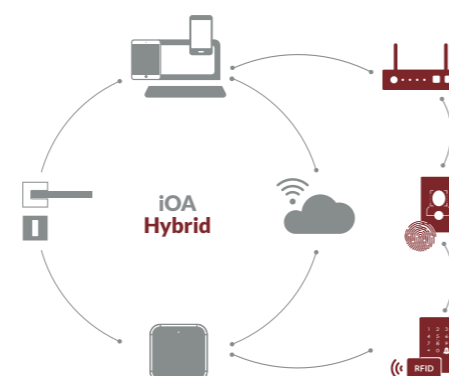

pt.

Material	Aço Inoxidável
Método de Abertura	Cartão, chave mecânica
Tempo de Identificação	<0.1S
Comunicação	N/A
	Mifare (13,56MHz)
Teclado Toque	Não
Cilindro	Meio cilindro Redondo ANSI
Compatibilidade com fechaduras	Fechadura ANSI
Energia de Emergência	N/A
Abertura de Emergência	Chave Mecânica
Potência	DC 6v (AAA*4)
Máx. Potência	6V-MAX
Vida Útil da Bateria	~12 meses
	Suporta ~ 5,000 Operações de Abertura & Fecho
	Verde, Vermelho
Leds	3 bips
Alarme de Bateria Fraca	Abaixo de 4,8V
	<300mA
Consumo	12µA
Consumo Estático	7 s
Tempo Aberto	~5,000 Aberturas (1Ano)
Número de Aberturas	iTEC Hybrid
Software Windows	Opção (Opção Integração)
APP's	N/A
Stand Alone	IP44
IP	3,20 Kg
Peso	Humidity Resistance
Resistência à Humidade	30%-95%
Temp. de Funcionamento	-20°C~+ 65°C
Nº de Código via APP	N/A
Nº de Cód. auto-definido	N/A
Nº de Impressão Digital	N/A
Nº de cartões de IC	200
Níveis de Usuários	Sim
Código de Gestão	N/A
Cores Disponíveis	Inox Satin. PVD, outras
Instalação	Residencias, Apartamentos, Residenciais, Escritórios, AIRBNB, Hotéis
	Door thickness
Espessura de porta	45mm ~110mm

en.

Material	Stainless steel
Opening Method	Card, Mechanical Key
Identification Time	<0.1S
Communication	N/A
Keypad	Mifare (13,56MHz)
Cylinder Type	ANSI Round half cylinder
Compatibility with locks	Ansi Lock
Emergency Power	N/A
Emergency Opening	Mechanical Key
Voltage	DC 6v (AAA*4)
Max. Power	6V-MAX
Battery Life	~ 12 months
	Supports ~ 5,000 Opening & Closing Operations
	Green, red
	3 bips
	Below 4,8V
	<300mA
Consumption	12µA
Static Consumption	7 s
Time Open	~5,000 Openings (1Year)
Number of Openings	iTEC Hybrid
Windows software	Option (Integration Option)
APP's	N/A
Stand Alone	IP44
IP	3,20 Kg
Weight	Humidity Resistance
Humidity Resistance	30%-95%
Temp. of Operation	-20°C~+ 65°C
Code No. via APP	N/A
Self-defined Code No.	N/A
Fingerprint Number	N/A
IC card number	200
User Levels	Yes
Management Code	N/A
Available Colors	Inox Satin. PVD, other
Installation	Residences, Apartments, Hostels, Offices, AIRBNB, Hotels
	Door thickness
	45mm ~110mm

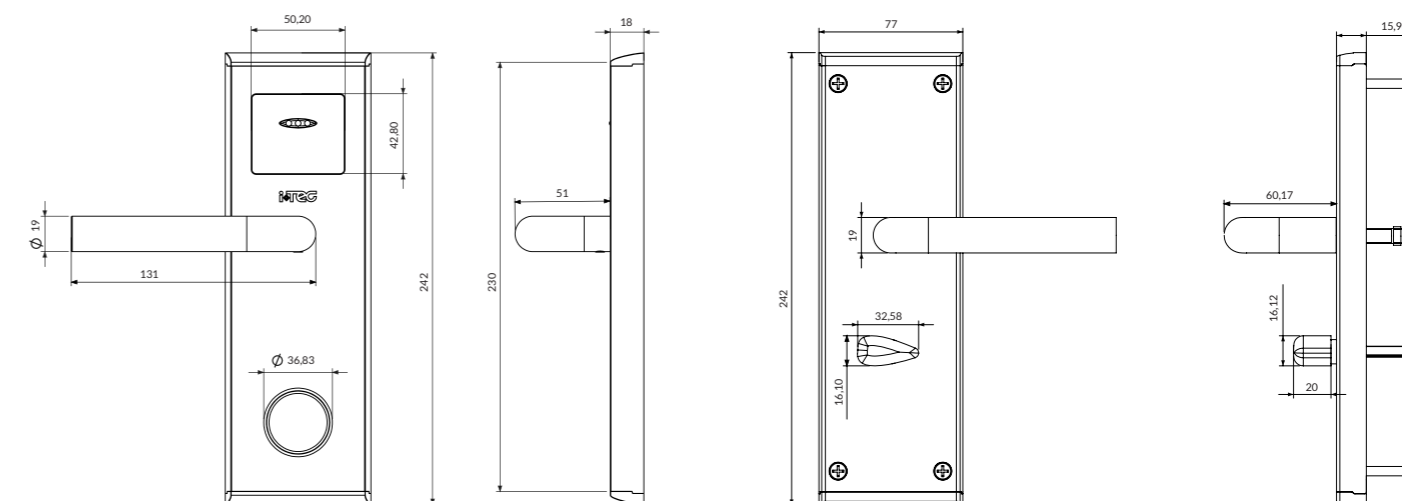

es.

Material	Acero inoxidable
Método de apertura	Tarjeta, llave mecánica
Tiempo de identificación	<0,1 S
Comunicación	Mifare (13,56 MHz)
Teclado	No
Bombillo	Medio cilindro redondo ANSI
Tipo de cerraduras	Cerradura Ansi
	N/A
Voltaje	Llave mecánica
Apertura de emergencia	CC 6 V (AAA * 4)
Duración de la batería	6V-MAX
Energía máxima	~ 12 meses
Duración de la Bateria	Admite ~ 5,000 operaciones de apertura y cierre
	Verde rojo
	3 picos
	Por debajo de 4,8 V
	<300 mA
Consumo	12µA
Consumo estático	7 s
Tiempo Aberto	~ 5,000 aperturas (1 año)
Numero de aperturas	iTEC Hybrid
Software de Windows	Opcción (Opcción de Integración)
APP's	N/A
Stand Alone	IP44
IP	3,20 kilogramos
Peso	30% -95%
Resistencia a la humedad	-20°C ~ + 65°C
Temperatura. de operación	N/A
No. de código vía APP	N/A
No. Código autodefinido	N/A
Número de huella digital	N/A
Número de tarjeta IC	200
Niveles de usuario	Sí
Código de gestión	N/A
Colores disponibles	Inox Satin. PVD, otro
Instalación	Residencias, Apartamentos, Hostales, Oficinas, AIRBNB, Hoteles
	Espeor de puerta
	45mm ~ 110 mm

fr.

Matériel	Acier inoxydable
Méthode d'ouverture	Carte, clé mécanique
Temps d'identification	<0,1 S
Communication	Mifare (13,56 MHz)
Clavier	Non
Compatibilité avec les serrures	Demi-cylindre rond ANSI
Ouverture d'urgence	Ansi Lock
Alimentation de secours	N/A
Max. Puissance	Clé mécanique
Vie de la batterie	DC 6 v (AAA * 4)
Max. Puissance	6V-MAX
Vie de la batterie	~ 12 mois
	Prend en charge environ 5000 opérations d'ouverture et de fermeture
	Vert rouge
	3 bips
	En dessous de 4,8V
	<300 mA
Consommation statique	12µA
Consommation	7 s
Temps ouvert	~ 5000 ouvertures (1 an)
Nombre d'ouvertures	iTEC Hybrid
Logiciel Windows	Option (Possibilité d'intégration)
App's	N/A
Autonome	IP44
IP	3,20 kilogrammes
Poids	30% -95%
Résistance à l'humidité	-20 ° C à + 65 ° C
Temp. De fonctionnement	N/A
N ° de code via APP	N/A
N ° de code auto-défini	N/A
Numéro d'empreinte digitale	N/A
Numéro de carte IC	200
Niveaux d'utilisateurs	Oui
Code de gestion	N/A
Couleurs disponibles	Inox Satin. PVD, autre
Installation	Residences, appartements, auberges, bureaux, AIRBNB, hôtels
	Épaisseur de la porte
	45mm à 110 mm

iClassic SP®



pt. Simplicidade e criatividade são palavras que podem descrever o iClassic SP. É controlado através de cartão de proximidade RFID e/ou chave mecânica com entrada oculta.

en. Simplicity and creativity are words that can describe iClassic SP. Runs through RFID proximity card and/or mechanical key with hidden entrance.

es. Simplicidad y creatividad son palabras que pueden describir este iClassic SP. Es controlado a través de un carton de proximidad RFID y/o llave mecanica con entrada oculta.

fr. Simplicité et créativité sont des mots qui peuvent décrire iClassic SP. Fonctionne avec une carte de proximité RFID et/ou une clé mécanique à entrée cachée.

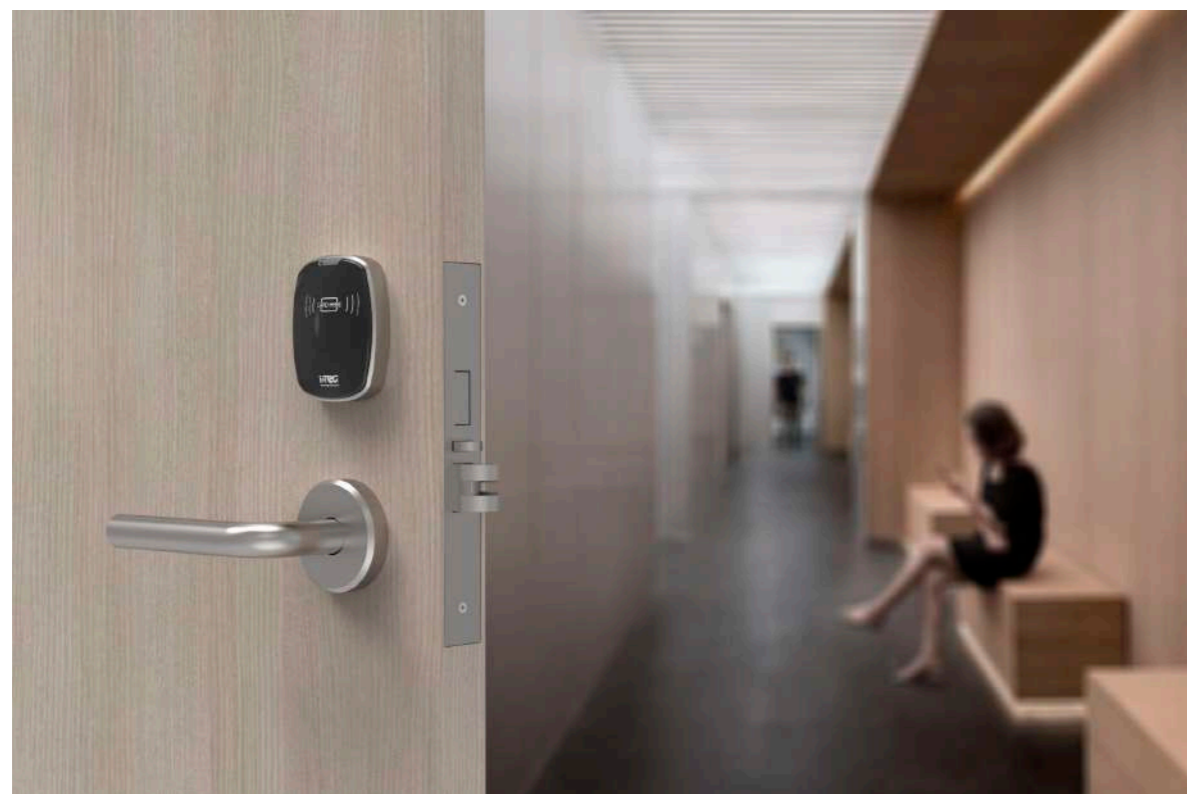

pt. Cores e puxadores disponíveis por pedido
en. Colors and handle available on request

es. Colores y manillas disponibles bajo pedido
fr. Couleurs et poignées disponibles sur demande

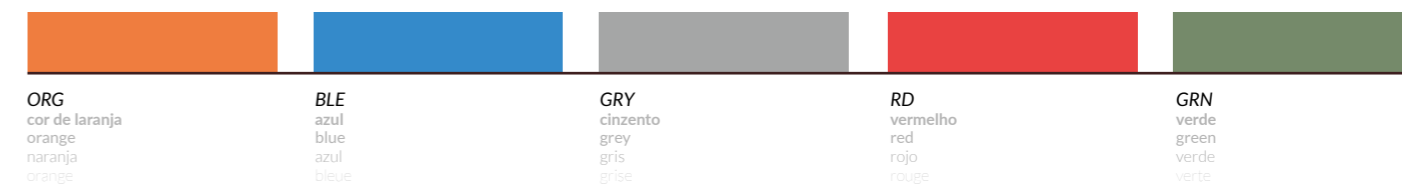

iClassic SP[®]**Ficha Técnica**

Datasheet

Hoja Técnica

Fiche Technique

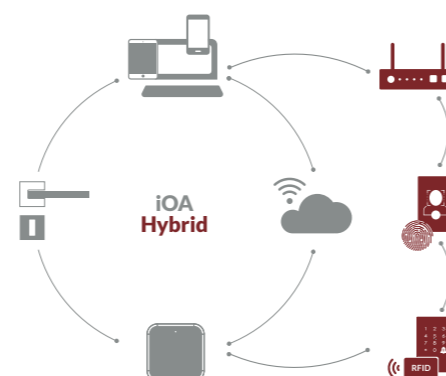
**pt.**

Material	Liga Metálica, Aço Inox, ABS
Método de Abertura	Cartão, chave mecânica
Tempo de Identificação	<0.1S
Comunicação	Mifare (13,56MHz)
Teclado Toque	Não
Cilindro	Meio cilindro Redondo ANSI
Compatibilidade com fechaduras	Fechadura ANSI
Energia de Emergência	N/A
Abertura de Emergência	Chave Mecânica
Potência	DC 6v (AAA*4)
Máx. Potência	6V-MAX
Vida Útil da Bateria	~12 meses
	Suporta ~ 5,000 Operações de Abertura & Fecho
	Verde, Vermelho
Leds	
Alarme de Bateria Fraca	3 bips
	Abaixo de 4,8V
Consumo	<300mA
Consumo Estático	12µA
Tempo Aberto	7 s
Número de Aberturas	~5,000 Aberturas (1Ano)
Software Web	iTEC OnHospitality iTEC OnAccessPRO
Software Windows	iTEC Hybrid
APP's	iTEC iOA
Compatibilidade	Opção (Opção Integração)
Stand Alone	N/A
IP	IP44
Peso	3,20 Kg
Resistencia à Humidade	30%-95%
Temp. de Funcionamento	-20°C~+ 65°C
Nº de Código via APP	N/A
Nº de Cód. auto-definido	N/A
Nº de Impressão Digital	N/A
Nº do cartões de IC	200
Níveis de Usuários	Sim
Código de Gestão	N/A
Cores Disponíveis	Inox Satin. PVD, outras
Instalação	Residencias, Apartamentos, Residenciais, Escritórios, AIRBNB, Hotéis
Espessura de porta	45mm ~110mm

en.

Material	Alloy Metal, Stainless steel, ABS
Opening Method	Card, Mechanical Key
Identification Time	<0.1S
Communication	Mifare (13,56MHz)
Keypad	No
Cylinder Type	ANSI Round half cylinder
Compatibility with locks	Ansi Lock
Emergency Power	N/A
Emergency Opening	Mechanical Key
Voltage	DC 6v (AAA*4)
Max. Power	6V-MAX
Battery Life	~ 12 months
	Supports ~ 5,000 Opening & Closing Operations
	Green, red
	3 bips
	Below 4,8V
	<300mA
	12µA
	7 s
	~5,000 Openings (1Year)
	iTEC OnHospitality
	iTEC OnAccessPRO
	iTEC Hybrid
	iTEC iOA
	Option (Integration Option)
	N/A
	IP44
	3,20 Kg
	30%-95%
	-20°C~+ 65°C
	N/A
	N/A
	N/A
	200
	Yes
	N/A
	Inox Satin. PVD, other
	Residences, Apartments, Hostels, Offices, AIRBNB, Hotels
	45mm ~110mm

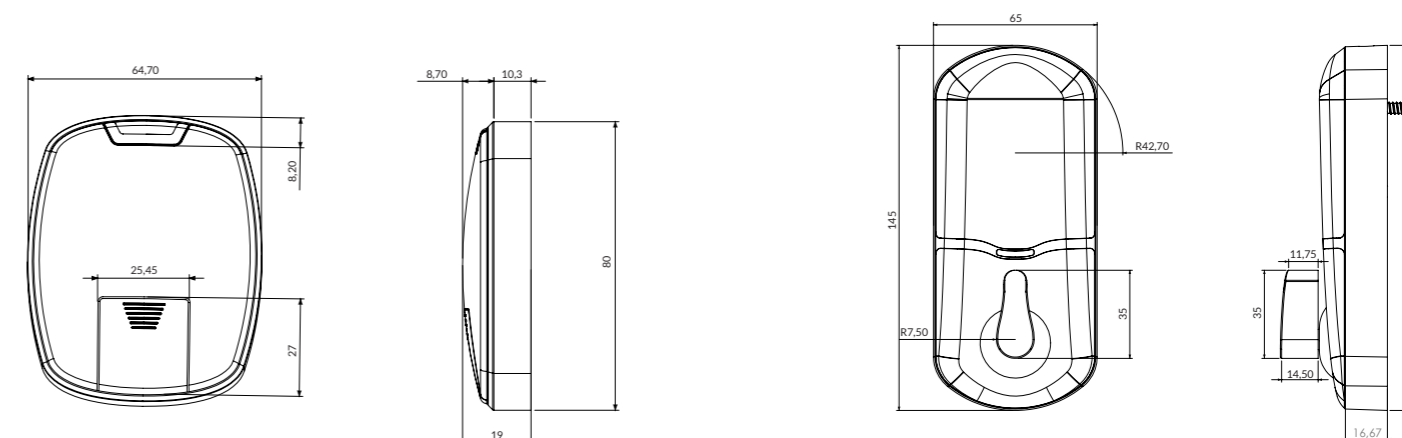
**es.**

Material	Metal, Acero Inoxidable, ABS
Método de apertura	Tarjeta, llave mecánica
Tiempo de identificación	<0,1 S
Comunicación	Mifare (13,56 MHz)
Teclado	No
Bombillo	Medio cilindro redondo ANSI
Tipo de cerraduras	Cerradura Ansi
Voltaje	N/A
Apertura de emergencia	Llave mecánica
Duración de la batería	CC 6 V (AAA * 4)
Energía máxima	6V-MAX
Duración de la Bateria	~ 12 meses
	Admite ~ 5,000 operaciones de apertura y cierre
	Verde, rojo
	3 picos
	Por debajo de 4,8 V
	<300 mA
	12µA
	7 s
	~ 5,000 aperturas (1 año)
	iTEC OnHospitality
	iTEC OnAccessPRO
	iTEC Hybrid
	iTEC iOA
	Opción (Opción de Integración)
	N/A
	IP44
	3,20 kilogramos
	30% -95%
	-20°C ~ + 65°C
	N/A
	N/A
	N/A
	200
	Sí
	N/A
	Inox Satin. PVD, otro
	Residencias, Apartamentos, Hostales, Oficinas, AIRBNB, Hoteles
	45mm ~ 110mm

fr.

Matériel	Alliage de métal, acier inoxydable, ABS
Méthode d'ouverture	Carte, clé mécanique
Temps d'identification	<0,1 S
Communication	Mifare (13,56 MHz)
Clavier	Non
Compatibilité avec les serrures	Demi-cylindre rond ANSI
Ouverture d'urgence	N/A
Alimentation de secours	Clé mécanique
Max. Puissance	DC 6 v (AAA * 4)
Vie de la batterie	6V-MAX
Max. Puissance	~ 12 mois
Vie de la batterie	Prend en charge environ 5000 opérations d'ouverture et de fermeture
	Vert, rouge
	3 bips
	En dessous de 4,8V
	<300 mA
	12µA
	7 s
	~ 5000 ouvertures (1 an)
	iTEC OnHospitality
	iTEC OnAccessPRO
	iTEC Hybrid
	iTEC iOA
	Option (Possibilité d'intégration)
	N/A
	IP44
	3,20 kilogrammes
	30% -95%
	-20 °C à + 65 °C
	N/A
	N/A
	N/A
	200
	Oui
	N/A
	Inox Satin. PVD, autre
	Résidences, appartements, auberges, bureaux, AIRBNB, hôtels
	45mm à 110mm

Euro Invisible®

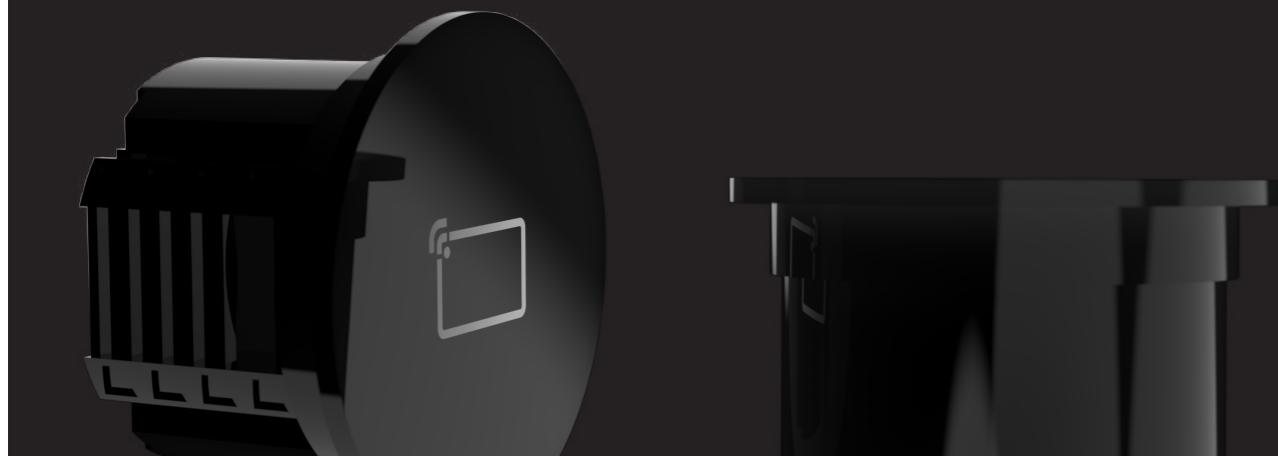

- AIA
- RFID
- 3x CRIPZETA
- CE
- IP64

pt. A fechadura Euro Invisible, um pack conjunto, confere um visual minimalista ao processo de abertura por cartão RFID (Mifare), através de um design elegante, prezado pela simplicidade estética em contexto de uso. Possibilita também a abertura manual além cartão e é compatível com o aplicativo iTEC Hybrid.

en. The Euro Invisible Lock, an pack, provide a minimalist look to the RFID card (Mifare) opening process, through an elegant design that cares about aesthetic simplicity at the moment of use. It also has the option of manual opening in addition to the card and is compatible with iTEC Hybrid.

es. El Euro Lock Invisible, un pack, aporta un aspecto minimalista al proceso de apertura de la tarjeta RFID (Mifare), a través de un diseño elegante que se preocupa por la simplicidad estética en el momento de su uso. También tiene la opción de apertura manual adicional a la tarjeta y es compatible con la aplicación iTEC Hybrid.

fr. L'invisible Euro Lock, un pack, donne un aspect minimaliste au processus d'ouverture de la carte RFID (Mifare), grâce à un design élégant qui se soucie de la simplicité esthétique au moment de l'utilisation. Il a également la possibilité d'une ouverture manuelle en complément de la carte et est compatible avec l'application iTEC Hybrid.

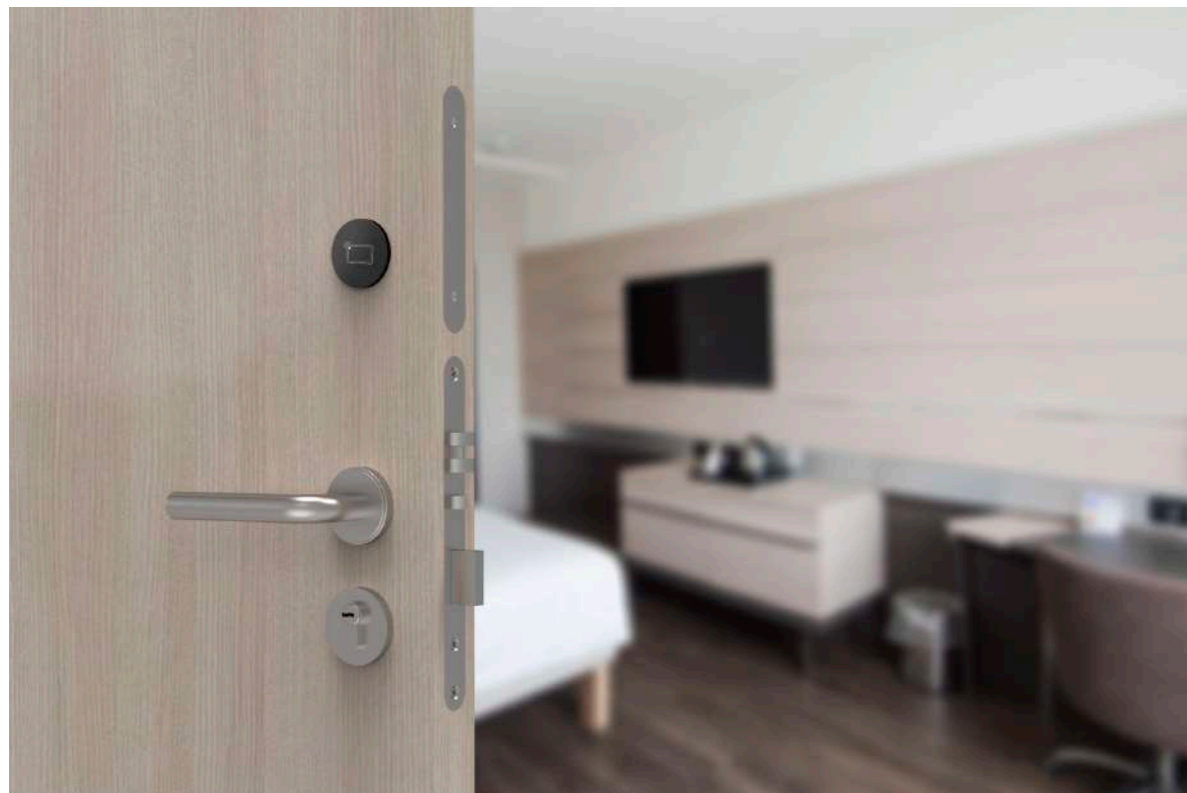

- itec
- Access
- itec
- Access pro
- HY
- hybrid

pt. Cores e puxadores disponíveis por pedido
en. Colors and handle available on request

es. Colores y manillas disponibles bajo pedido
fr. Couleurs et poignées disponibles sur demande

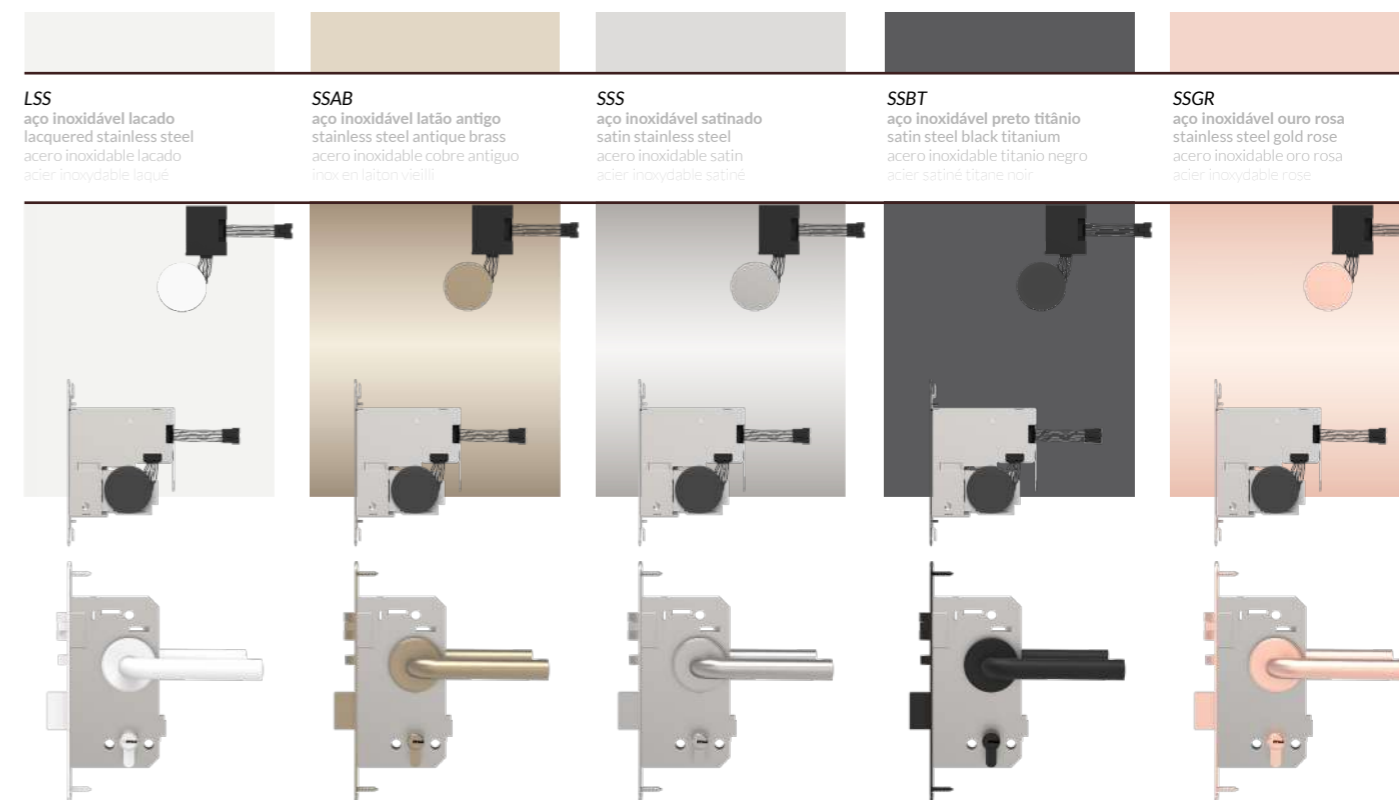

Euro Invisible®

Ficha Técnica

Datasheet

Hoja Técnica

Fiche Technique

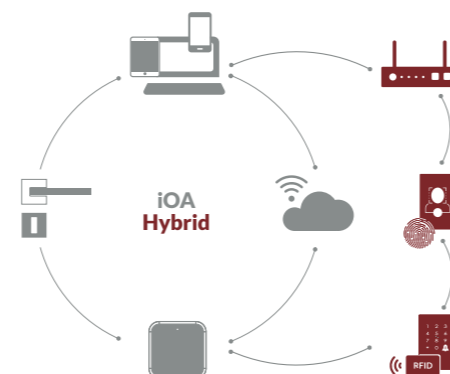

pt.		en.	
Material	Aço Inoxidável	Material	Stainless steel
Método de abertura	Cartão, Wifi, Chave Mecânica	Opening method	Card, Wifi, Mechanical Key
Tempo de identificação	<0,1 S	Identification time	<0.1 S
Comunicação	Mifare (13,56 MHz)	Communication	Mifare (13.56 MHz)
Teclado	N/A	Keyboard	N/A
Cilindro	Cilindro Europeu	Cylinder	European cylinder
Compatibilidade com fechadura	Euro Solenoide e ANSI Solenoide	Lock compatibility	Euro Solenoid and ANSI Solenoid
Energia de Emergência	Micro USB	Emergency Energy	Micro USB
Abertura de Emergência	Chave Mecânica	Emergency opening	Mechanical Key
Potência	CC 6 V (AAA * 4)	Power	DC 6 V (AAA * 4)
Potência Máxima	6V-MAX	Maximum power	6V-MAX
Vida Útil Bateria	~ 12 meses	Battery Life	~ 12 months
	Suporta ~ 5,000 operações de abertura e fecho		Supports ~5,000 operations of opening and closing
Leds	Branco	Leds	White
Alarme Bateria Fraca	3 bips	Low Battery Alarm	3 beeps
Consumo	<200 mA	Consumption	<200 mA
Consumo Estático	65µA	Static Consumption	65µA
Tempo Aberto	5s; 10s; 15s; 30s; 60s; personalizado	Open time	5s; 10s; 15s; 30s; 60s; custom
Número Aberturas	~ 5,000 aberturas (1 ano)	Number of Openings	~5,000 openings (1 year)
Software Web	iTEC OnHospitality iTEC OnAccessPRO	Web Software	iTEC OnHospitality iTEC OnAccessPRO
Software Windows	iTEC Hybrid	Windows Software	iTEC Hybrid
APP's	iTEC iOA (Opção Integração)	APP's	iTEC iOA (Integration Option)
Compatibilidade	iOS 8;	Compatability	iOS 8; Android 5; or superior
Stand Alone	N/A	Stand alone	N/A
IP	IP56	IP	IP56
Peso	1,86 Kg	Weight	1.86 kg
Resistência à Humidade	30% -95%	Moisture Resistance	30% -95%
Temp. Funcionamento	-20°C ~ + 55°C	Temp. Operation	-20°C ~ + 55°C
Nº de Código via APP	N/A	Code No. via APP	N/A
Nº de Cód. auto-definido	N/A	Self-defined Code No.	N/A
Nº de Impressão Digital	N/A	Fingerprint No.	N/A
Nº de Cartões de IC	200	No. of IC Cards	200
Níveis de Utilizadores	Sim	User Levels	Yes
Código de Gestão	Sim	Management Code	Yes
Cores Disponíveis	Aço Inox Satinado	Available Colors	Satin Stainless Steel
Instalação	Residenciais, Apartamentos, Escritórios, AIRBNB, Hotéis	Installation	Residential, Apartments, Offices, AIRBNB, Hotels
Espessura da Porta	8 mm ~ 110 mm	Door Thickness	8mm ~ 110mm

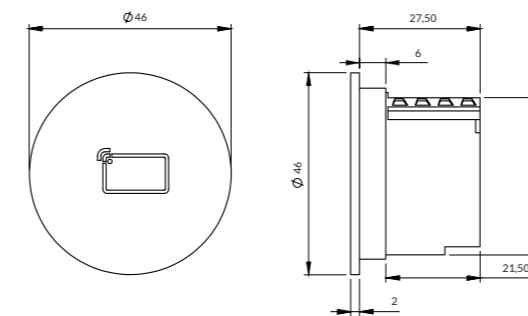

es.		fr.	
Material	Acero inoxidable	Matériel	Acier inoxydable
Método de apertura	Tarjeta, Wifi, Llave Mecánica	Méthode d'ouverture	Carte, Wifi, Clé Mécanique
Tiempo de identificación	<0,1 segundos	Temps d'identification	<0,1 S
Comunicación	Mifare (13,56 MHz)	La communication	Mifare (13,56 MHz)
Teclado	N/A	Clavier	N/A
Cilindro	Cilindro europeo	Cylindre	Cylindre européen
Compatibilidad de bloqueo	Solenoide Euro y Solenoide ANSI	Compatibilité serrure	Solenoïde Euro et solenoïde ANSI
Energía de emergencia	Micro USB	Énergie d'urgence	Micro USB
Apertura de emergencia	llave mecanica	Ouverture d'urgence	Clé mécanique
Energía	CC 6 V (AAA * 4)	Pouvoir	CC 6 V (AAA * 4)
Poder maximo	6V-MAX	Puissance maximum	6V-MAX
Duración de la batería	~ 12 meses	Vie de la batterie	~ 12 mois
	Soporta ~5,000 operaciones de abriendo y cerrando		Prend en charge ~ 5 000 opérations de ouverture et fermeture
LED	Blanco	LED	Blanc
Alarma de batería baja	3 pitidos	Alarme de batterie faible	3 bips
Consumo	<200mA	Consommation	<200mA
Consumo estático	65µA	Consommation statique	65µA
Tiempo abierto	5s; 10s; 15 s; 30 años; años 60; personalizado	Heure d'ouverture	5s ; 10s ; 15s ; 30s ; années 60 ; Douane
Número de aperturas	~5.000 vacantes (1 año)	Nombre d'ouvertures	~5 000 ouvertures (1 an)
Softwate Web	iTEC OnHospitality iTEC OnAccessPRO	Logiciel Web	iTEC OnHospitality iTEC OnAccessPRO
Software de Windows	iTEC Hybrid	Logiciel Windows	iTEC Hybrid
Aplicaciones	iTEC iOA (Opción de Integración)	Applications	iTEC iOA (Possibilité d'intégration)
Compatibilidad	iOS 8; androide 5; o superior	Compatibilité	iOS 8 ; Android 5 ; ou supérieur
Ser único	N/A	Autonome	N/A
IP	IP56	IP	IP56
Peso	1,86 kg	Poids	1,86 kg
Resistencia a la humedad	30% -95%	Résistance à l'humidité	30% -95%
Temperatura. Operación	-20°C ~ + 55°C	Temp. Opération	-20°C ~ + 55°C
Número de código a través de la aplicación	N/A	Nº de code via APP	N/A
Número de código auto-definido	N/A	Nº de code auto-défini	N/A
Nº de huella dactilar	N/A	Nº d'empreintes digitales	N/A
Número de tarjetas IC	200	Nombre de cartes IC	200
Niveles de usuario	Sí	Niveaux d'utilisateur	Oui
Código de gestión	Sí	Code de gestion	Oui
Colores disponibles	Acero inoxidable satinado.	Couleurs disponibles	Acier inoxydable satiné
Instalación	Residencial, Apartamentos, Oficinas, AIRBNB, Hoteles	Installation	Résidentiel, Appartements, Bureaux, AIRBNB, Hôtels
Grosor de la puerta	8 mm ~ 110 mm	Épaisseur de la porte	8mm ~ 110mm

ANSI Invisible®

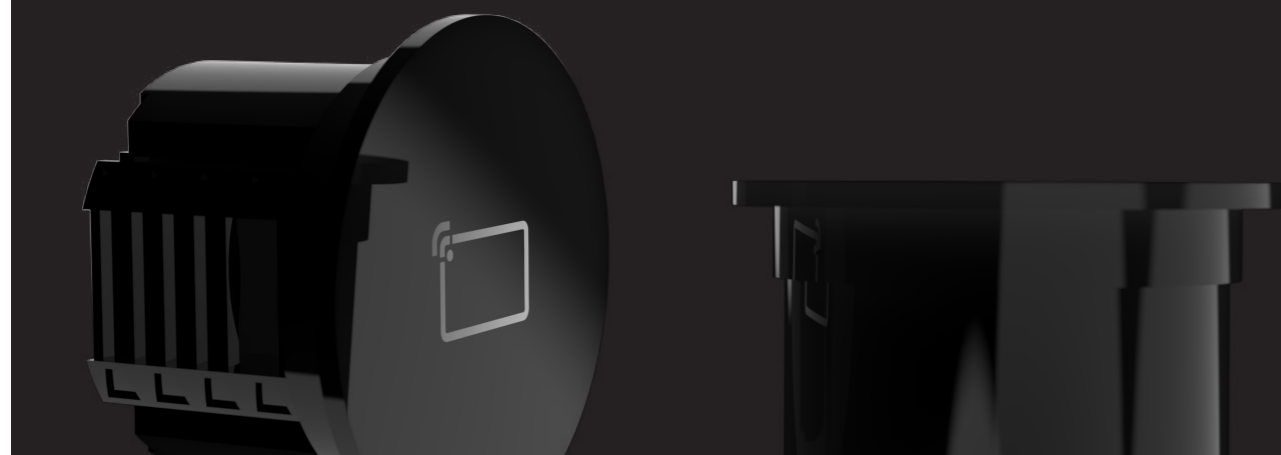

- AIA
- RFID
- 3x
- IP64

pt. A fechadura ANSI Invisible, um pack conjunto, confere um visual minimalista ao processo de abertura por cartão RFID (Mifare), através de um design elegante, prezado pela simplicidade estética em contexto de uso. Possibilita também a abertura manual além cartão e é compatível com o aplicativo iTEC Hybrid.

en. The Invisible ANSI Lock, an pack, provide a minimalist look to the RFID card (Mifare) opening process, through an elegant design that cares about aesthetic simplicity at the moment of use. It also has the option of manual opening in addition to the card and is compatible with iTEC Hybrid.

es. El ANSI Lock Invisible, un pack, aporta un aspecto minimalista al proceso de apertura de la tarjeta RFID (Mifare), a través de un diseño elegante que se preocupa por la simplicidad estética en el momento de su uso. También tiene la opción de apertura manual adicional a la tarjeta y es compatible con la aplicación iTEC Hybrid.

fr. L'Invisible ANSI Lock, un pack, donne un aspect minimaliste au processus d'ouverture de la carte RFID (Mifare), grâce à un design élégant qui se soucie de la simplicité esthétique au moment de l'utilisation. Il a également la possibilité d'une ouverture manuelle en complément de la carte et est compatible avec l'application iTEC Hybrid.

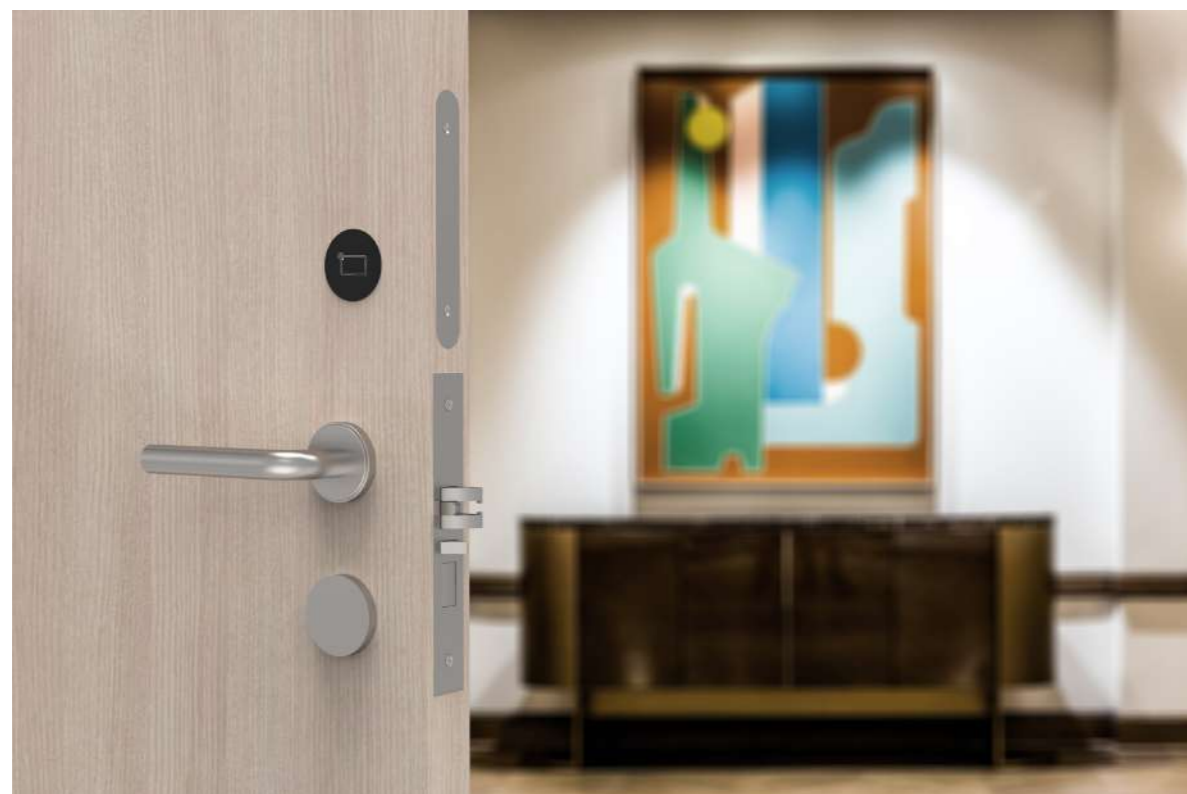

- iTEC Access
- iTEC Access pro
- HY hybrid

pt. Cores e puxadores disponíveis por pedido
en. Colors and handle available on request

es. Colores y manillas disponibles bajo pedido
fr. Couleurs et poignées disponibles sur demande



LSS aço inoxidável lacado lacquered stainless steel acero inoxidable lacado acier inoxydable laqué	SSAB aço inoxidável latão antigo stainless steel antique brass acero inoxidable cobre antiguo inox en laiton vieilli	SSS aço inoxidável satinado satin stainless steel acero inoxidable satin acier inoxydable satiné	SSBT aço inoxidável preto titânio satin steel black titanium acero inoxidable titanio negro acier satiné titane noir	SSGR aço inoxidável ouro rosa stainless steel gold rose acero inoxidable oro rosa acier inoxydable rose
---	---	---	---	--

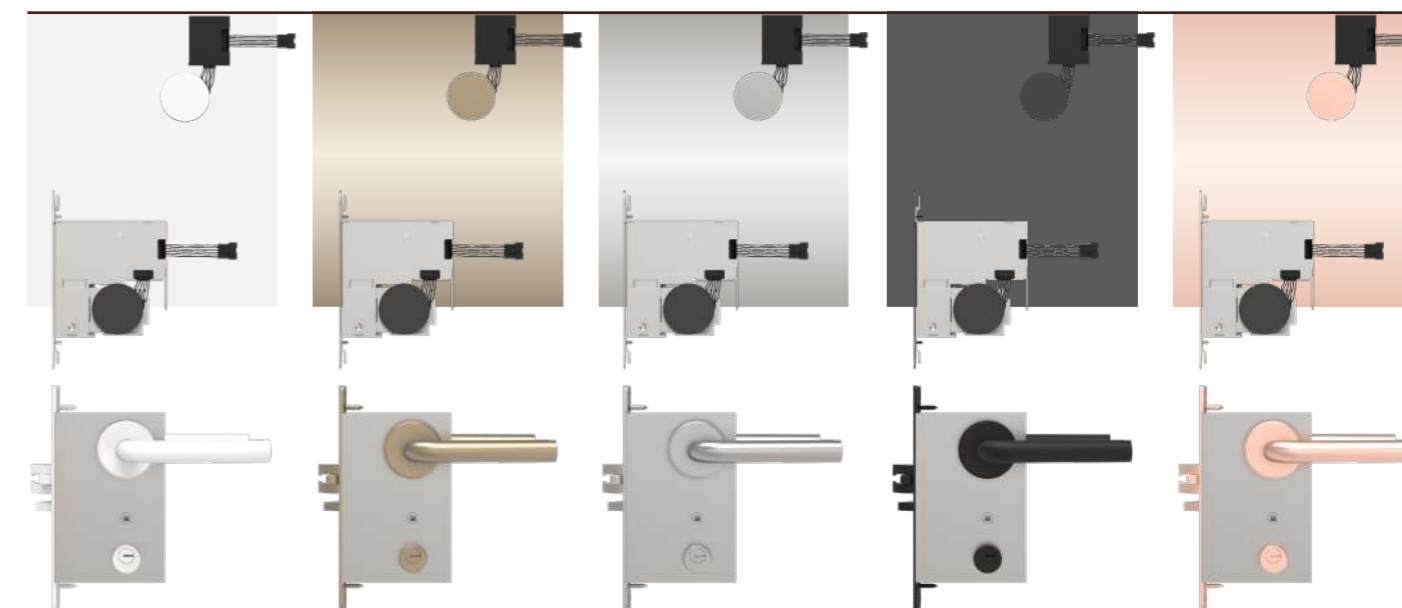

ANSI Invisible®

Ficha Técnica

Datasheet

Hoja Técnica

Fiche Technique

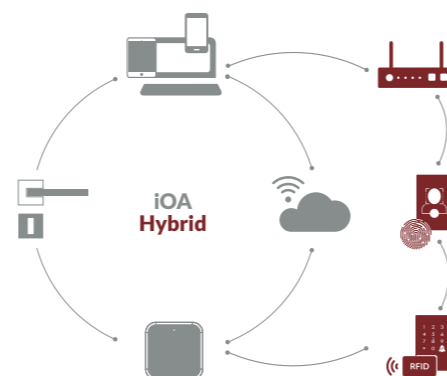

pt.		en.	
Material	Aço Inoxidável	Material	Stainless steel
Método de abertura	Cartão, Wifi, Chave Mecânica	Opening method	Card, Wifi, Mechanical Key
Tempo de identificação	<0,1 S	Identification time	<0.1 S
Comunicação	Mifare (13,56 MHz)	Communication	Mifare (13.56 MHz)
Teclado	N/A	Keyboard	N/A
Cilindro	Cilindro ANSI	Cylinder	ANSI Cylinder
Compatibilidade com fechadura	Euro Solenoide e ANSI Solenoide	Lock compatibility	Euro Solenoid and ANSI Solenoid
Energia de Emergência	Micro USB	Emergency Energy	Micro USB
Abertura de Emergência	Chave Mecânica	Emergency opening	Mechanical Key
Potência	CC 6 V (AAA * 4)	Power	DC 6 V (AAA * 4)
Potência Máxima	6V-MAX	Maximum power	6V-MAX
Vida Útil Bateria	~ 12 meses	Battery Life	~ 12 months
	Suporta ~ 5,000 operações de abertura e fecho		Supports ~5,000 operations of opening and closing
Leds	Branco	Leds	White
Alarme Bateria Fraca	3 bips	Low Battery Alarm	3 beeps
Consumo	<200 mA	Consumption	<200 mA
Consumo Estático	65µA	Static Consumption	65µA
Tempo Aberto	5s; 10s; 15s; 30s; 60s; personalizado	Open time	5s; 10s; 15s; 30s; 60s; custom
Número Aberturas	~ 5,000 aberturas (1 ano)	Number of Openings	~5,000 openings (1 year)
Software Web	iTEC OnHospitality iTEC OnAccessPRO	Web Software	iTEC OnHospitality iTEC OnAccessPRO
Software Windows	iTEC Hybrid	Windows Software	iTEC Hybrid
APP's	iTEC iOA (Opção Integração)	APP's	iTEC iOA (Integration Option)
Compatibilidade	iOS 8;	Compatability	iOS 8; Android 5; or superior
Stand Alone	N/A	Stand alone	N/A
IP	IP56	IP	IP56
Peso	1,86 Kg	Weight	1.86 kg
Resistência à Humidade	30% -95%	Moisture Resistance	30% -95%
Temp. Funcionamento	-20°C ~ + 55°C	Temp. Operation	-20°C ~ + 55°C
Nº de Código via APP	N/A	Code No. via APP	N/A
Nº de Cód. auto-definido	N/A	Self-defined Code No.	N/A
Nº de Impressão Digital	N/A	Fingerprint No.	N/A
Nº de Cartões de IC	200	No. of IC Cards	200
Níveis de Utilizadores	Sim	User Levels	Yes
Código de Gestão	Sim	Management Code	Yes
Coors Disponíveis	Aço Inox Satinado	Available Colors	Satin Stainless Steel
Instalação	Residenciais, Apartamentos, Escritórios, AIRBNB, Hotéis	Installation	Residential, Apartments, Offices, AIRBNB, Hotels
Espessura da Porta	8 mm ~ 110 mm	Door Thickness	8mm ~ 110mm

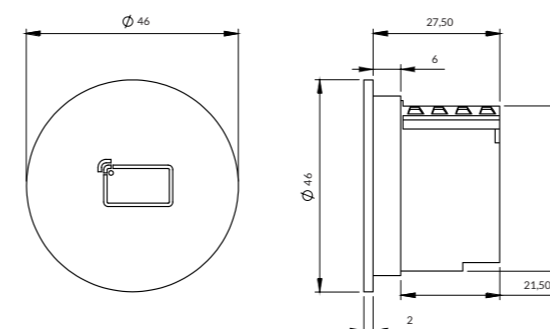

es.		fr.	
Material	Acero inoxidable	Matériel	Acier inoxydable
Método de apertura	Tarjeta, Wifi, Llave Mecánica	Méthode d'ouverture	Carte, Wifi, Clé Mécanique
Tiempo de identificación	<0,1 segundos	Temps d'identification	<0,1 S
Comunicación	Mifare (13,56 MHz)	La communication	Mifare (13,56 MHz)
Teclado	N/A	Clavier	N/A
Cilindro	Cilindro ANSI	Cylindre	Cylindre ANSI
Compatibilidad de bloqueo	Solenoide Euro y Solenoide ANSI	Compatibilité serrure	Solenoïde Euro et solenoïde ANSI
Energía de emergencia	Micro USB	Énergie d'urgence	Micro USB
Apertura de emergencia	llave mecanica	Ouverture d'urgence	Clé mécanique
Energía	CC 6 V (AAA * 4)	Pouvoir	CC 6 V (AAA * 4)
Poder maximo	6V-MAX	Puissance maximum	6V-MAX
Duración de la batería	~ 12 meses	Vie de la batterie	~ 12 mois
	Soporta ~5,000 operaciones de abriendo y cerrando		Prend en charge ~ 5 000 opérations de ouverture et fermeture
LED	Blanco	LED	Blanc
Alarma de batería baja	3 pitidos	Alarme de batterie faible	3 bips
Consumo	<200mA	Consommation	<200mA
Consumo estático	65µA	Consommation statique	65µA
Tiempo abierto	5s; 10s; 15 s; 30 años; años 60; personalizado	Heure d'ouverture	5s ; 10s ; 15s ; 30s ; années 60 ; Douane
Número de aperturas	~5.000 vacantes (1 año)	Nombre d'ouvertures	~5 000 ouvertures (1 an)
Softwate Web	iTEC OnHospitality iTEC OnAccessPRO	Logiciel Web	iTEC OnHospitality iTEC OnAccessPRO
Software de Windows	iTEC Hybrid	Logiciel Windows	iTEC Hybrid
Aplicaciones	iTEC iOA (Opción de Integración)	Applications	iTEC iOA (Possibilité d'intégration)
Compatibilidad	iOS 8; androide 5; o superior	Compatibilité	iOS 8 ; Android 5 ; ou supérieur
Ser único	N/A	Autonome	N/A
IP	IP56	IP	IP56
Peso	1,86 kg	Poids	1,86 kg
Resistencia a la humedad	30% -95%	Résistance à l'humidité	30% -95%
Temperatura. Operación	-20°C ~ + 55°C	Temp. Opération	-20°C ~ + 55°C
Número de código a través de la aplicación	N/A	Nº de code via APP	N/A
Número de código auto-definido	N/A	Nº de code auto-défini	N/A
Nº de huella dactilar	N/A	Nº d'empreintes digitales	N/A
Número de tarjetas IC	200	Nombre de cartes IC	200
Niveles de usuario	Sí	Niveaux d'utilisateur	Oui
Código de gestión	Sí	Code de gestion	Oui
Colores disponibles	Acero inoxidable satinado.	Couleurs disponibles	Acier inoxydable satiné
Instalación	Residencial, Apartamentos, Oficinas, AIRBNB, Hoteles	Installation	Résidentiel, Appartements, Bureaux, AIRBNB, Hôtels
Grosor de la puerta	8 mm ~ 110 mm	Épaisseur de la porte	8mm ~ 110mm



iCode ECO®

SSS



4x
AAA

CE

IP64

pt. A iCode ECO é uma fechadura muito robusta que torna o seu arrombamento praticamente impossível dada à sua construção. Funciona através de código PIN. Tem entrada oculta para chave mecânica. Este modelo é compatível com as nossas aplicações iTEC OnAccess, que lhe permite uma abertura por bluetooth e uma gestão remota.

en. The iCode ECO is a very robust lock that makes it practically impossible to break due to its construction. Works via PIN code. It has hidden entrance for mechanical key. This model is compatible with our iTEC OnAccess applications, which allows Bluetooth opening and remote management.

es. iCode ECO es una cerradura muy robusta que hace que sea prácticamente imposible de romper debido a su construcción. Funciona a través del código PIN. Tiene entrada oculta para llave mecánica. Este modelo es compatible con nuestras aplicaciones iTEC OnAccess, que permiten la apertura y administración remota de Bluetooth.

fr. L'iCode ECO est une serrure très robuste qui la rend pratiquement impossible à casser en raison de sa construction. Fonctionne via le code PIN. Il a une entrée cachée pour la clé mécanique. Ce modèle est compatible avec nos applications iTEC OnAccess, qui permettent l'ouverture Bluetooth et la gestion à distance.

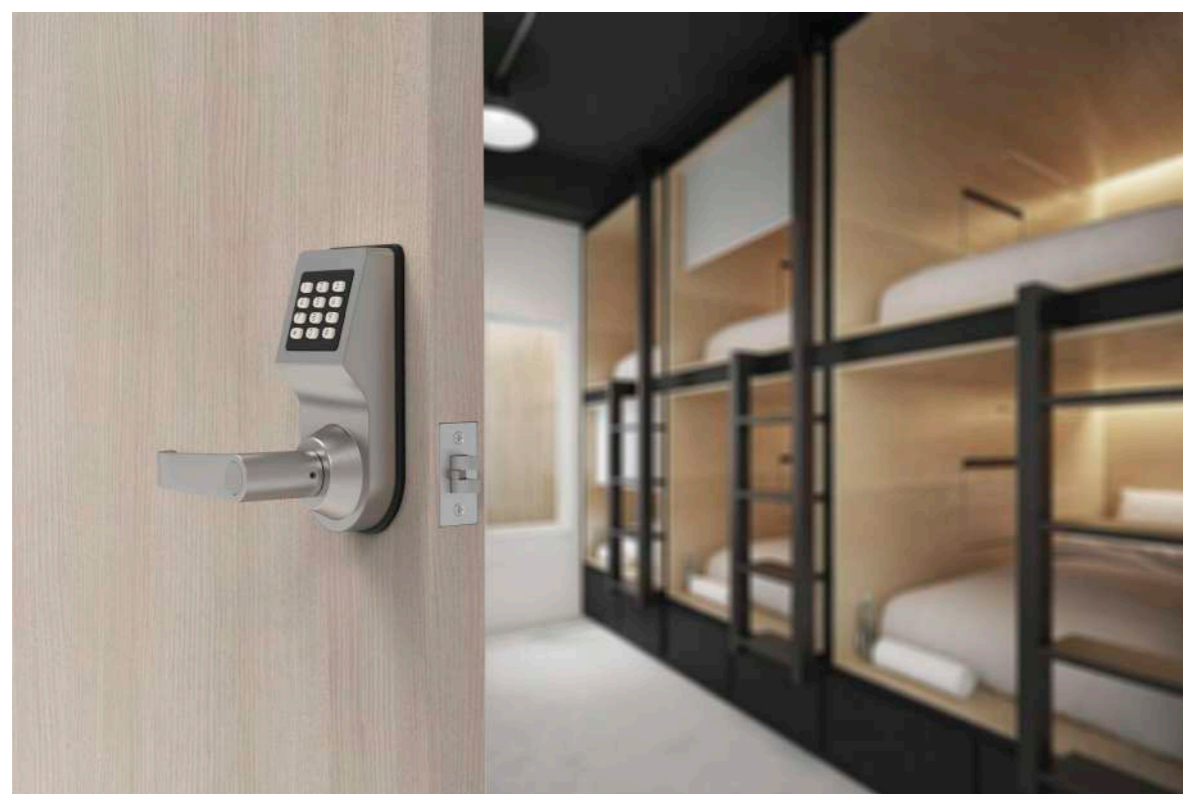

iCode ECO®

Ficha Técnica

Datasheet

Hoja Técnica

Fiche Technique

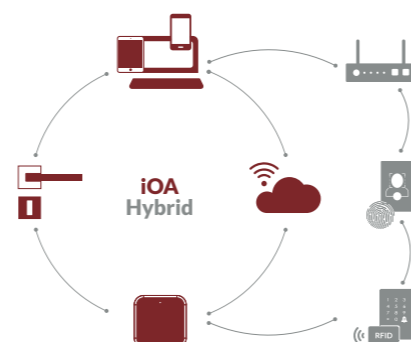

pt.

Material	Liga Metálica
Método de Abertura	Código , Cartão, Wifi, BLE, APP, Chave Mecânica
Tempo de Identificação	<0.1S
Comunicação	Bluetooth 4.1; Mifare (13,56MHz)
Teclado Toque	Sim
Cilindro	Cilindro Europeu
Compatibilidade com fechaduras	Trinco silencioso iTSL01
Energia de Emergência	Micro USB
Abertura de Emergência	Chave Mecânica
Potência	DC 6v (AA*4)
Máx. Potência	6V-MAX
Vida Útil da Bateria	~12 meses
	Suporta ~ 5,000 Operações de Abertura & Fecho
Leds	Branco e Azul
Alarme de Bateria Fraca	Na APP e Alarme por voz,
Consumo	<200mA
Consumo Estático	65µA
Tempo Aberto	5s; 10s; 15s; 30s; 60s; personalizado
Número de Aberturas	~5,000 Aberturas (1Ano)
Software Web	iTEC OnHospitality iTEC OnAccessPRO
Software Windows	iTEC Hybrid
APP's	iTEC iOA
Compatibilidade	IOS 8; Android 5; e superior
Stand Alone	Sim
IP	IP55
Peso	2,10 Kg
Resistencia à Humidade	30%-95%
Temp. de Funcionamento	-20°C~+55°C
Nº de Código via APP	Ilimitado
Nº de Cód. auto-definido	150
Nº de Impressão Digital	N/A
Nº do cartões de IC	200
Níveis de Usuários	Sim
Código de Gestão	Sim
Cores Disponíveis	Satinado
Instalação	Apartamentos, Residenciais, Escritórios, AIRBNB, Hotéis
Espessura de porta	30mm~55mm

en.

Material	AlZinc Alloy
Opening Method	Code, Card, Wifi, BLE, APP, Mechanical Key
Identification Time	<0.1S
Communication	Bluetooth 4.1 Mifare (13,56MHz)
Keypad	Yes
Cylinder Type	Own
Compatibility with locks	ITSL latch
Emergency Power	Micro USB
Emergency Opening	Mechanical Key
Voltage	DC 6v (AA*4)
Max. Power	6V-MAX
Battery Life	~ 12 months
	Supports ~ 5,000 Opening & Closing Operations
Leds	White ; Blue
Low Battery Alarm	In the APP and Voice Alarm
	Below 4,8V
Consumption	<200mA
Static Consumption	65µA
Time Open	14s; 10s; 15S; 30s; 60s; custom
Number of Openings	~5,000 Openings (1Year)
Web Software	iTEC OnHospitality iTEC OnAccessPRO
Windows Software	iTEC Hybrid
APP's	iTEC iOA
Compatability	IOS 8; Android 5; or earlier
Stand Alone	Yes
IP	IP55
Weight	2,10 Kg
Humidity Resistance	30%-95%
Temp. of Operation	-20°C~+55°C
Code No. via APP	Unlimited
Self-defined Code No.	150
Fingerprint Number	N/A
IC card number	200
User Levels	Yes
Management Code	Yes
Available Colors	Nickel Satin
Installation	Residences, Apartments, Hostels, Offices, AIRBNB, Hotels
Door thickness	30mm~55mm

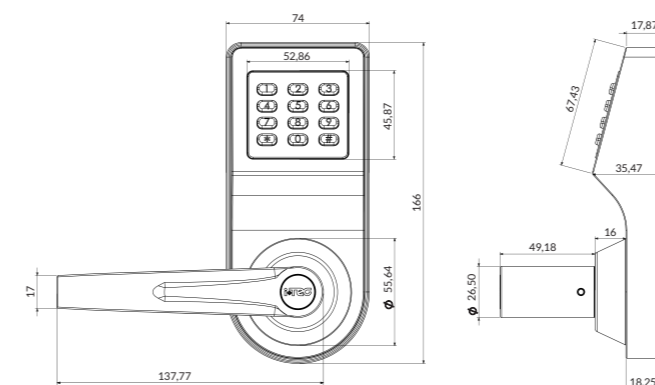

es.

Material	Aleación
Método de apertura	Código, Tarjeta, Wifi, BLE, APP, Llave mecánica
Tiempo de identificación	<0,1 S
Comunicación	Bluetooth 4.1; Mifare (13,56 MHz)
Teclado	Sí
Bombillo	Propio
Tipo de cerraduras	Pestillo ITSL
Voltaje	Micro USB
Apertura de emergencia	Llave mecánica
Duración de la batería	CC 6 V (AA * 4)
Energía máxima	6V-MAX
Duración de la Bateria	~ 12 meses
	Admite ~ 5,000 operaciones de apertura y cierre
Leds	Blanco ; Azul
Alarma de batería baja	En la aplicación y alarma por voz Por debajo de 4,8 V
Consumo	<200 mA
Consumo estático	65µA
Tiempo Aberto	5s; 10s; 15s; 30s; 60s;
Numero de aperturas	~ 5,000 aperturas (1 año)
Software de Windows	iTEC Hybrid iTEC iOA iTEC iOA PRO
APP's	IOS 8 o superior Android 5 o superior
Stand Alone	Sí
IP	IP55
Peso	2,10 kilogramos
Resistencia a la humedad	30% -95%
Temperatura. de operación	-20°C ~ + 55°C
No. de código via APP	Ilimitado
No. Código autodefinido	150
Número de huella digital	N/A
Número de tarjeta IC	200
Niveles de usuario	Sí
Código de gestión	Sí
Colores disponibles	Níquel satinado
Instalación	Residencias, Apartamentos, Hostales, Oficinas, AIRBNB, Hoteles
Espesor de puerta	30 mm ~ 55 mm

fr.

Matériel	Alliage
Méthode d'ouverture	Code, carte, Wifi, BLE, APP, clé mécanique
Temps d'identification	<0,1 S
Communication	Bluetooth 4.1 Mifare (13,56 MHz)
Clavier	Oui
Compatibilité avec les serrures	Propre Loquet ITSL
Ouverture d'urgence	Micro USB
Alimentation de secours	Clé mécanique
Max. Puissance	DC 6 v (AA * 4)
Vie de la batterie	6V-MAX
Max. Puissance	~ 12 mois
Vie de la batterie	Prend en charge environ 5000 opérations d'ouverture et de fermeture
Leds	Blanc; Bleu
Alarme de batterie faible	Dans l'application et l'alarme vocale En dessous de 4,8V
Consommation statique	<200 mA
Consommation	65µA
Temps ouvert	14s; 10s; 15S; 30s; 60s; Douane
Nombre d'ouvertures	~ 5000 ouvertures (1 an)
Logiciel Windows	iTEC Hybrid iTEC iOA iTEC iOA PRO
App's	IOS 8 ou supérieur Android 5 ou supérieur
Autonome	Oui
IP	IP55
Poids	2,10 kilogrammes
Résistance à l'humidité	30%-95%
Temp. De fonctionnement	-20 ° C à + 55 ° C
N ° de code via APP	Illimité
N ° de code auto-défini	150
Numéro d'empreinte digitale	N/A
Numéro de carte IC	200
Niveaux d'utilisateurs	Oui
Code de gestion	Oui
Couleurs disponibles	Nickel satiné
Installation	Résidences, appartements, auberges, bureaux, AIRBNB, hôtels
Épaisseur de la porte	30 mm à 55 mm



iHandle 03P®

- GLS
- ZZA
- Hand icon
- Bluetooth icon
- Key icon
- 4x AAA
- CE
- IP44

pt. O novo modelo iHandle 03P é um puxador eletrónico universalmente aplicável a qualquer tipo de porta com um sensor electrónico que funciona por proximidade e remotamente através da APP. A tecnologia de comunicação, mecatrónica e baterias estão localizados no interior do seu corpo metálico.

en. The new iHandle 03P is a universally applicable electronic handle with an electronic proximity sensor and remotely through the APP. Communication technology, mechatronics and batteries are located inside your metal body.

es. El nuevo modelo iHandle 03P es una manilla electrónica de aplicación universal con un sensor electrónico que actúa por la proximidad y remotamente a través de la APP. comunicación, mecatrónica y tecnología de las baterías se encuentran dentro de su cuerpo de metal.

fr. Le nouveau modèle iHandle 03P est une poignée électronique universellement applicable avec un capteur électronique qui agit par la proximité et à distance via l'APP. Communication technologie, de la mécatronique et les batteries sont situées à l'intérieur de son corps métallique.

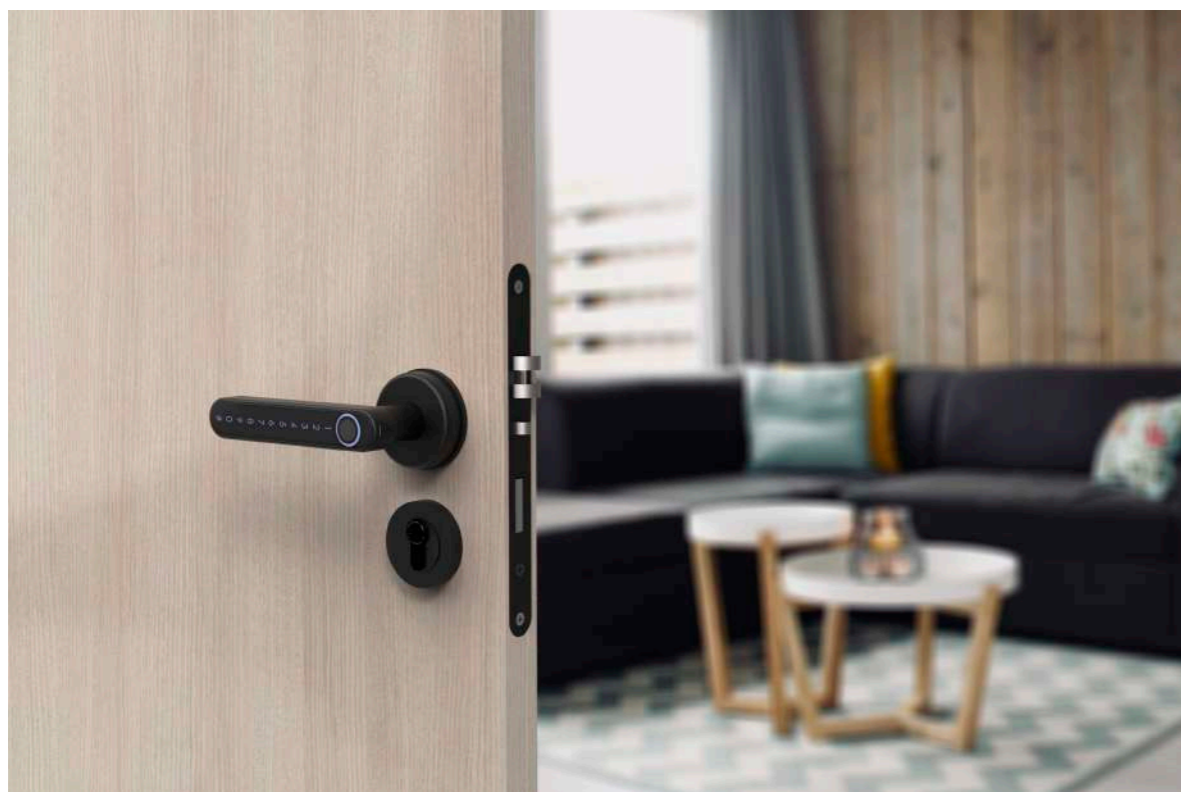

pt. Método de Abertura
en. Opening Method

es. Método de Apertura
fr. Méthode D'ouverture



- HU hybrid
- itec Access
- itec Access pro

iHandle 03P[®]

Ficha Técnica

Datasheet

Hoja Técnica

Fiche Technique

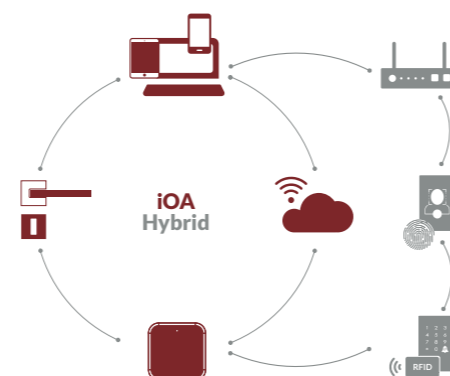

pt.

Material	Liga Metálica + Vidro
Método de Abertura	Impressão Digital, Código, Wifi, BLE, APP, Chave Mecânica
Tempo de Identificação	<0.5S
Comunicação	Bluetooth 4.1
Cilindro	N/A
Compatibilidade com fechaduras	Standard 8mm
Energia de Emergência	Micro USB
Abertura de Emergência	Chave Mecânica
Potência	DC 6v (AAA*4)
Máx. Potência	6V-MAX
Vida Útil da Bateria	~12 meses
Leds	Branco; Vermelho; Azul
Alarme de Bateria Fraca	Na APP. Abaixo de 4,5V
Consumo	<150mA
Consumo Estático	15µA
Tempo Aberto	5s; 10s; 15s; 30s; 60s; personalizado
Número de Aberturas	~5,000 Aberturas (1Ano)
Software Web	iTEC OnHospitality iTEC OnAccessPRO
Software Windows	iTEC Hybrid
APP's	iTEC iOA
Compatibilidade	IOS 8; Android 5; e superior
Stand Alone	N/A
IP	IP55
Peso	1,20 Kg
Resistencia à Humidade	30%-95%
Temp. de Funcionamento	-20°C~+55°C
Nº de Código via APP	Ilimitado
Nº de Cód. auto-definido	150
Nº de Impressão Digital	150
Nº do cartões de IC	N/A
Níveis de Usuários	Sim
Código de Gestão	Sim
Cores Disponíveis	Negro; Cinza
Instalação	Residencias, Apartamentos, Residenciais, Escritórios, AIRBNB, Hotéis
Espeçura de porta	30mm~110mm

en.

Material	Alloy Metal + Glass
Opening Method	Fingerprint, Code, Wifi, BLE, APP, Mechanical Key
Identification time	<0.5S
Communication	Bluetooth 4.1
Cylinder	N/A
Compatibility with locks	Standard 8mm
Emergency Energy	Micro USB
Emergency opening power	Mechanical Wrench
Max. Power	DC 6v (AAA*4)
Battery Life	~12 months
Leds	White; Red; Blue
Low Battery Alarm	In the APP
Consumption	<150mA
Static Consumption	15µA
Open time	5s; 10s; 15s; 30s; 60s; custom
Number of Openings	~5,000 Openings (1 Year)
Web Software	iTEC OnHospitality iTEC OnAccessPRO
Windows Software	iTEC Hybrid
APP's	iTEC iOA
Compatibility	IOS 8; Android 5;
Stand alone	N/A
IP	IP55
Weight	1.20 kg
Moisture Resistance	30%-95%
Temp. of Operation	-20°C~+55°C
Code No. via APP	Unlimited
Self-defined Code No.	150
Fingerprint No.	150
IC card no.	AT
User Levels	Yea
Management Code	Yea
Available Colors	Black; Gray
Installation	Residences, Apartments, Residences, Offices, AIRBNB, Hotels
Door thickness	30mm~110mm

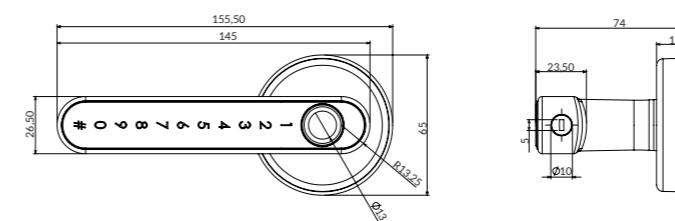

es.

Material	Aleación + Vidrio
Método de apertura	Huella digital, Código, Wifi, BLE, App, Llave mecánica
Tiempo de identificación	<0.5S
Comunicación	Bluetooth 4.1
Cilindro	N/A
Compatibilidad cerraduras	Estándar 8mm
Energía de emergencia	Micro USB
Apertura de emergencia	Llave mecánica
Energía	CC 6 V (AAA * 4)
Máx. Energía	6V-MAX
Duración de la batería	~ 12 meses
Leds	Blanco; Rojo; Azul;
Alarma de batería baja	En la aplicación y alarma por voz
Consumo	< 150 mA
Consumo estático	15µA
Tiempo abierto	5s; 10s; 15s; 30s; 60s; personalizado
Número de aperturas	~ 5,000 aperturas (1 año)
Software Web	iTEC OnHospitality iTEC OnAccessPRO
Software de Windows	iTEC Hybrid
Aplicaciones	iTEC iOA
Compatibilidad	IOS 8; Android 5; o superior
Ser único	N/A
IP	IP55
Peso	1,20 kilogramos
Resistencia a la humedad	30% -95%
Temperatura. de operación	-20°C ~ + 55°C
Número de código a través de la aplicación	Ilimitado
Número de código auto-definido	150
Nº de huella dactilar	150
Número de tarjeta IC	N/A
Niveles de usuario	Sí
Código de gestión	Sí
Colores disponibles	Negro
Instalación	Residencias, Apartamentos, Hostales, Oficinas, AIRBNB, Hoteles
Grosor de la puerta	30 mm ~ 110 mm

fr.

Matériel	Alliage + Verre
Méthode d'ouverture	Empreinte digitale, Code, Wifi, BLE, App, Clé mécanique
Tiempo d'identification	<0.5S
Communication	Bluetooth 4.1
Cilindro	N/A
Compatibilidad cerraduras	Norme 8mm
Énergie d'urgence	Micro USB
Ouverture d'urgence	Clé à molette
Énergie	CC 6 V (AAA * 4)
Max. Énergie	6V-MAX
Durée de la batterie	~ 12 mois
LED	Blanc ; Rouge; Bleu
Alarme de batterie basse	Dans l'application et l'alarme vocale
Consommation	<150mA
Consommation esthétique	15µA
Tiempo ouvert	5s ; 10s ; 15s ; 30s ; années 60 ; personnalisé
Nombre d'ouvertures	~5 000 ouvertures (1 an)
Logiciel Web	iTEC OnHospitality iTEC OnAccessPRO
Logiciel Windows	iTEC Hybrid
Applications	iTEC iOA
Compatibilité	iOS 8; Android 5; ou supérieur
Ser único	N/A
IP	IP55
Peso	1,20 kilogrammes
Résistance à la humedad	30%-95%
Température. de fonctionnement	-20°C ~ +55°C
Número de código a través de la aplicación	Illimité
Numéro de code défini automatiquement	150
Nº de huella dactilar	150
Numéro de cible IC	N/A
Niveles de l'utilisateur	Oui
Code de gestion	Oui
Couleurs disponibles	Noir
Installation	Résidences, Appartements, Auberges, Bureaux, AIRBNB, Hôtels
Grosor de la porte	30mm~110mm

iCylinder 07[®]



SSS



1x
C36

IP64

pt. Fácil de instalar, não requer perfuração nem trabalho de carpintaria. Desbloqueia através de dispositivo móvel, por código PIN, cartão RFID ou uma chave mecânica de emergência. Sistema com gateway e APP para gerar chaves remotamente e poder enviar para qualquer lugar do mundo.

en. Easy to install, requires no drilling or carpentry work. Unlocks via mobile device, PIN code, RFID card or mechanical emergency key. System with gateway and APP to generate keys remotely and send to anywhere in the world.

es. Fácil de instalar, no requiere perforación y sin trabajo de carpintería. Desbloquee a través de un dispositivo móvil, por código PIN, tarjeta RFID o una llave mecánica de emergencia. Sistema con puerta de enlace y APP para generar claves remotamente y poder enviar a cualquier lugar del mundo.

fr. Facile à installer, ne nécessite aucun travail de forage ou de menuiserie. Déverrouille via un appareil mobile, un code PIN, une carte RFID ou une clé d'urgence mécanique. Système avec passerelle et application permettant de générer des clés à distance et de les envoyer partout dans le monde.



iCylinder 07[®]

Ficha Técnica

Datasheet

Hoja Técnica

Fiche Technique

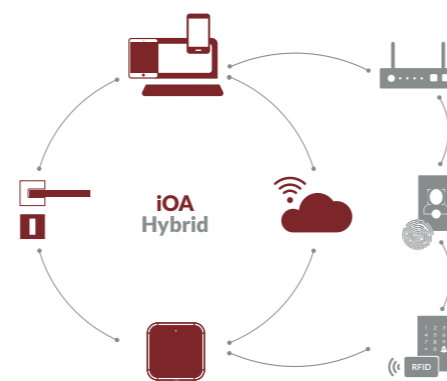

pt.

Material	Liga metálica, Inox, Vidro
Método de Abertura	Código, Cartão, Wifi, BLE, APP, Chave Mecânica
Tempo de Identificação	<0.1S
Comunicação	Bluetooth 4.1 Mifare (13,56MHz)
Cilindro	Cilindro Europeu
Compatibilidade com fechaduras	Standard Europeu
Energia de Emergência	Micro USB
Abertura de Emergência	Chave Mecânica
Potência	N/A
Máx. Potência	N/A
Vida Útil da Bateria	~12 meses Suporta 5,000 Operações de Abertura & Fecho
Leds	Azul
Alarme de Bateria Fraca	Na APP e Alarme por voz
Consumo	N/A
Consumo Estático	N/A
Tempo Aberto	5s; 10s; 15s; 30s; 60s; personalizado
Número de Aberturas	~5,000 Aberturas (1Ano)
Software Web	iTEC OnHospitality iTEC OnAccessPRO
Software Windows	iTEC Hybrid
APP's	iTEC iOA
Compatibilidade Stand Alone	IOS 8; Android 5; e superior
IP	IP56
Peso	0,70 Kgs
Resistencia à Humidade	30%-95%
Temp. de Funcionamento	-20°C~+55°C
Nº de Código via APP	Ilimitado
Nº de Cód. auto-definido	150
Nº de Impressão Digital	N/A
Nº do cartões de IC	200
Níveis de Usuários	Sim
Código de Gestão	Sim
Cores Disponíveis	Nickel Satin, Dourado, Negro, etc.
Instalação	Residências, Apartamentos, Residenciais, Escritórios, AIRBNB, Hotéis
Espessura de porta	30mm~110mm

en.

Material	Metal alloy, Stainless steel, Glass
Opening Method	Code, Card, Wifi, BLE, APP, Mechanical Key
Identification Time	<0.1S
Communication	Bluetooth 4.1 Mifare (13,56MHz)
Cylinder	European Cylinder type
Compatibility with locks	European Standard de 70mm a 92mm
Emergency Power	Micro USB
Emergency Opening	Mechanical Key
Voltage	N/A
Max. Power	N/A
Battery Life	~12 months Supports 5000 Opening & Closing Operations
Leds	Blue
Low Battery Alarm	In the APP and Voice Alarm
Consumption	N/A
Static Consumption	N/A
Time Open	5s; 10s; 15s; 30s; 60s; personalizado
Number of Openings	~5,000 Openings (1Year)
Web Software	iTEC OnHospitality iTEC OnAccessPRO
Windows Software	iTEC Hybrid
APP's	iTEC iOA
Compatibility Stand Alone	IOS 8; Android 5; or previous
IP	IP56
Weight	0,70 Kgs
Humidity Resistance	30%-95%
Temp. of Operation	-20°C~+55°C
Code No. via APP	Unlimited
Self-defined Code No.	150
Fingerprint Number	N/A
IC card number	200
User Levels	Yes
Management Code	Yes
Available Colors	Satin Stainless Steel, Gold, Black
Installation	Residences, Apartments, Hostels, Offices, AIRBNB, Hotels
Door thickness	30mm~110mm

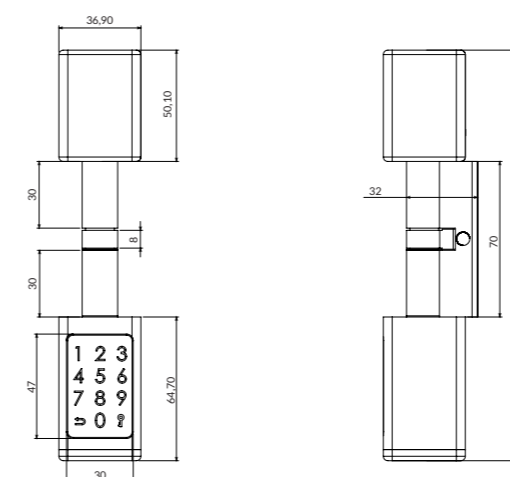

es.

Material	Aleación
Método de apertura	Código, Tarjeta, Wifi, BLE, APP, Llave mecánica
Tiempo de identificación	<0,1 S
Comunicación	Bluetooth 4.1; Mifare (13,56 MHz)
Teclado	Sí
Bombillo	Estándar Europeo
Tipo de cerraduras	Pestillo ITSL
Voltaje	Micro USB
Apertura de emergencia	Llave mecánica
Duración de la batería	CC 6 V (AA * 4)
Energía máxima	6V-MAX
Duración de la Bateria	~ 12 meses Admite ~ 5,000 operaciones de apertura y cierre
Leds	Azul
Alarma de batería baja	En la aplicación y alarma por voz Por debajo de 4,8 V
Consumo	<200 mA
Consumo estático	65µA
Tiempo Aberto	5s; 10s; 15s; 30s; 60s;
Numero de aperturas	~ 5,000 aperturas (1 año)
Software Web	iTEC OnHospitality iTEC OnAccessPRO
Software de Windows	iTEC Hybrid
Aplicaciones	iTEC iOA
Compatibilidad Stand Alone	IOS 8; Android 5; o superior
IP	IP56
Peso	2,10 kilogramos
Resistencia a la humedad	30% -95%
Temperatura. de operación	-20°C ~ + 55°C
No. de código via APP	Ilimitado
No. Código autodefinido	150
Número de huella digital	N/A
Número de tarjeta IC	200
Niveles de usuario	Sí
Código de gestión	Sí
Colores disponibles	Níquel satinado
Instalación	Residencias, Apartamentos, Hostales, Oficinas, AIRBNB, Hoteles
Espesor de puerta	30 mm ~ 55 mm

fr.

Matériel	Alliage
Méthode d'ouverture	Code, carte, Wifi, BLE, APP, clé mécanique
Temps d'identification	<0,1 S
Communication	Bluetooth 4.1 Mifare (13,56 MHz)
Cylindre	Norme Européenne
Compatibilité avec les serrures	Loquet ITSL
Ouverture d'urgence	Micro USB
Alimentation de secours	Clé mécanique
Max. Puissance	DC 6 v (AA * 4)
Vie de la batterie	6V-MAX
Max. Puissance	~ 12 mois
Vie de la batterie	Prend en charge environ 5000 opérations d'ouverture et de fermeture
Leds	Bleu
Alarme de batterie faible	Dans l'application et l'alarme vocale
Consommation statique	En dessous de 4,8V
Consommation	<200 mA
Temps ouvert	65µA
Nombre d'ouvertures	14s; 10s; 15s; 30s; 60s; Douane
Logiciel Web	~ 5000 ouvertures (1 an)
Logiciel Windows	iTEC OnHospitality iTEC OnAccessPRO
Applications	iTEC Hybrid
Compatibilité Stand Alone	iTEC iOA
Autonome	IOS 8; Android 5; supérieur
IP	Oui
Poids	IP56
Résistance à l'humidité	2,10 kilogrammes
Temp. De fonctionnement	30% -95%
N ° de code via APP	-20 ° C à + 55 ° C
N ° de code auto-défini	Ilimité
Numéro d'empreinte digitale	150
Numéro de carte IC	N/A
Niveaux d'utilisateurs	200
Code de gestion	Oui
Couleurs disponibles	Oui
Installation	Nickel satiné
Épaisseur de la porte	Residences, appartements, auberges, bureaux, AIRBNB, hôtels
	30 mm à 55 mm

iCylinder 07 ANSI®



SSS



1x
C36

CE

IP64



pt. Fácil de instalar, não requer perfuração nem trabalho de carpintaria. Desbloqueia através de dispositivo móvel, por código PIN, cartão RFID ou uma chave mecânica de emergência. Sistema com gateway e APP para gerar chaves remotamente e poder enviar para qualquer lugar do mundo.

en. Easy to install, requires no drilling or carpentry work. Unlocks via mobile device, PIN code, RFID card or mechanical emergency key. System with gateway and APP to generate keys remotely and send to anywhere in the world.

es. Fácil de instalar, no requiere perforación y sin trabajo de carpintería. Desbloquee a través de un dispositivo móvil, por código PIN, tarjeta RFID o una llave mecánica de emergencia. Sistema con puerta de enlace y APP para generar claves remotamente y poder enviar a cualquier lugar del mundo.

fr. Facile à installer, ne nécessite aucun travail de forage ou de menuiserie. Déverrouille via un appareil mobile, un code PIN, une carte RFID ou une clé d'urgence mécanique. Système avec passerelle et application permettant de générer des clés à distance et de les envoyer partout dans le monde.



iCylinder 07 ANSI®

Ficha Técnica

Datasheet

Hoja Técnica

Fiche Technique

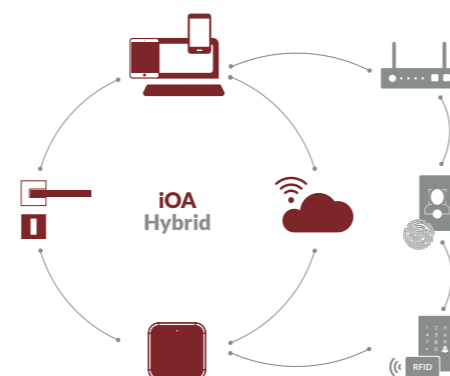

pt.

Material	Liga metálica, Inox, Vidro
Método de Abertura	Código, Cartão, Wifi, BLE, APP, Chave Mecânica
Tempo de Identificação	<0.1S
Comunicação	Bluetooth 4.1 Mifare (13,56MHz)
Cilindro	Cilindro ANSI
Compatibilidade com fechaduras	Standard ANSI
Energia de Emergência	Micro USB
Abertura de Emergência	Chave Mecânica
Potência	N/A
Máx. Potência	N/A
Vida Útil da Bateria	~12 meses
	Supporta 5,000 Operações de Abertura & Fecho
Leds	Azul
Alarme de Bateria Fraca	Na APP e Alarme por voz
Consumo	N/A
Consumo Estático	N/A
Tempo Aberto	5s; 10s; 15s; 30s; 60s; personalizado
Número de Aberturas	~5,000 Aberturas (1Ano)
Software Web	iTEC OnHospitality iTEC OnAccessPRO
Software Windows	iTEC Hybrid
APP's	iTEC iOA
Compatibilidade	IOS 8; Android 5; e superior
Stand Alone	Sim
IP	IP56
Peso	0,70 Kgs
Resistencia à Humidade	30%-95%
Temp. de Funcionamento	-20°C~+55°C
Nº de Código via APP	Ilimitado
Nº de Cód. auto-definido	150
Nº de Impressão Digital	N/A
Nº do cartões de IC	200
Níveis de Usuários	Sim
Código de Gestão	Sim
Cores Disponíveis	Nickel Satin, Dourado, Negro, etc.
Instalação	Residências, Apartamentos, Residenciais, Escritórios, AIRBNB, Hotéis
Espessura de porta	30mm~110mm

en.

Material	Metal alloy, Stainless steel, Glass
Opening Method	Code, Card, Wifi, BLE, APP, Mechanical Key
Identification Time	<0.1S
Communication	Bluetooth 4.1 Mifare (13,56MHz)
Cylinder	ANSI Cylinder type
Cylinder Type	Standard ANSI
Compatibility with locks	Micro USB
Emergency Power	Mechanical Key
Emergency Opening	N/A
Voltage	N/A
Max. Power	~12 months
Battery Life	Supports 5000 Opening & Closing Operations
Leds	Blue
Low Battery Alarm	In the APP and Voice Alarm
Consumption	N/A
Static Consumption	N/A
Time Open	5s; 10s; 15s; 30s; 60s; personalizado
Number of Openings	~5,000 Openings (1Year)
Web Software	iTEC OnHospitality iTEC OnAccessPRO
Windows Software	iTEC Hybrid
APP's	iTEC iOA
Compatibility	IOS 8; Android 5; or previous
Stand Alone	Yes
IP	IP56
Weight	0,70 Kgs
Humidity Resistance	30%-95%
Temp. of Operation	-20°C~+55°C
Code No. via APP	Unlimited
Self-defined Code No.	150
Fingerprint Number	N/A
IC card number	200
User Levels	Yes
Management Code	Yes
Available Colors	Satin Stainless Steel, Gold, Black
Installation	Residences, Apartments, Hostels, Offices, AIRBNB, Hotels
Door thickness	30mm~110mm

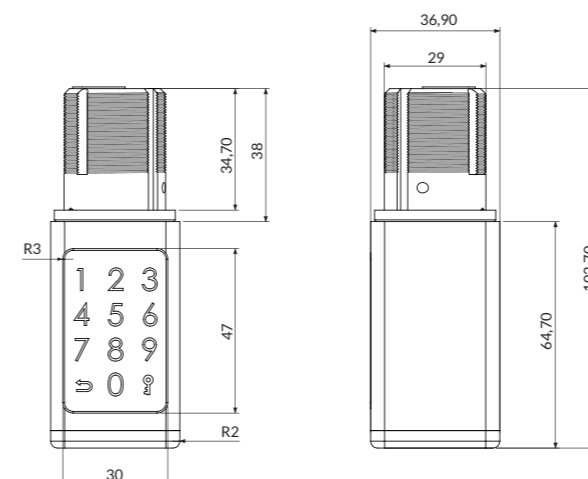

es.

Material	Aleación
Método de apertura	Código, Tarjeta, Wifi, BLE, APP, Llave mecánica
Tiempo de identificación	<0,1 S
Comunicación	Bluetooth 4.1; Mifare (13,56 MHz)
Bombillo	ANSI
Tipo de cerraduras	Pestillo ITSL
Voltaje	Micro USB
Apertura de emergencia	Llave mecánica
Duración de la batería	CC 6 V (AA * 4)
Energía máxima	6V-MAX
Duración de la Bateria	~ 12 meses
	Admite ~ 5,000 operaciones de apertura y cierre
Leds	Azul
Alarma de batería baja	En la aplicación y alarma por voz Por debajo de 4,8 V
Consumo	<200 mA
Consumo estático	65µA
Tiempo Aberto	5s; 10s; 15s; 30s; 60s;
Numero de aperturas	~ 5,000 aperturas (1 año)
Software Web	iTEC OnHospitality iTEC OnAccessPRO
Software de Windows	iTEC Hybrid
Aplicaciones	iTEC iOA
Compatibilidad	IOS 8; Android 5; o superior
Stand Alone	Sí
IP	IP55
Peso	2,10 kilogramos
Resistencia a la humedad	30% -95%
Temperatura de operación	-20°C ~ + 55°C
No. de código vía APP	Ilimitado
No. Código auto-definido	150
Número de huella digital	N/A
Número de tarjeta IC	200
Niveles de usuario	Sí
Código de gestión	Sí
Colores disponibles	Níquel satinado
Instalación	Residencias, Apartamentos, Hostales, Oficinas, AIRBNB, Hoteles
Espesor de puerta	30 mm ~ 55 mm

fr.

Matériel	Alliage
Méthode d'ouverture	Code, carte, Wifi, BLE, APP, clé mécanique
Temps d'identification	<0,1 S
Communication	Bluetooth 4.1 Mifare (13,56 MHz)
Cylindre	ANSI
Compatibilité avec les serrures	Loquet ITSL
Ouverture d'urgence	Micro USB
Alimentation de secours	Clé mécanique
Max. Puissance	DC 6 v (AA * 4)
Vie de la batterie	6V-MAX
Max. Puissance	~ 12 mois
Vie de la batterie	Prend en charge environ 5000 opérations d'ouverture et de fermeture
Leds	Bleu
Alarme de batterie faible	Dans l'application et l'alarme vocale En dessous de 4,8V
Consommation	<200 mA
Consommation statique	65µA
Temps ouvert	14s; 10s; 15s; 30s; 60s; Douane
Nombre d'ouvertures	~ 5000 ouvertures (1 an)
Logiciel Web	iTEC OnHospitality iTEC OnAccessPRO
Logiciel Windows	iTEC Hybrid
Applications	iTEC iOA
Compatibilité	IOS 8; Android 5; ou supérieur
Autonome	Oui
IP	IP55
Poids	2,10 kilogrammes
Résistance à l'humidité	30% -95%
Temp. De fonctionnement	-20 ° C à + 55 ° C
N ° de code via APP	Illimité
N ° de code auto-défini	150
Numéro d'empreinte digitale	N/A
Numéro de carte IC	200
Niveaux d'utilisateurs	Oui
Code de gestion	Oui
Couleurs disponibles	Nickel satiné
Installation	Résidences, appartements, auberges, bureaux, AIRBNB, hôtels
Épaisseur de la porte	30 mm à 55 mm

iCylinder MT eur[®]



-
-
-
-
-
-
-

pt. O iCylinder MT é um cilindro eletrónico sem fio que permite controlar facilmente o acesso com o seu smartphone através do iTEC on Access. O iCylinder MT possui um motor integrado, que permite destrancar a porta sem girar manualmente o cilindro.

en. iCylinder MT is a wireless electronic cylinder that lets you easily control access with your smartphone through iTEC on Access, iCylinder MT has an integrated motor, that allows your to unlock the door without manually rotating the cylinder.

es. iCylinder MT es un cilindro electrónico inalámbrico que le permite controlar fácilmente el acceso con su teléfono inteligente a través de iTEC on Access, iCylinder MT tiene un motor integrado que le permite desbloquear la puerta sin girar manualmente el cilindro.

fr. iCylinder MT est un cylindre électronique sans fil qui vous permet de contrôler facilement l'accès avec votre smartphone via iTEC sur Access. iCylinder MT dispose d'un moteur intégré, qui vous permet de déverrouiller la porte sans faire tourner manuellement le cylindre.



<p><i>Smart Relay</i></p> <p>iMT SMR01</p>	<p><i>Gateway iMT</i></p> <p>iMT</p>	<p><i>Door Sensor</i></p> <p>iMT DS</p>
<p><i>Keypad</i></p> <p>iMT KP01</p>	<p><i>Fingerprint Sensor</i></p> <p>iMT FPW</p>	<p><i>Keypad & Card Sensor</i></p> <p>iMT LT01</p>

iCylinder MT eur[®]

Ficha Técnica

Datasheet

Hoja Técnica

Fiche Technique

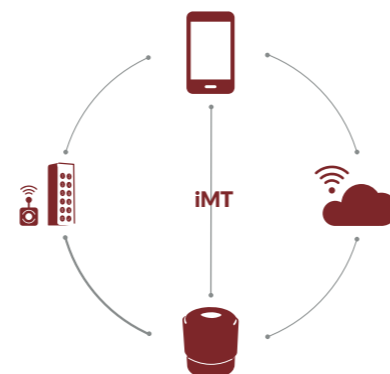

pt.		en.	
Material	Liga Alumínio e ABS.	Material	Aluminum Alloy, ABS
Método de Abertura	Wifi, BLE, APP Opcional: RFID, Código e Impressão Digital.	Opening Method	Wifi, BLE, APP Optional: RFID, Code, Fingerprint
Tempo de Indentificação	<2.0S	Identification Time	<2.0S
Comunicação	Bluetooth 4.1	Communication	Bluetooth 4.1
Cilindro	2,4Ghz	Keypad	N/A
Compatibilidade com fechaduras	Cilindro Europeu Standard Europeu	Cylinder Type	European Type
Energia de Emergência	N/A	Compatibility with locks	European Standard
Abertura de Emergência	Chave mecânica	Emergency Power	N/A
Potência	DC 9v (CR123A * 3)	Emergency Opening	Mechanical Key
Máx. Potência	9V-MAX	Voltage	DC 9v (CR123A * 3)
Vida Útil da Bateria	~ 6 meses	Max. Power	9V-MAX
	Suporta 2000 Operações de Abertura e Fecho	Battery Life	~ 6 months
			Supports 2000 Opening & Closing Operations
Leds	N/A	Leds	N/A
Alarme de Bateria Fraca	APP e Alarme de Voz Abaixo 8.5V	Low Battery Alarm	In the APP and Voice Alarm Below 8.5V
Consumo	<800mA	Consumption	<800mA
Consumo Estático	50µA	Static Consumption	50µA
Tempo Aberto	5s; 10s; 15S; 30s; 60s; custom	Time Open	5s; 10s; 15S; 30s; 60s; custom
Número de Aberturas	~ 2,000 Aberturas (1Año)	Number of Openings	~2,000 Openings (1Year)
APP's	iTEC iMT IOS 8 e superior Android 5 e superior	APP's	iTEC iMT IOS 8 or erlier Android 5 or erlier
Stand Alone	N/A	Stand Alone	N/A
IP	IP68	IP	IP68
Peso	0.6 kg	Weight	0.6 kg
Resistencia à Humidade	30% -95%	Humidity Resistance	30% -95%
Temp. de Funcionamento	-20°C ~ + 55°C	Temp. of Operation	-20°C ~ + 55°C
Nº de Código via APP	N/A	Code No. via APP	N/A
Nº de Cód. auto-definido	N/A	Self-defined Code No.	N/A
Nº de Impressão Digital	N/A	Fingerprint Number	N/A
Nº do cartões de IC	N/A	IC card number	N/A
Níveis de Usuários	Sim	User Levels	Yes
Código de Gestão	Sim	Management Code	Yes
Cores Disponíveis	Cinza Escuro	Available Colors	Dark Grey
Instalação	Residencias, Apartamentos, Residenciais, Escritórios, AIRBNB, Hotéis	Installation	Residences, Apartments, Hostels, Offices, AIRBNB, Hotels
Espessura de porta	30mm ~ 70mm	Door thickness	30mm ~ 70mm

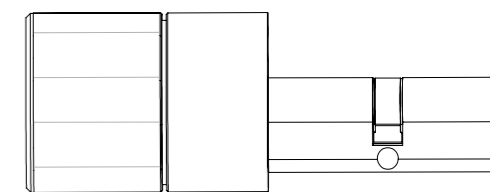
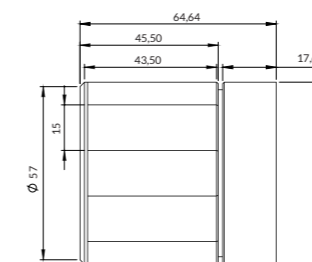
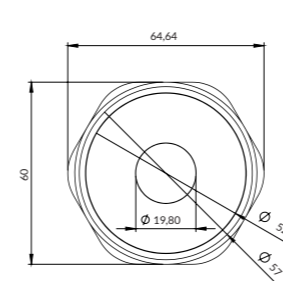

es.		fr.	
Material	Aleación de Aluminio, ABS	Matériel	Alliage d'Aluminium, ABS
Método de apertura	Wifi, BLE, APLICACIÓN Opcional: RFID, Código y Huella Digital	Méthode d'ouverture	Wifi, BLE, APP En option: RFID, Code et empreinte digitale
Tiempo de identificación	<2.0S	Temps d'identification	<2.0S
Comunicación	Bluetooth 4.1	Communication	Bluetooth 4.1
Teclado	Tipo Europeo	Clavier	Type européen
Bombillo	Estándar Europeo	Compatibilité avec les serrures	Norme européenne
Tipo de cerraduras	N/A	Ouverture d'urgence	N/A
Voltaje	Llave mecánica	Alimentation de secours	Clé mécanique
Apertura de emergencia	CC 9 V (CR123A * 3)	Max. Puissance	DC 9 v (CR123A * 3)
Duración de la batería	9V-MAX	Vie de la batterie	9V-MAX
Energia máxima	~ 6 meses	Max. Puissance	~ 6 mois
Duración de la Bateria	Soporta 2000 operaciones de apertura y cierre	Vie de la batterie	Prend en charge 2000 opérations d'ouverture et de fermeture
Leds	N/A	Leds	N/A
Alarma de batería baja	En la aplicación y alarma por voz Por debajo de 8.5V	Alarme de batterie faible	Dans l'application et l'alarme vocale En dessous de 8,5 V
Consumo	<800 mA	Consommation statique	<800 mA
Consumo estático	50µA	Consommation	50µA
Tiempo Aberto	5s; 10s; 15s; 30s; 60s; personalizado	Temps ouvert	5s; 10s; 15S; 30s; 60s; Douane
Numero de aperturas	~ 2,000 aperturas (1 año)	Nombre d'ouvertures	~ 2000 ouvertures (1 an)
APP's	iTEC iMT IOS 8 y superior Android 5 y superior	Applications	iTEC iMT IOS 8 et supérieur Android 5 et supérieur
Stand Alone	N/A	Autonome	N/A
IP	IP68	IP	IP44
Peso	0,6 kg	Poids	0,6 kg
Resistencia a la humedad	30% -95%	Résistance à l'humidité	30% -95%
Temperatura. de operación	-20°C ~ + 55°C	Temp. De fonctionnement	-20 ° C à + 55 ° C
No. de código via APP	N/A	N ° de code via APP	N/A
No. Código autodefinido	N/A	N ° de code auto-défini	N/A
Número de huella digital	N/A	Numéro d'empreinte digitale	N/A
Número de tarjeta IC	N/A	Numéro de carte IC	N/A
Niveles de usuario	Sí	Niveaux d'utilisateurs	Oui
Código de gestión	Sí	Code de gestion	Oui
Colores disponibles	Gris Oscuro	Couleurs disponibles	Gris Foncé
Instalación	Residencias, Apartamentos, Hostales, Oficinas, AIRBNB, Hoteles	Installation	Residences, appartements, auberges, bureaux, AIRBNB, hôtels
Espesor de puerta	30mm ~ 70mm	Épaisseur de la porte	30mm ~ 70mm

iCylinder MT us[®]



-
-
-
-
-
-
-

pt. O iCylinder MT é um cilindro eletrónico sem fio que permite controlar facilmente o acesso com seu smartphone através do iTEC on Access, o iCylinder MT possui um motor integrado, que permite destrancar a porta sem girar manualmente o cilindro.

en. iCylinder MT is a wireless electronic cylinder that lets you easily control access with your smartphone through iTEC on Access, iCylinder MT has an integrated motor, that allows your to unlock the door without manually rotating the cylinder.

es. iCylinder MT es un cilindro electrónico inalámbrico que le permite controlar fácilmente el acceso con su teléfono inteligente a través de iTEC on Access, iCylinder MT tiene un motor integrado que le permite desbloquear la puerta sin girar manualmente el cilindro.

fr. iCylinder MT est un cylindre électronique sans fil qui vous permet de contrôler facilement l'accès avec votre smartphone via iTEC sur Access. iCylinder MT dispose d'un moteur intégré, qui vous permet de déverrouiller la porte sans faire tourner manuellement le cylindre.

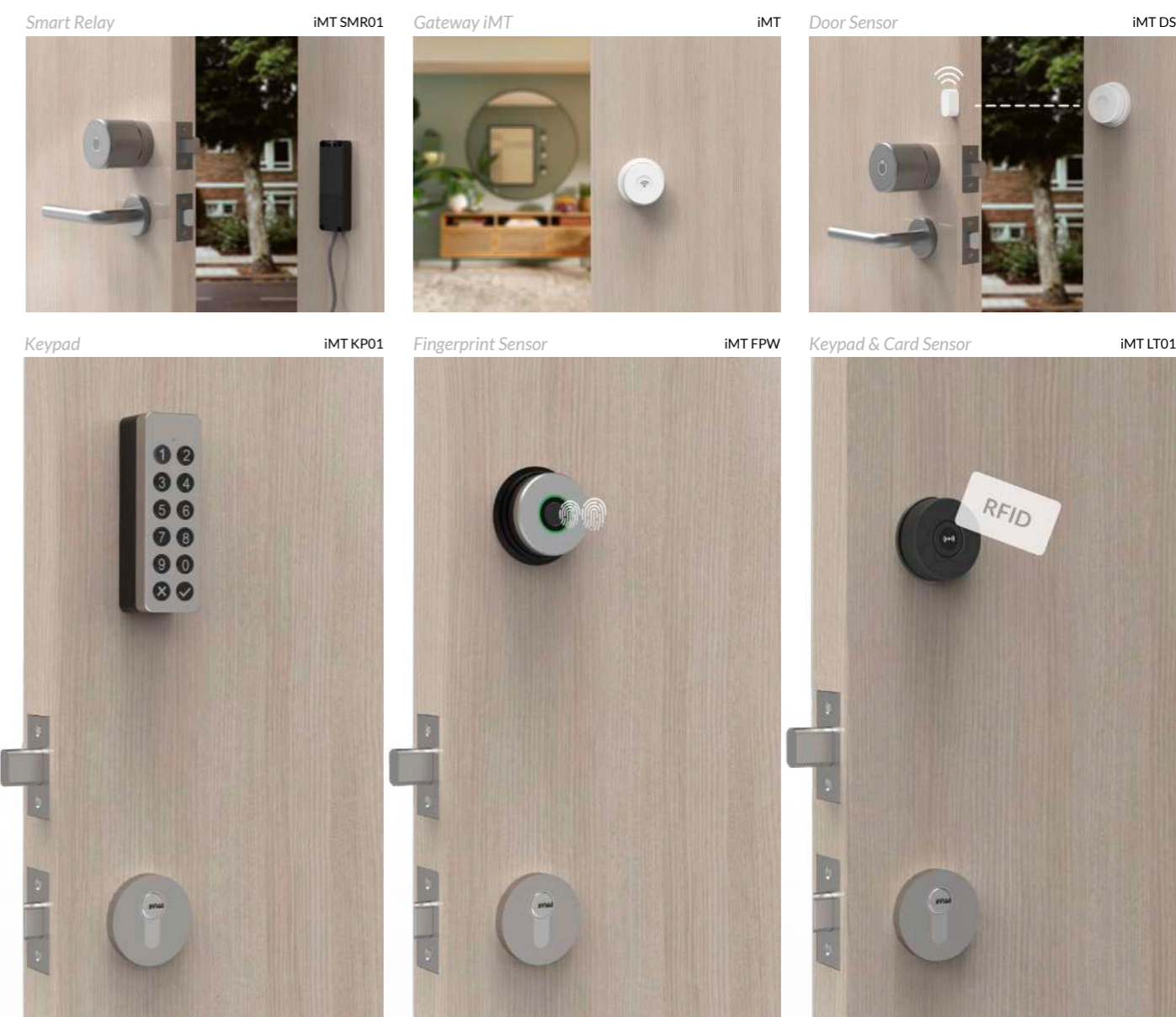
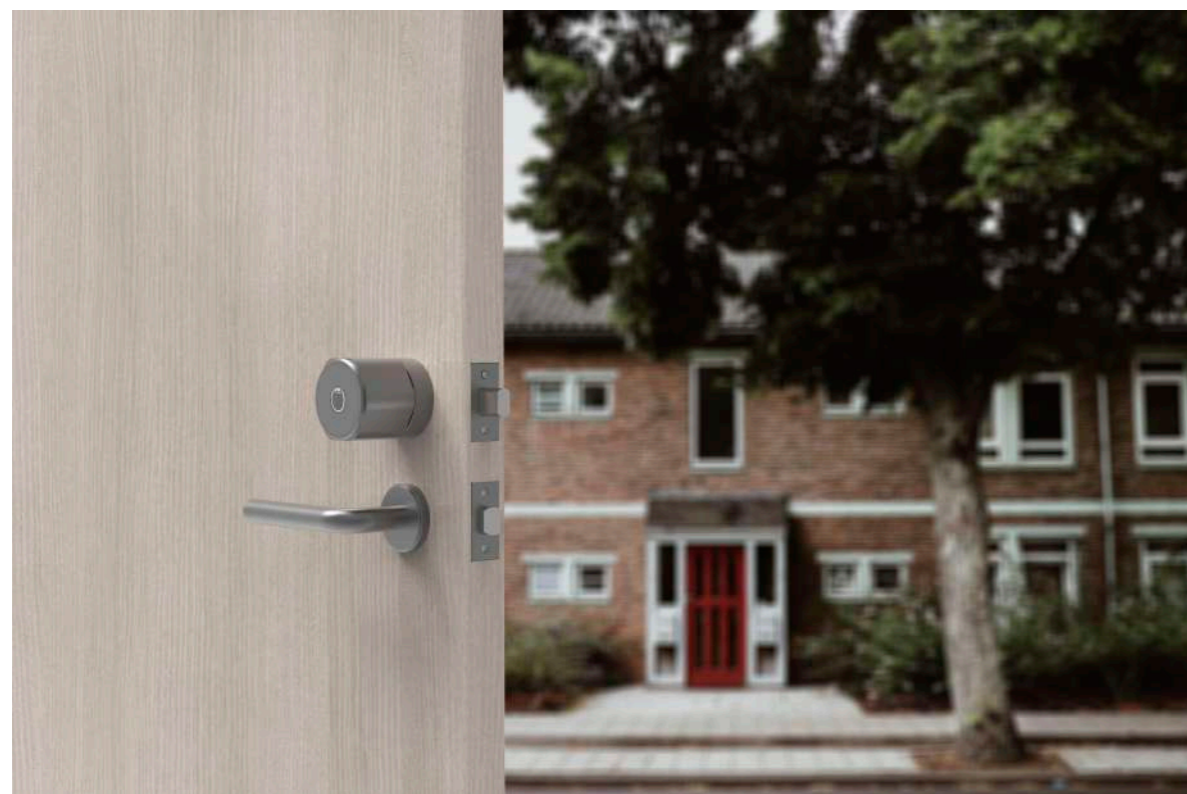

iCylinder MT us®

Ficha Técnica

Datasheet

Hoja Técnica

Fiche Technique

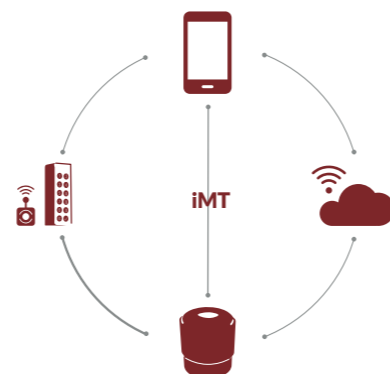

pt.		en.	
Material	Liga Alumínio e ABS.	Material	Aluminum Alloy, ABS
Método de Abertura	Wifi, BLE, APP Opcional: RFID, Código e Impressão Digital.	Opening Method	Wifi, BLE, APP Optional: RFID, Code, Fingerprint
Tempo de Indentificação	<2.0S	Identification Time	<2.0S
Comunicação	Bluetooth 4.1	Communication	Bluetooth 4.1
Cilindro	2,4Ghz	Keypad	N/A
Compatibilidade com fechaduras	Cilindro Europeu Standard Europeu	Cylinder Type	European Type
Energia de Emergência	N/A	Emergency Power	N/A
Abertura de Emergência	Chave mecânica	Emergency Opening	Mechanical Key
Potência	DC 9v (CR123A * 3)	Voltage	DC 9v (CR123A * 3)
Máx. Potência	9V-MAX	Max. Power	9V-MAX
Vida Útil da Bateria	~ 6 meses	Battery Life	~ 6 months
	Suporta 2000 Operações de Abertura e Fecho		Supports 2000 Opening & Closing Operations
Leds	N/A	Leds	N/A
Alarme de Bateria Fraca	APP e Alarme de Voz Abaixo 8.5V	Low Battery Alarm	In the APP and Voice Alarm Below 8.5V
Consumo	<800mA	Consumption	<800mA
Consumo Estático	50µA	Static Consumption	50µA
Tempo Aberto	5s; 10s; 15S; 30s; 60s; custom	Time Open	5s; 10s; 15S; 30s; 60s; custom
Número de Aberturas	~ 2,000 Aberturas (1Año)	Number of Openings	~2,000 Openings (1Year)
APP's	iTEC iMT IOS 8 e superior Android 5 e superior	APP's	iTEC iMT IOS 8 or erlier Android 5 or erlier
Stand Alone	N/A	Stand Alone	N/A
IP	IP68	IP	IP68
Peso	0.6 kg	Weight	0.6 kg
Resistencia à Humidade	30% -95%	Humidity Resistance	30% -95%
Temp. de Funcionamento	-20°C ~ + 55°C	Temp. of Operation	-20°C ~ + 55°C
Nº de Código via APP	N/A	Code No. via APP	N/A
Nº de Cód. auto-definido	N/A	Self-defined Code No.	N/A
Nº de Impressão Digital	N/A	Fingerprint Number	N/A
Nº do cartões de IC	N/A	IC card number	N/A
Níveis de Usuários	N/A	User Levels	Yes
Código de Gestão	Sim	Management Code	Yes
Cores Disponíveis	Sim	Available Colors	Dark Grey
Instalação	Cinza Escuro Residencias, Apartamentos, Residenciais, Escritórios, AIRBNB, Hotéis	Installation	Residences, Apartments, Hostels, Offices, AIRBNB, Hotels
Espessura de porta	30mm ~ 70mm	Door thickness	30mm ~ 70mm

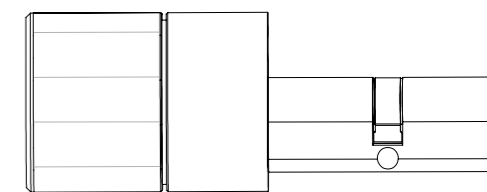
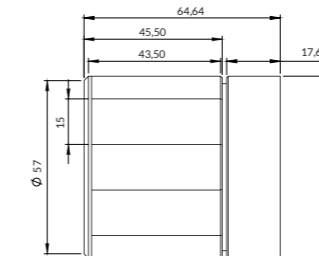
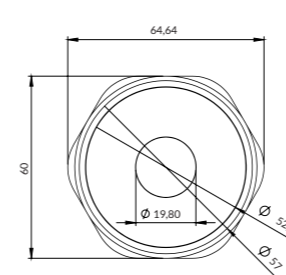

es.		fr.	
Material	Aleación de Aluminio, ABS	Matériel	Alliage d'Aluminium, ABS
Método de apertura	Wifi, BLE, APLICACIÓN Opcional: RFID, Código y Huella Digital	Méthode d'ouverture	Wifi, BLE, APP En option: RFID, Code et empreinte digitale
Tiempo de identificación	<2.0S	Temps d'identification	<2.0S
Comunicación	Bluetooth 4.1	Communication	Bluetooth 4.1
Teclado	Tipo Europeo	Clavier	Type européen
Bombillo	Estándar Europeo	Compatibilité avec les serrures	Norme européenne
Tipo de cerraduras	N/A	Ouverture d'urgence	N/A
Voltaje	Llave mecánica	Alimentation de secours	Clé mécanique
Apertura de emergencia	CC 9 V (CR123A * 3)	Max. Puissance	DC 9 v (CR123A * 3)
Duración de la batería	9V-MAX	Vie de la batterie	9V-MAX
Energia máxima	~ 6 meses	Max. Puissance	~ 6 mois
Duración de la Bateria	Soporta 2000 operaciones de apertura y cierre	Vie de la batterie	Prend en charge 2000 opérations d'ouverture et de fermeture
Leds	N/A	Leds	N/A
Alarma de batería baja	En la aplicación y alarma por voz Por debajo de 8.5V	Alarme de batterie faible	Dans l'application et l'alarme vocale En dessous de 8,5 V
Consumo	<800 mA	Consommation statique	<800 mA
Consumo estático	50µA	Consommation	50µA
Tiempo Aberto	5s; 10s; 15s; 30s; 60s; personalizado	Temps ouvert	5s; 10s; 15S; 30s; 60s; Douane
Numero de aperturas	~ 2,000 aperturas (1 año)	Nombre d'ouvertures	~ 2000 ouvertures (1 an)
APP's	iTEC iMT IOS 8 y superior Android 5 y superior	Applications	iTEC iMT IOS 8 et supérieur Android 5 et supérieur
Stand Alone	N/A	Autonome	N/A
IP	IP68	IP	IP44
Peso	0,6 kg	Poids	0,6 kg
Resistencia a la humedad	30% -95%	Résistance à l'humidité	30% -95%
Temperatura. de operación	-20°C ~ + 55°C	Temp. De fonctionnement	-20 ° C à + 55 ° C
No. de código via APP	N/A	N ° de code via APP	N/A
No. Código autodefinido	N/A	N ° de code auto-défini	N/A
Número de huella digital	N/A	Numéro d'empreinte digitale	N/A
Número de tarjeta IC	N/A	Numéro de carte IC	N/A
Niveles de usuario	Sí	Niveaux d'utilisateurs	Oui
Código de gestión	Sí	Code de gestion	Oui
Colores disponibles	Gris Oscuro	Couleurs disponibles	Gris Foncé
Instalación	Residencias, Apartamentos, Hostales, Oficinas, AIRBNB, Hoteles	Installation	Residences, appartements, auberges, bureaux, AIRBNB, hôtels
Espesor de puerta	30mm ~ 70mm	Épaisseur de la porte	30mm ~ 70mm

iDuo PRO®

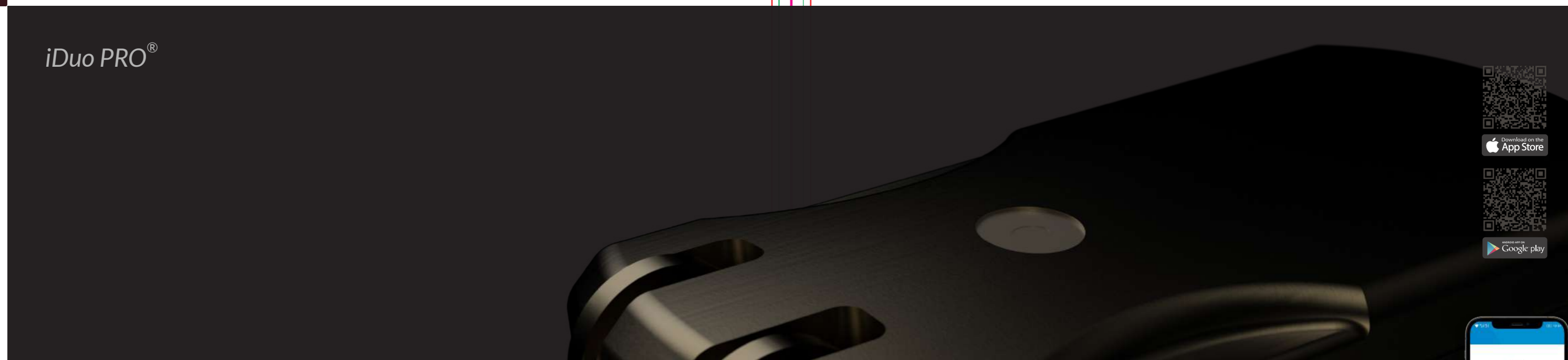

Download on the App Store



GET IT ON Google play

ABS



pt. iDuo PRO é uma fechadura invisível que dificulta o arrombamento da porta, funciona em qualquer tipo de porta. É ativada por controlo remoto através do iDuo Hub. Pode ser controlada através da APP num dispositivo móvel ou através da iDuo Bio. Tem alerta de abertura, de fecho e de bateria fraca.

en. The iDuo PRO is an invisible lock that makes it difficult to break the door, works on any type of door. It is activated by remote control through the iDuo Hub. Can be controlled via the APP on a mobile device or through the iDuo Bio. It has opening, closing and low battery alert.

es. El iDuo PRO es una cerradura invisible que hace difícil romper la puerta, funciona en cualquier tipo de puerta. Se activa por control remoto a través del iDuo Hub. Se puede controlar a través de la app en un dispositivo móvil o a través del iDuo Bio. Tiene apertura, cierre y alerta de batería baja.

fr. L'iDuo PRO est une serrure invisible qui rend difficile de briser la porte, fonctionne sur n'importe quel type de porte. Il est activé par télécommande par l'iDuo Hub. Peut être contrôlé via l'APP sur un appareil mobile ou via l'iDuo Bio. Il a l'ouverture, la fermeture et l'alerte de batterie basse.

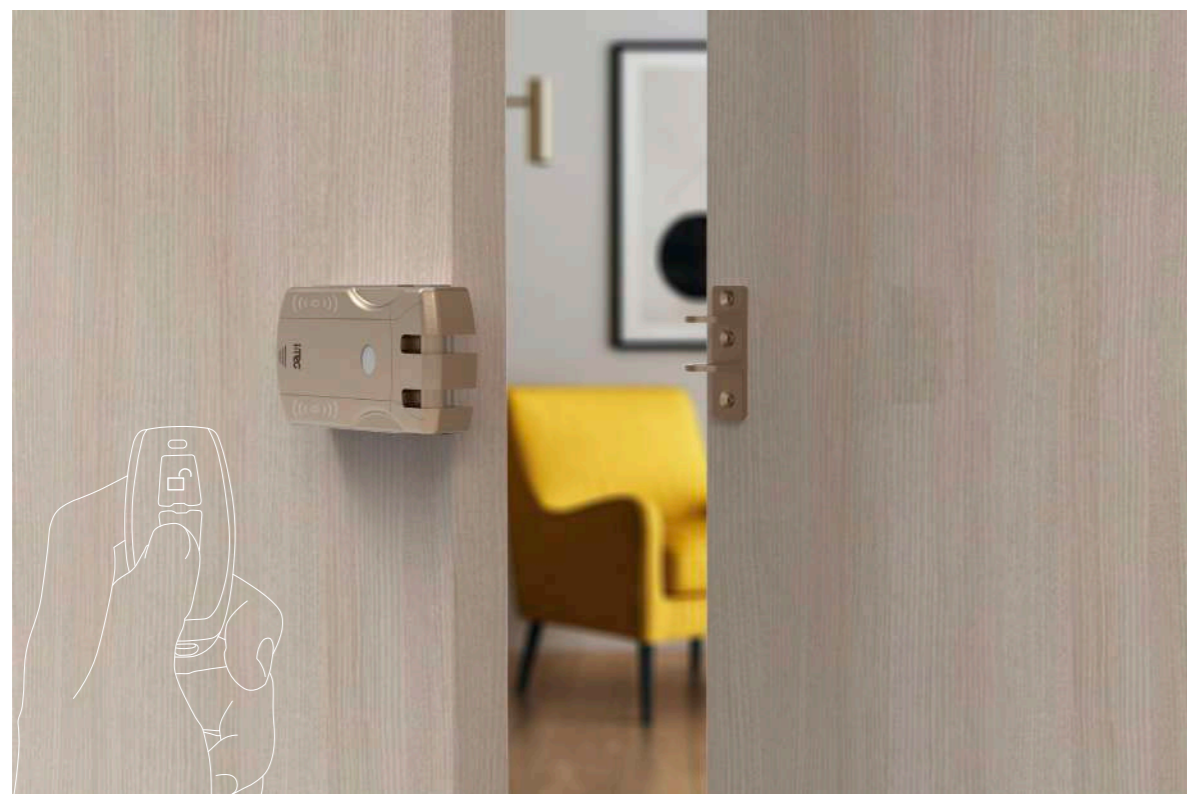

pt. iDuo Bio possibilita abrir a iDuo PRO pelo lado exterior sem a necessidade do controlo remoto ou do smartphone, funcionando tipo leitor de parede, tornando possível a abertura da fechadura através de código e biometria.

en. iDuo Bio allows to open the iDuo PRO from the outside without the need of the remote control or the smartphone, functioning wall-mounted type, making possible the opening of the lock through code and biometrics.

es. iDuo Bio permite abrir el iDuo PRO desde el exterior sin necesidad del mando a distancia o del smartphone, funcionando de tipo montado en la pared, haciendo posible la apertura de la cerradura a través del código y la biometría.

fr. iDuo Bio permet d'ouvrir l'iDuo PRO de l'extérieur sans avoir besoin de la télécommande ou du smartphone, en fonction du type mural, ce qui rend possible l'ouverture de la serrure par le code et la biométrie.

Não se esqueça de controlar o seu iDUO com a nossa **iOT App**

Don't forget to control your iDuo with our **iOT App**

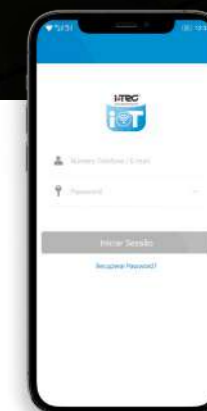

pt. Cores e puxadores disponíveis por pedido
en. Colors and handle available on request
es. Colores y manillas disponibles bajo pedido
fr. Couleurs et poignées disponibles sur demande



LSS
 aço inoxidável lacado
 lacquered stainless steel
 acero inoxidable lacado
 acier inoxydable laqué

SSAB
 aço inoxidável latão antigo
 stainless steel antique brass
 acero inoxidable cobre antiguo
 inox en laiton vieilli

SSS
 aço inoxidável satinado
 satin stainless steel
 acero inoxidable satin
 acier inoxydable satiné

iDuo PRO®

Ficha Técnica

Datasheet

Hoja Técnica

Fiche Technique

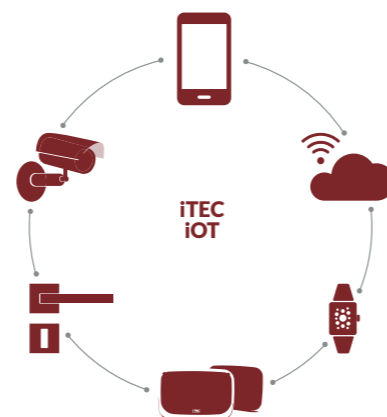

pt.

Material	ABS; Liga Metálica
Método de Abertura	Comando remoto; Toque
Tempo de Identificação	<5,0S
Comunicação	433Mhz (+/- 500Khz)
Cilindro	Sim
Compatibilidade com fechaduras	N/A
Energia de Emergência	N/A
Abertura de Emergência	Jack 3,5mm / AC
Potência	N/A
Máx. Potência	DC 3v (AA*2)
Vida Útil da Bateria	3V-MAX ~6 meses Suporta ~ 2,000 Operações de Abertura & Fecho
Leds	N/A
Alarme de Bateria Fraca	1 bip Abaixo de 2,0V
Consumo	<150mA
Consumo Estático	6µA
Tempo Aberto	Contínuo
Número de Aberturas	~ 2000 aberturas (1Ano)
Software Windows	iTEC IOT (Opção)
Compatibilidade	IOS 8 e superior Android 5 e superior
Stand Alone	Sim
IP	N/A
Peso	0,535 Kg
Resistência à Humidade	30%-95%
Temp. de Funcionamento	-10°C~+ 45°C
Nº de Código via APP	N/A
Nº de Cód. auto-definido	N/A
Impressão Digital	iBIO
Nº de comandos	<15 comandos
Níveis de Usuários	N/A
Código de Gestão	N/A
Cores Disponíveis	Cinza, Dourado, Branco
Instalação	Residências, Apartamentos
Espessura de porta	Indiferente

en.

Material	ABS; Alloy
Opening Method	Remote control; Touch
Identification Time	<5,0S
Communication	433Mhz (+/- 500Khz)
Keypad	Yes
Cylinder Type	N/A
Compatibility with locks	N/A
Emergency Power	Jack 3,5mm / AC
Emergency Opening	N/A
Voltage	DC 3v (AA*2)
Max. Power	3V-MAX
Battery Life	~6 months Supports ~ 2,000 Opening & Closing Operations
Leds	N/A
Low Battery Alarm	1 bip Below 2.0V
Consumption	<150mA
Static Consumption	6µA
Time Open	Continuous
Number of Openings	~2,000 Openings (1Year)
Windows software	iTEC IOT (Option)
Compatibility	IOS 8 or earlier Android 5 or earlier
Stand Alone	Sim
IP	N/A
Weight	0,535 Kg
Humidity Resistance	30%-95%
Temp. of Operation	-10°C~+ 45°C
Code No. via APP	N/A
Self-defined Code No.	N/A
Fingerprint	iBIO
Commands number	<15 commands
User Levels	N/A
Management Code	N/A
Available Colors	Grey, Gold, White
Installation	Residences, Apartments
Door thickness	Indifferent

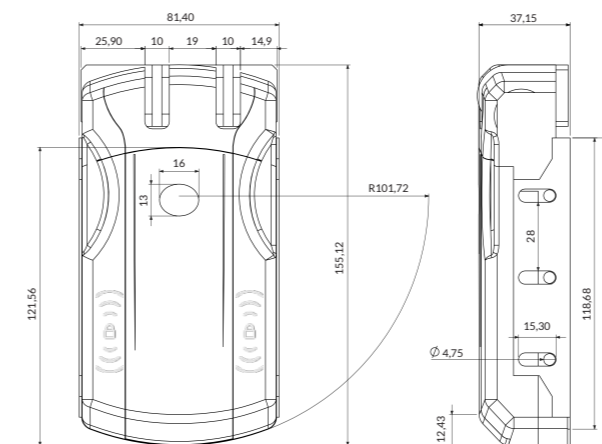

es.

Material	ABS; Aleación
Método de apertura	Control remoto
Tiempo de identificación	<5,0S
Comunicación	433 Mhz (+/- 500 Khz)
Teclado	Sí
Bombillo	N/A
Tipo de cerraduras	N/A
Energía de emergencia	Jack 3,5 mm / CA
Apertura de emergencia	N/A
Voltaje	CC 3 V (AA * 2)
Max. Energía	3V-MAX
Duración de la batería	~ 6 meses Admite ~ 2,000 operaciones de apertura y cierre
Leds	N/A
Alarma de batería baja	1 bip Por debajo de 2,0 V
Consumo	<150 mA
Consumo estático	6µA
Tiempo Aberto	Continuo
Numero de aperturas	~ 2,000 aperturas (1 año)
Software de Windows	iTEC IOT (Opción)
Compatibilidad	IOS 8 o superior Android 5 o superior
Stand Alone	Sí
IP	N/A
Peso	0,535 kilogramos
Resistencia a la humedad	30% -95%
Temperatura. de operación	-10°C ~ + 45°C
No. de código vía APP	N/A
No. Código autodefinido	N/A
Huella digital	iBIO
Número de comandos	<15 comandos
Niveles de usuario	N/A
Código de gestión	N/A
Colores disponibles	Gris, Dorado, Blanco
Instalación	Residencias, Apartamentos
Espesor de puerta	Indiferente

fr.

Matériel	ABS; Alliage
Méthode d'ouverture	Télécommande
Temps d'identification	<5,0S
Communication	433Mhz (+/- 500Khz)
Clavier	Oui
Compatibilité avec les serrures	N/A
Ouverture d'urgence	N/A
Alimentation de secours	Prise jack 3,5 mm / AC
Max. Puissance	N/A
Vie de la batterie	DC 3 v (AA * 2)
Max. Puissance	3V-MAX
Vie de la batterie	~ 6 mois Prend en charge environ 2000 opérations d'ouverture et de clôture
Leds	N/A
Alarme de batterie faible	1 bip En dessous de 2,0 V
Consommation statique	<150 mA
Consommation	6µA
Temps ouvert	Continu
Nombre d'ouvertures	~ 2000 ouvertures (1 an)
Logiciel Windows	iTEC IOT (Option)
Compatibilité	IOS 8 ou supérieur Android 5 ou supérieur
Autonome	Oui
IP	N/A
Poids	0,535 kilogrammes
Résistance à l'humidité	30%-95%
Temp. De fonctionnement	-10 °C à + 45 °C
N ° de code via APP	N/A
N ° de code auto-défini	N/A
D'empreinte digitale	iBIO
Commandes	<15 comandos
Niveaux d'utilisateurs	N/A
Code de gestion	N/A
Couleurs disponibles	Gris, or, blanc
Installation	Résidences, Appartements
Épaisseur de la porte	Indifférent

iDuo ECO®

ABS

2x
AAA

CE

IP44



pt. iDuo ECO é uma fechadura invisível, fácil de instalar em qualquer tipo de porta: madeira, vidro, metal... Com sistema de abertura interior para emergências, é robusta e de grande durabilidade. controle: abrir e fechar. Você pode registrar 16 comandos diferentes em cada fechadura e cada comando pode controlar até 8 fechaduras.

en. iDuo ECO is an invisible lock that is easy to install on any type of door: wood, glass, metal... With an interior opening system for emergencies, it is robust and highly durable. It has a simple two-button remote control: open and close. You can register 16 different commands in each lock and each command can control up to 8 locks.

es. iDuo ECO es una cerradura invisible que es fácil de instalar en cualquier tipo de puerta: madera, vidrio, metal... Con un sistema de apertura interior para emergencias, es robusta y altamente duradera. Tiene un control remoto simple de dos botones: abrir y cerrar. Puede registrar 16 comandos diferentes en cada bloqueo y cada comando puede controlar hasta 8 bloqueos.

fr. iDuo ECO est une serrure invisible facile à installer sur tout type de porte: bois, verre, métal. Dotée d'un système d'ouverture intérieure pour les urgences, elle est très résistante. Elle dispose d'une simple télécommande à deux boutons contrôle: ouvrir et fermer. Vous pouvez enregistrer 16 commandes différentes dans chaque serrure et chaque commande peut contrôler jusqu'à 8 serrures.

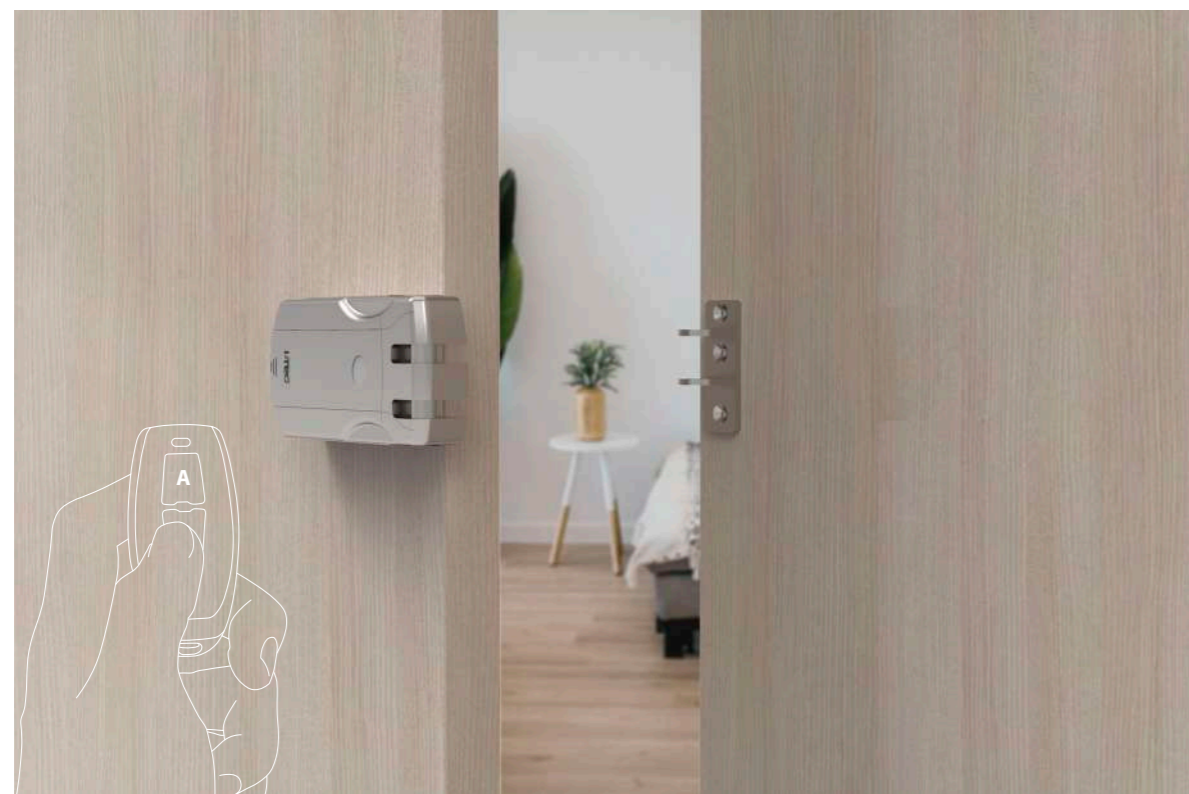
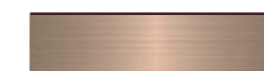
**pt.** Material da porta**en.** Door material**es.** Material de la puerta**fr.** Matériau de la portemadeira
wood
madera
boisvidro
glass
vidrio
verremetal
metal
el metal
métal

Não se esqueça de controlar o seu
iDUO com a nossa **iOT App**

Don't forget to control your
iDuo with our **iOT App**

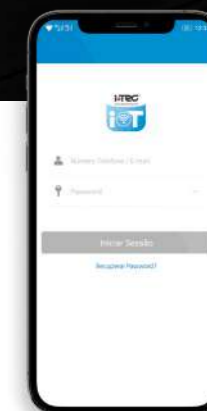
**pt.** Cores e puxadores disponíveis por pedido**en.** Colors and handle available on request**es.** Colores y manillas disponibles bajo pedido**fr.** Couleurs et poignées disponibles sur demande**LSS**aço inoxidável lacado
lacquered stainless steel
acero inoxidable lacado
acier inoxydable laqué**SSAB**aço inoxidável latão antigo
stainless steel antique brass
acero inoxidable cobre antiguo
inox en laiton vieilli**SSS**aço inoxidável satinado
satin stainless steel
acero inoxidable satiné
acier inoxydable satiné

iDuo ECO®**Ficha Técnica**

Datasheet

Hoja Técnica

Fiche Technique

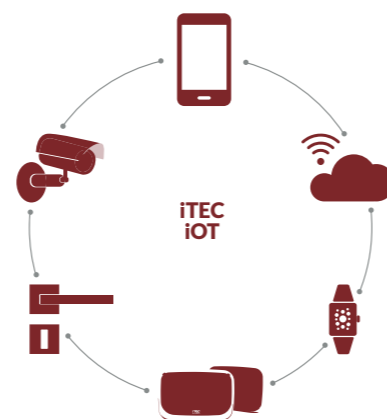
**pt.**

Material	ABS; Liga Metálica
Método de Abertura	Comando remoto; Toque
Tempo de Identificação	<5,0S
Comunicação	433Mhz (+/- 500Khz)
Cilindro	Sim
Compatibilidade com fechaduras	N/A
Energia de Emergência	N/A
Abertura de Emergência	Jack 3,5mm / AC
Potência	N/A
Máx. Potência	DC 3v (AA*2)
Vida Útil da Bateria	3V-MAX ~6 meses Suporta ~ 2,000 Operações de Abertura & Fecho
Leds	N/A
Alarme de Bateria Fraca	1 bip Abaixo de 2,0V
Consumo	<150mA
Consumo Estático	6µA
Tempo Aberto	Contínuo
Número de Aberturas	~ 2000 aberturas (1Ano)
Software Windows	iTEC IOT (Opção)
Compatibilidade	IOS 8 e superior Android 5 e superior
Stand Alone	Sim
IP	N/A
Peso	0,535 Kg
Resistencia à Humidade	30%-95%
Temp. de Funcionamento	-10°C~+ 45°C
Nº de Código via APP	N/A
Nº de Cód. auto-definido	N/A
Impressão Digital	iBIO
Nº de comandos	<15 comandos
Níveis de Usuários	N/A
Código de Gestão	N/A
Cores Disponíveis	Cinza, Dourado, Branco
Instalação	Residencias, Apartamentos
Espessura de porta	Indiferente

en.

Material	ABS; Alloy
Opening Method	Remote control; Touch
Identification Time	<5,0S
Communication	433Mhz (+/- 500Khz)
Keypad	Yes
Cylinder Type	N/A
Compatibility with locks	N/A
Emergency Power	Jack 3,5mm / AC
Emergency Opening	N/A
Voltage	DC 3v (AA*2)
Max. Power	3V-MAX
Battery Life	~6 months Supports ~ 2,000 Opening & Closing Operations
Leds	N/A
Low Battery Alarm	1 bip Below 2.0V <150mA
Consumption	6µA
Static Consumption	6µA
Time Open	Continuous
Number of Openings	~2,000 Openings (1Year)
Windows software	iTEC IOT (Option)
Compatibility	IOS 8 or earlier Android 5 or earlier
Stand Alone	Sim
IP	N/A
Weight	0,535 Kg
Humidity Resistance	30%-95%
Temp. of Operation	-10°C~+ 45°C
Code No. via APP	N/A
Self-defined Code No.	N/A
Fingerprint	iBIO
Commands number	<15 commands
User Levels	N/A
Management Code	N/A
Available Colors	Grey, Gold, White
Installation	Residences, Apartments
Door thickness	Indifferent

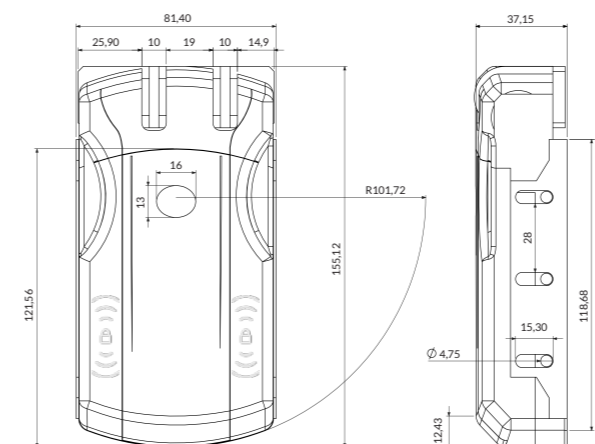
**es.**

Material	ABS; Aleación
Método de apertura	Control remoto
Tiempo de identificación	<5,0S
Comunicación	433 Mhz (+/- 500 Khz)
Teclado	Sí
Bombillo	N/A
Tipo de cerraduras	N/A
Energía de emergencia	Jack 3,5 mm / CA
Apertura de emergencia	N/A
Voltaje	CC 3 V (AA * 2)
Max. Energía	3V-MAX
Duración de la batería	~ 6 meses Admite ~ 2,000 operaciones de apertura y cierre
Leds	N/A
Alarma de batería baja	1 bip Por debajo de 2,0 V <150 mA
Consumo	6µA
Consumo estático	6µA
Tiempo Aberto	Continuo
Numero de aperturas	~ 2,000 aperturas (1 año)
Software de Windows	iTEC IOT (Opción)
Compatibilidad	IOS 8 o superior Android 5 o superior
Stand Alone	Sí
IP	N/A
Peso	0,535 kilogramos
Resistencia a la humedad	30% -95%
Temperatura. de operación	-10°C ~ + 45°C
No. de código vía APP	N/A
No. Código autodefinido	N/A
Huella digital	iBIO
Número de comandos	<15 comandos
Niveles de usuario	N/A
Código de gestión	N/A
Colores disponibles	Gris, Dorado, Blanco
Instalación	Residencias, Apartamentos
Espesor de puerta	Indiferente

fr.

Matériel	ABS; Alliage
Méthode d'ouverture	Télécommande
Temps d'identification	<5,0S
Communication	433Mhz (+/- 500Khz)
Clavier	Oui
Compatibilité avec les serrures	N/A
Ouverture d'urgence	N/A
Alimentation de secours	Prise jack 3,5 mm / AC
Max. Puissance	N/A
Vie de la batterie	DC 3 v (AA * 2)
Max. Puissance	3V-MAX
Vie de la batterie	~ 6 mois Prend en charge environ 2000 opérations d'ouverture et de clôture
Leds	N/A
Alarme de batterie faible	1 bip En dessous de 2,0 V <150 mA
Consommation statique	6µA
Consommation	6µA
Temps ouvert	Continu
Nombre d'ouvertures	~ 2000 ouvertures (1 an)
Logiciel Windows	iTEC IOT (Option)
Compatibilité	IOS 8 ou supérieur Android 5 ou supérieur
Autonome	Oui
IP	N/A
Poids	0,535 kilogrammes
Résistance à l'humidité	30% -95%
Temp. De fonctionnement	-10 °C à + 45 °C
N ° de code via APP	N/A
N ° de code auto-défini	N/A
D'empreinte digitale	iBIO
Commandes	<15 comandos
Niveaux d'utilisateurs	N/A
Code de gestion	N/A
Couleurs disponibles	Gris, or, blanc
Installation	Résidences, Appartements
Épaisseur de la porte	Indifférent

iMCode 03[®]iMCode 03-VT[®]

ZZA

ABS

2x
AAA

CE

IP54



pt. A iMCode 03, é uma fechadura para porta de simples instalação e com gestão por aplicação de telemóvel e web browser. Pode ser controlada via Bluetooth através da aplicação iTEC OnAccess e iTEC OnAccess Pro (iOS e Android) sem a necessidade de internet ou WIFI.

en. The iMCode 03 is a simple door lock that can be installed and managed by mobile phone application and web browser. It can be controlled via Bluetooth via the iTEC OnAccess and iTEC OnAccess Pro application (iOS and Android) without the need for internet or WIFI.

es. El iMCode 03 es una cerradura de puerta simple que se puede instalar y administrar mediante la aplicación de teléfono móvil y el navegador web. Se puede controlar a través de Bluetooth a través de la aplicación iTEC OnAccess e iTEC OnAccess Pro (iOS y Android) sin necesidad de internet o WIFI.

fr. L'iMCode 03 est une serrure de porte simple qui peut être installée et gérée par une application pour téléphone mobile et un navigateur Web. Il peut être contrôlé via Bluetooth via l'application iTEC OnAccess et iTEC OnAccess Pro (iOS et Android) sans recourir à Internet ni au WIFI.



pt. Idêntico ao modelo iMCode 03, a iMCode 03-VT destaca-se pelo método de trinco vertical (fechadura de trinco morto embutido na porta), com um design mais elegante e provido de maior segurança.

en. Similar to the iMCode 03 model, the iMCode 03-VT stands out for its vertical latch method (dead latch lock built into the door), with a more elegant design and greater security.

es. Similar al modelo iMCode 03, el iMCode 03-VT destaca por su método de pestillo vertical (cerrojo pestillo integrado en la puerta), con un diseño más elegante y mayor seguridad.

fr. Semblable au modèle iMCode 03, l'iMCode 03-VT se distingue par sa méthode de verrouillage vertical (serrure à pêne dormant intégrée à la porte), avec un design plus élégant et une plus grande sécurité.

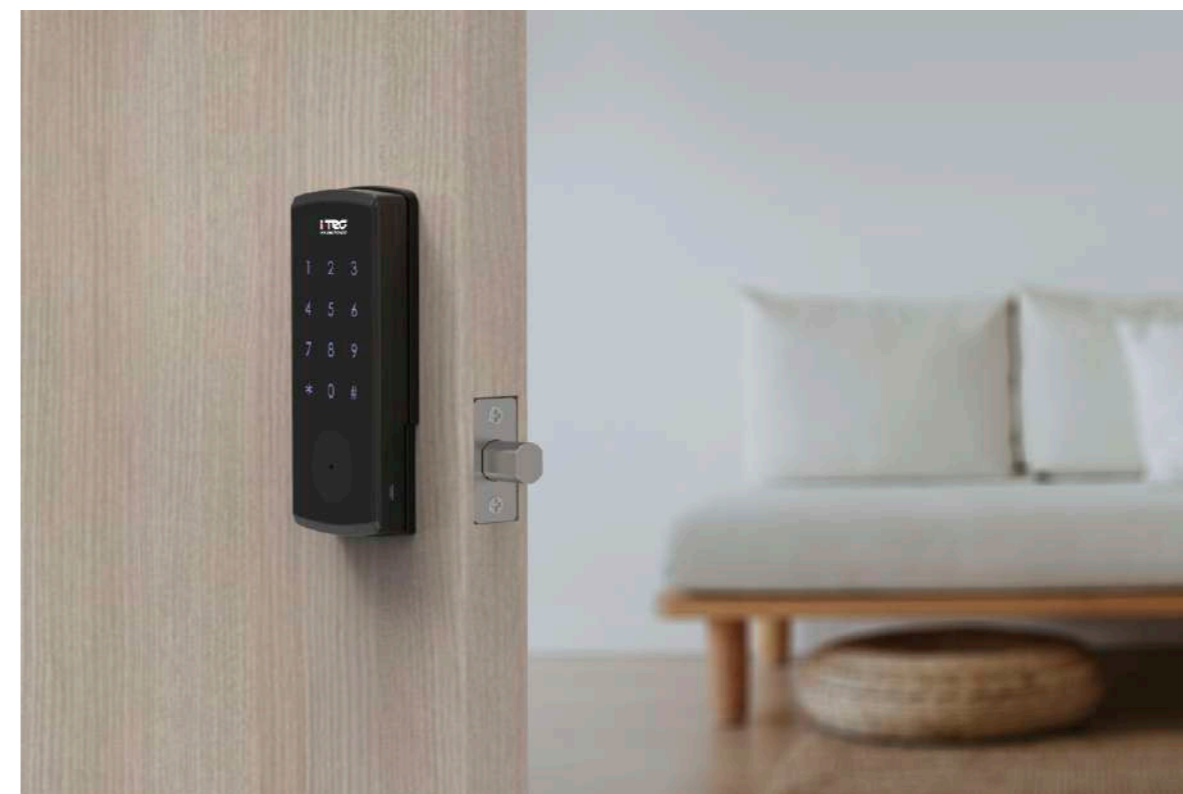

ZZA

ABS

4x
AAA

CE

IP54



iMCode 03[®]

Ficha Técnica

Datasheet

Hoja Técnica

Fiche Technique

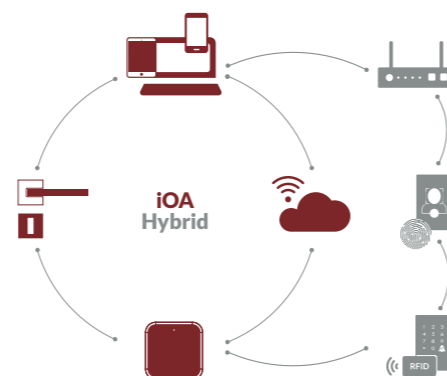

pt.		en.	
Material	Liga Metálica	Material	Zinc Alloy
Método de Abertura	Código , Cartão, Wifi, BLE, APP, Chave Mecânica	Opening Method	Code, Card, Wifi, BLE, APP, Mechanical Key
Tempo de Identificação	<0.1S	Identification Time	<0.1S
Comunicação	Bluetooth 4.1	Communication	Bluetooth 4.1
Cilindro	Sim	Keypad	Yes
Compatibilidade com fechaduras	Próprio	Cylinder Type	Own
Energia de Emergência	Micro USB	Compatibility with locks	N/A
Abertura de Emergência	Chave Mecânica	Emergency Power	Micro USB
Potência	DC 6v (AAA*4)	Emergency Opening	Mechanical Key
Máx. Potência	6V-MAX	Voltage	DC 6v (AAA*4)
Vida Útil da Bateria	~12 meses	Max. Power	6V-MAX
	Suporta ~ 5,000 Operações de Abertura & Fecho	Battery Life	~ 12 months
			Supports ~ 5,000 Opening & Closing Operations
Leds	Branco	Leds	White
Alarme de Bateria Fraca	Na APP e Alarme por voz	Low Battery Alarm	In the APP and Voice Alarm
	Abaixo de 4,8V		Below 4,8V
Consumo	<200mA	Consumption	<200mA
Consumo Estático	65µA	Static Consumption	65µA
Tempo Aberto	5s; 10s; 15S; 30s; 60s; personalizado	Time Open	11s; 10s; 15S; 30s; 60s; custom
Número de Aberturas	~5000 Aberturas (1Ano)	Number of Openings	~5,000 Openings (1Year)
Software Web	iTEC OnHospitality iTEC OnAccessPRO	Web Software	iTEC OnHospitality iTEC OnAccessPRO
Software Windows	iTEC Hybrid	Windows Software	iTEC Hybrid
APP's	iTEC iOA	APP's	iTEC iOA
Compatibilidade Stand Alone	IOS 8; Android 5; e superior	Compatibility Stand Alone	IOS 8; Android 5; or earlier
IP	IP56	IP	IP56
Peso	1,78 Kg	Weight	1,78 Kg
Resistencia à Humidade	30%-95%	Humidity Resistance	30%-95%
Temp. de Funcionamento	-20°C~+55°C	Temp. of Operation	-20°C~+55°C
Nº de Código via APP	Ilimitado	Code No. via APP	Unlimited
Nº de Cód. auto-definido	150	Self-defined Code No.	150
Nº de Impressão Digital	N/A	Fingerprint Number	N/A
Nº do cartões de IC	200	IC card number	200
Níveis de Usuários	Sim	User Levels	Yes
Código de Gestão	Sim	Management Code	Yes
Cores Disponíveis	Negro	Available Colors	Black
Instalação	Residências, Apartamentos, Residenciais, Escritórios, AIRBNB, Hotéis	Installation	Residences, Apartments, Hostels, Offices, AIRBNB, Hotels
		Door thickness	30mm~75mm
Espessura de porta	30mm~75mm		

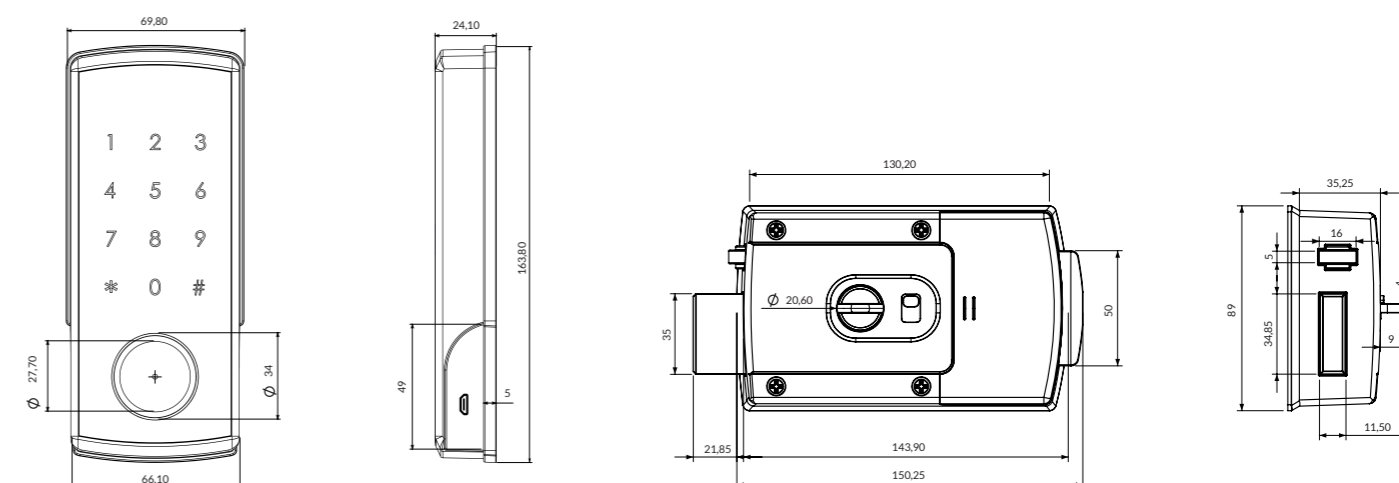

es.		fr.	
Material	Aleación	Matériel	Alliage
Método de apertura	Código, Tarjeta, Wifi, BLE, APP, Llave mecánica	Méthode d'ouverture	Code, carte, Wifi, BLE, APP, clé mécanique
Tiempo de identificación	<0,1 S	Temps d'identification	<0,1 S
Comunicación	Bluetooth 4.1	Communication	Bluetooth 4.1
Teclado	N/A	Clavier	Oui
Bombillo	Sí	Compatibilité avec les serrures	Propre
Tipo de cerraduras	Propio	Ouverture d'urgence	Micro USB
Voltaje	N/A	Alimentation de secours	Clé mécanique
Apertura de emergencia	Micro USB	Max. Puissance	DC 6 v (AAA * 4)
Duración de la batería	Llave mecánica	Vie de la batterie	6V-MAX
Energía máxima	CC 6 V (AAA * 4)	Max. Puissance	~ 12 mois
Duración de la Bateria	6V-MAX	Vie de la batterie	~ 12 meses
	Admite ~ 5,000 operaciones de apertura y cierre		Admet ~ 5,000 opérations d'ouverture et de fermeture
Leds	Blanco	Leds	Blanc
Alarma de batería baja	En la aplicación y alarma por voz	Alarme de batterie faible	Dans l'application et l'alarme vocale
	Por debajo de 4,8 V		En dessous de 4,8V
Consumo	<200 mA	Consommation statique	<200 mA
Consumo estático	65µA	Consommation	65µA
Tempo Aberto	5s; 10s; 15s; 30s; 60s; personalizado	Temps ouvert	11s; 10s; 15S; 30s; 60s; Douane
Numero de aperturas	~ 5,000 aperturas (1 año)	Nombre d'ouvertures	~ 5000 ouvertures (1 an)
Software Web	iTEC OnHospitality iTEC OnAccessPRO	Logiciel Web	iTEC OnHospitality iTEC OnAccessPRO
Software de Windows	iTEC Hybrid	Logiciel Windows	iTEC Hybrid
Aplicaciones	iTEC iOA	Applications	iTEC iOA
Compatibilidad Stand Alone	IOS 8; Android 5; o superior	Compatibilité Autonome	IOS 8; Android 5; ou supérieur
IP	N/A	IP	N/A
Peso	1,78 kilogramos	Poids	1,78 kilogrammes
Resistencia a la humedad	30% -95%	Résistance à l'humidité	30% -95%
Temperatura de operación	-20°C ~ + 55°C	Temp. De fonctionnement	-20 ° C à + 55 ° C
No. de código vía APP	Ilimitado	N ° de code via APP	Illimité
No. Código autodefinido	150	N ° de code auto-défini	150
Número de huella digital	N/A	Numéro d'empreinte digitale	N/A
Número de tarjeta IC	200	Numéro de carte IC	200
Niveles de usuario	Sí	Niveaux d'utilisateurs	Oui
Código de gestión	Sí	Code de gestion	Oui
Colores disponibles	Negro	Couleurs disponibles	Noir
Instalación	Residencias, Apartamentos, Hostales, Oficinas, AIRBNB, Hoteles	Installation	Residences, appartements, auberges, bureaux, AIRBNB, hôtels
Espeor de puerta	30 mm ~ 75 mm	Épaisseur de la porte	30 mm à 75 mm

iMCode 03-VT[®]

Ficha Técnica

Datasheet

Hoja Técnica

Fiche Technique

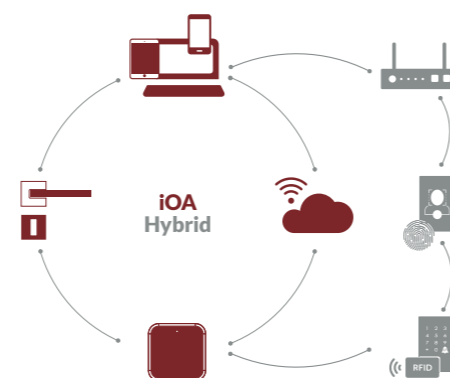

pt.

Material	Liga Metálica
Método de Abertura	Código , Cartão, Wifi, BLE, APP, Chave Mecânica
Tempo de Identificação	<0.1S
Comunicação	Bluetooth 4.1
Cilindro	Sim
Compatibilidade com fechaduras	Próprio
Energia de Emergência	Micro USB
Abertura de Emergência	Chave Mecânica
Potência	DC 6v (AAA*4)
Máx. Potência	6V-MAX
Vida Útil da Bateria	~12 meses
	Suporta ~ 5,000 Operações de Abertura & Fecho
Leds	Branco
Alarme de Bateria Fraca	Na APP e Alarme por voz
	Abaixo de 4,8V
Consumo	<200mA
Consumo Estático	65µA
Tempo Aberto	5s; 10s; 15S; 30s; 60s; personalizado
Número de Aberturas	~5000 Aberturas (1Ano)
Software Web	iTEC OnHospitality iTEC OnAccessPRO
Software Windows	iTEC Hybrid
APP's	iTEC iOA
Compatibilidade Stand Alone	IOS 8; Android 5; e superior
IP	N/A
Peso	IP56
Resistencia à Humidade	1,78 Kg
Temp. de Funcionamento	30%-95%
Nº de Código via APP	-20°C~+55°C
Nº de Cód. auto-definido	Ilimitado
Nº de Impressão Digital	150
Nº do cartões de IC	N/A
Níveis de Usuários	200
Código de Gestão	Sim
Cores Disponíveis	Sim
Instalação	Negro
	Residencias, Apartamentos, Residenciais, Escritórios, AIRBNB, Hotéis
Espessura de porta	30mm~75mm

en.

Material	Zinc Alloy
Opening Method	Code, Card, Wifi, BLE, APP, Mechanical Key
Identification Time	<0.1S
Communication	Bluetooth 4.1
Keypad	Yes
Cylinder Type	Own
Compatibility with locks	N/A
Emergency Power	Micro USB
Emergency Opening	Mechanical Key
Voltage	DC 6v (AAA*4)
Max. Power	6V-MAX
Battery Life	~ 12 months
	Supports ~ 5,000 Opening & Closing Operations
Leds	White
Low Battery Alarm	In the APP and Voice Alarm
	Below 4,8V
Consumption	<200mA
Static Consumption	65µA
Time Open	11s; 10s; 15S; 30s; 60s; custom
Number of Openings	~5,000 Openings (1Year)
Web Software	iTEC OnHospitality iTEC OnAccessPRO
Windows Software	iTEC Hybrid
APP's	iTEC iOA
Compatibility Stand Alone	IOS 8; Android 5; or earlier
IP	N/A
Weight	IP56
Humidity Resistance	1,78 Kg
Temp. of Operation	30%-95%
Code No. via APP	-20°C~+55°C
Self-defined Code No.	Unlimited
Fingerprint Number	150
IC card number	N/A
User Levels	200
Management Code	Yes
Available Colors	Yes
Installation	Black
	Residences, Apartments, Hostels, Offices, AIRBNB, Hotels
Door thickness	30mm~75mm

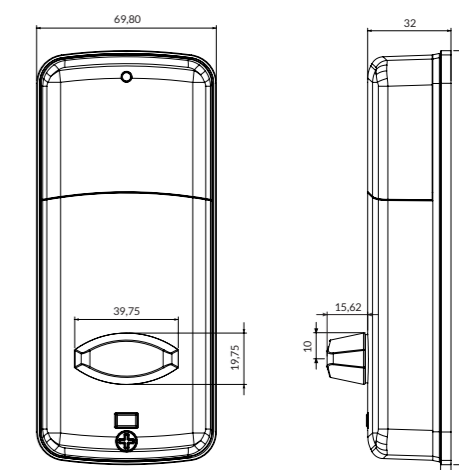
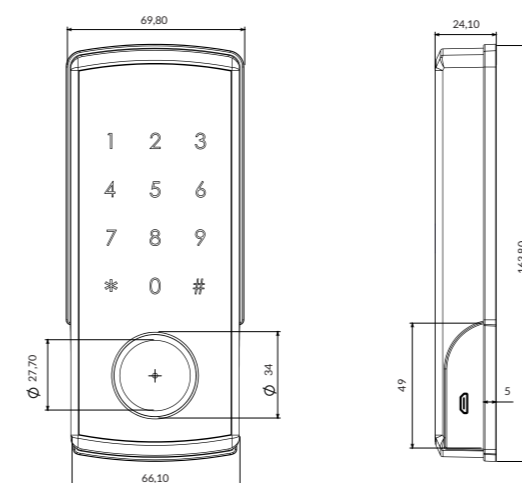

es.

Material	Aleación
Método de apertura	Código, Tarjeta, Wifi, BLE, APP, Llave mecánica
Tiempo de identificación	<0,1 S
Comunicación	Bluetooth 4.1
Teclado	N/A
Bombillo	Sí
Tipo de cerraduras	Propio
Voltaje	N/A
Apertura de emergencia	Micro USB
Duración de la batería	Llave mecánica
Energía máxima	CC 6 V (AAA * 4)
Duración de la Bateria	6V-MAX
	~ 12 meses
	Admite ~ 5,000 operaciones de apertura y cierre
Leds	Blanco
Alarma de batería baja	En la aplicación y alarma por voz
	Por debajo de 4,8 V
Consumo	<200 mA
Consumo estático	65µA
Tiempo Aberto	5s; 10s; 15s; 30s; 60s; personalizado
Numero de aperturas	~ 5,000 aperturas (1 año)
Software Web	iTEC OnHospitality iTEC OnAccessPRO
Software de Windows	iTEC Hybrid
Aplicaciones	iTEC iOA
Compatibilidad Stand Alone	IOS 8; Android 5; o superior
IP	N/A
Peso	IP56
Resistencia a la humedad	1,78 kilogramos
Temperatura de operación	30% -95%
No. de código vía APP	-20°C ~ + 55°C
No. Código autodefinido	Ilimitado
Número de huella digital	150
Número de tarjeta IC	N/A
Niveles de usuario	200
Código de gestión	Sí
Colores disponibles	Sí
Instalación	Negro
	Residencias, Apartamentos, Hostales, Oficinas, AIRBNB, Hoteles
Espeor de puerta	30 mm ~ 75 mm

fr.

Matériel	Alliage
Méthode d'ouverture	Code, carte, Wifi, BLE, APP, clé mécanique
Temps d'identification	<0,1 S
Communication	Bluetooth 4.1
Clavier	Oui
Compatibilité avec les serrures	Propre
Ouverture d'urgence	Micro USB
Alimentation de secours	Clé mécanique
Max. Puissance	DC 6 v (AAA * 4)
Vie de la batterie	6V-MAX
Max. Puissance	~ 12 mois
Vie de la batterie	Prend en charge environ 5000 opérations d'ouverture et de fermeture
Leds	Blanc
Alarme de batterie faible	Dans l'application et l'alarme vocale
	En dessous de 4,8V
Consommation statique	<200 mA
Consommation	65µA
Temps ouvert	11s; 10s; 15S; 30s; 60s; Douane
Nombre d'ouvertures	~ 5000 ouvertures (1 an)
Logiciel Web	iTEC OnHospitality iTEC OnAccessPRO
Logiciel Windows	iTEC Hybrid
Applications	iTEC iOA
Compatibilité Stand Alone	IOS 8; Android 5; ou supérieur
Autonome	N/A
IP	IP56
Poids	1,78 kilogrammes
Résistance à l'humidité	30% -95%
Temp. De fonctionnement	-20 ° C à + 55 ° C
N ° de code via APP	Ilimité
N ° de code auto-défini	150
Numéro d'empreinte digitale	N/A
Numéro de carte IC	200
Niveaux d'utilisateurs	Oui
Code de gestion	Oui
Couleurs disponibles	Noir
Installation	Residences, appartements, auberges, bureaux, AIRBNB, hôtels
Épaisseur de la porte	30 mm à 75 mm



ZZA

ABS

4x
AAA

CE

IP54



pt. A iMGlass é uma fechadura desenvolvida para ser aplicada em portas de vidro, funciona através de cartão RFID, com código PIN, através de impressão digital e ainda por bluetooth, ligado à aplicação iTEC OnAccess, iTEC OnAccess Pro e iTEC Hybrid (iOS e Android).

en. The iMGlass is a lock designed to be applied to glass doors, works through RFID card, PIN code, fingerprint and even bluetooth, connected to the APP iTEC OnAccess, iTEC OnAccess Pro and iTEC Hybrid (iOS and Android).

es. El iMGlass, una cerradura diseñada para ser aplicada a puertas de vidrio, funciona mediante tarjeta RFID, código PIN, huella digital e incluso bluetooth, conectada a la aplicación iTEC OnAccess, iTEC OnAccess Pro e iTEC Hybrid (iOS y Android).

fr. L'iMGlass, une serrure conçue pour être appliquée aux portes vitrées, fonctionne via une carte RFID, un code PIN, une empreinte digitale et même un bluetooth, connecté à l'application iTEC OnAccess, iTEC OnAccess Pro et iTEC Hybrid (iOS et Android).



iMGlass®

Ficha Técnica

Datasheet

Hoja Técnica

Fiche Technique

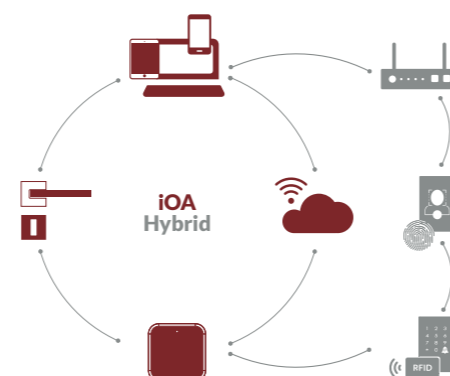
**pt.**

Material	Liga metálica, Inox, Acrílico
Método de Abertura	Impressão Digital, Código, Cartão, Wifi, BLE, APP, Comando
Tempo de Identificação	<5,0S
Comunicação	Bluetooth 4.1 Mifare (13,56MHz)
Teclado	Sim
Cilindro	N/A
Compatibilidade com fechaduras	Modelo próprio
Energia de Emergência	Micro USB
Abertura de Emergência	N/A
Potência	DC 6v (AA*4)
Máx. Potência	6V-MAX
Vida Útil da Bateria	~12 meses Suporta ~ 2,500 Operações de Verde, Vermelho
Leds	Verde, Vermelho
Alarma de Bateria Fraca	Na APP e Alarma por voz
Consumo	<200mA
Consumo Estático	65µA
Tempo Aberto	5s; 10s; 15S; 30s; 60s; personalizado ~2,500 Aberturas (1Ano)
Número de Aberturas	iTEC OnHospitality
Software Web	iTEC OnAccessPRO iTEC Hybrid
Software Windows	iTEC iOA
APP's	IOS 8; Android 5; e superior
Compatibilidade	Sim
Stand Alone	IP44
IP	1,82 Kg
Peso	30%-95%
Resistência à Humidade	-20°C~+55°C
Temp. de Funcionamento	Ilimitado
Nº de Código via APP	60
Nº de Cód. auto-definido	60
Nº de Impressão Digital	100
Nº do cartões de IC	Sim
Níveis de Usuários	Sim
Código de Gestão	Negro, Cromado, Inox
Cores Disponíveis	Residencias, Apartamentos, Residenciais, Escritórios, AIRBNB, Hotéis
Instalação	
Espessura de porta	10mm~12mm

en.

Material	Zinc Alloy, Stainless, Acrylic
Opening Method	Fingerprint, Code, Card, Wifi, BLE, APP, Command
Identification Time	<5,0S
Communication	Bluetooth 4.1 Mifare (13,56MHz)
Keypad	Yes
Cylinder Type	N/A
Compatibility with locks	Own model
Emergency Power	Micro USB
Emergency Opening	Mechanical Key
Voltage	DC 6v (AA*4)
Max. Power	6V-MAX
Battery Life	~ 12 months Supports ~ 5,000 Operations Green, red
Leds	In the APP and Voice Alarm
Low Battery Alarm	Below 4,8V
Consumption	<200mA
Static Consumption	65µA
Time Open	16s; 10s; 15S; 30s; 60s; custom
Number of Openings	~2,500 Openings (1Year)
Web Software	iTEC OnHospitality iTEC OnAccessPRO iTEC Hybrid
Windows Software	iTEC iOA
APP's	IOS 8; Android 5; or earlier
Compatibility	Yes
Stand Alone	IP44
IP	1,82 Kg
Weight	30%-95%
Humidity Resistance	-20°C~+55°C
Temp. of Operation	Unlimited
Code No. via APP	60
Self-defined Code No.	60
Fingerprint Number	100
IC card number	Yes
User Levels	Yes
Management Code	Yes
Available Colors	Black, Chrome, Stainless
Installation	Residences, Apartments, Hostels, Offices, AIRBNB, Hotels
Door thickness	10mm~12mm

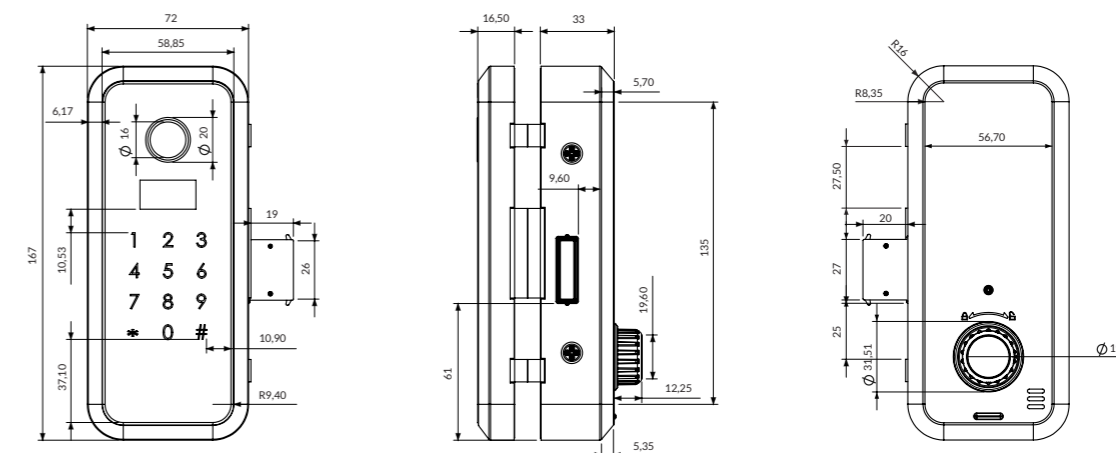
**es.**

Material	Aleación, Inoxidable, Acrílico
Método de apertura	Huella digital, Código, Tarjeta, Wifi, BLE, APLICACIÓN, Mando
Tiempo de identificación	<5,0S
Comunicación	Bluetooth 4.1 Mifare (13,56 MHz)
Teclado	Sí
Bombillo	N/A
Tipo de cerraduras	Modelo propio
Voltaje	Micro USB
Apertura de emergencia	Llave mecánica
Duración de la batería	CC 6 V (AA * 4)
Energía máxima	6V-MAX
Duración de la Bateria	~ 12 meses Admite ~ 5,000 operaciones
Leds	Verde, Rojo
Alarma de batería baja	En la aplicación y alarma por voz
Consumo	<200 mA
Consumo estático	65µA
Tiempo Aberto	16 años; 10 s; 15S; 30 años; Años 60; personalizado
Numero de aperturas	~ 2500 aperturas (1 año)
Software Web	iTEC OnHospitality iTEC OnAccessPRO
Software de Windows	iTEC Hybrid
Aplicaciones	iTEC iOA
Compatibilidad	IOS 8; Android 5; o superior
Stand Alone	Sí
IP	IP44
Peso	1,82 kilogramos
Resistencia a la humedad	30% -95%
Temperatura. de operación	-20°C ~ + 55°C
No. de código via APP	Ilimitado
No. Código autodefinido	60
Número de huella digital	60
Número de tarjeta IC	100
Niveles de usuario	sí
Código de gestión	sí
Colores disponibles	Negro, cromo, inoxidable
Instalación	Residencias, Apartamentos, Hostales, Oficinas, AIRBNB, Hoteles
Espesor de puerta	10 mm ~ 12 mm

fr.

Matériel	Alliage, acier inoxydable, acrylique
Méthode d'ouverture	Empreinte digitale, Code, Carte, Wifi, BLE, APP, Commander
Méthode d'ouverture	<5,0S
Temps d'identification	Bluetooth 4.1-Mifare (13,56 MHz)
Clavier	Oui
Cylindre	N/A
Compatibilité avec les serrures	Propre modèle
Ouverture d'urgence	Micro USB
Alimentation de secours	Clé mécanique
Max. Puissance	DC 6 v (AA * 4)
Vie de la batterie	6V-MAX
Max. Puissance	~ 12 mois
Vie de la batterie	Prend en charge environ 5000 opérations d'ouverture et de fermeture
Leds	Vert, Rouge
Alarme de batterie faible	Dans l'application et l'alarme vocale
Consumption statique	En dessous de 4,8V
Consumation	<200 mA
Temps ouvert	65µA
Nombre d'ouvertures	16s; 10s; 15S; 30s; 60s; Douane
Logiciel Web	~ 2500 ouvertures (1 an)
Logiciel Windows	iTEC OnHospitality iTEC OnAccessPRO
Applications	iTEC Hybrid
Compatibilité	iTEC iOA
Autonome	IOS 8; Android 5; ou supérieur
IP	Oui
Poids	IP44
Résistance à l'humidité	1,82 kilogrammes
Temp. De fonctionnement	30% -95%
N ° de code via APP	-20 ° C à + 55 ° C
N ° de code auto-défini	Ilimité
Numéro d'empreinte digitale	60
Numéro de carte IC	60
Niveaux d'utilisateurs	100
Code de gestion	Oui
Couleurs disponibles	Oui
Installation	Noir, Chrome, Inoxydable
Épaisseur de la porte	Residencias, appartements, auberges, bureaux, AIRBNB, hôtels
	10 mm à 12 mm



Standalone
RFID

ABS

ZZA

4x
AAA

CE

IP65



pt. iTetra é uma solução de fechadura vertical de acesso por código PIN. É uma versão mais económica nesta gama de fechaduras. A sua aparência robusta possui um corpo principal com teclado de 10 dígitos e um corpo secundário, uma extrusão para as teclas.

en. iTetra is a PIN code access vertical lock solution, it is a more economical version in this range of locks. Its robust appearance has a main body with a 10-digit keyboard, and a secondary body, an extrusion for the keys.

es. iTetra es una solución de bloqueo de acceso con código PIN vertical, es una versión más económica en esta gama de bloqueos. Su apariencia robusta tiene un cuerpo principal con un teclado de 10 dígitos y un cuerpo secundario, una extrusión para las teclas.

fr. iTetra est une solution de serrure verticale d'accès par code PIN, c'est une version plus économique dans cette gamme de serrures. Son apparence robuste a un corps principal avec un clavier à 10 chiffres et un corps secondaire, une extrusion pour les touches.



Ficha Técnica | Datasheet | Hoja Técnica | Fiche Technique

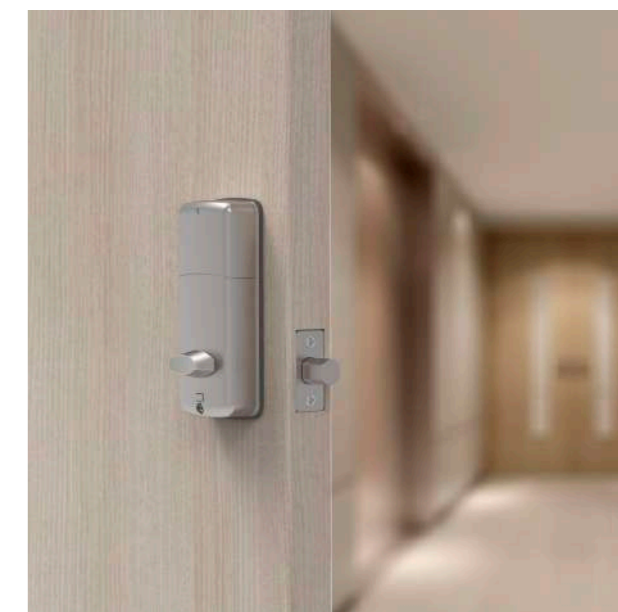
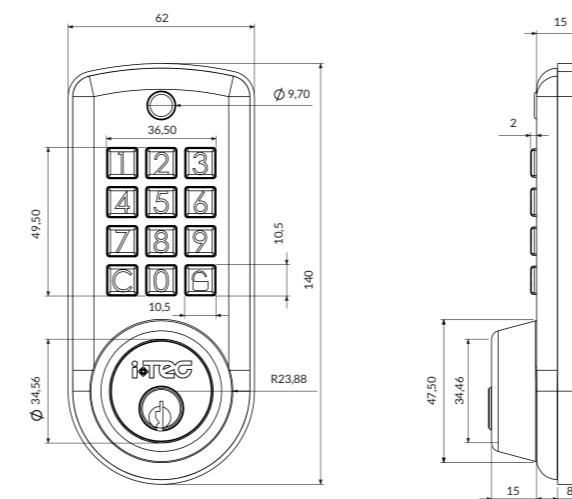

pt.

Material	Liga de Zinco
Tecnologia	Código PIN
Método de Abertura	Pin + Chave
Abertura de Emergência	Chave Mecânica
Potência	DC 6v (AAA*4)
Vida Útil da Bateria	~12 meses
Leds	Azul e Vermelho
Alarme de Bateria Fraca	3 Longos BIP
Consumo	350mA
Consumo Estático	15µA
Tempo Aberto	7s
Número de Aberturas	~5000 Aberturas (1Ano)
Stand Alone	Sim
Peso	1,2 Kg
Espessura da Porta	38mm - 48mm
Password	4 - 8 Dígitos

en.

Material	Zinc Alloy
Technology	Pincode
Opening Method	Pin + Key
Cylinder	Euro Cylinder
Emergency Open	Mechanical Key
Power	DC 6v (AAA*4)
Battery Lifetime	~12 months
Leds	Blue and Red
Low Battery Alarm	3 Long tick before operation
Driving Consumption	350mA
Static Consumption	15µA
Open Time	7s
Number of openings	~5000 Openings (1Year)
Stand Alone	Yes
Weight	1,2 Kg
Door Thickness	38mm - 48mm
Password	4 - 8 Digits

es.

Material	Aleación de zinc
Tecnología	Código PIN
Método de apertura	PIN + Llave
Cilindro	Cilindro europeo
Apertura de emergencia	Llave mecánica
Poder	DC 6v (AAA * 4)
Duración de la batería	~ 12 meses
Leds	Azul y rojo
Alarma de batería baja	3 BIP largos
El consumo	350mA
Consumo Estático	15µA
Tiempo abierto	7s
Numero de aperturas	~ 5000 aperturas (1 año)
Stand Alone	Sim
Peso	1,2 Kg
Espesor de puerta	38mm - 48mm
Contraseña	4 - 8 Dígitos

fr.

Matériel	Alliage de zinc
La technologie	Code PIN
Méthode d'ouverture	Pin + Clé
Cylindre	Cylindre européen
Ouverture d'urgence	Clé mécanique
Pouvoir	DC 6v (AAA * 4)
Vie de la batterie	~ 12 mois
Leds	Bleu et rouge
Alarme de batterie faible	3 long BIP
La consommation	350mA
Consommation statique	15µA
Temps ouvert	7s
Nombre d'ouvertures	~ 5000 ouvertures (1 an)
Stand Alone	Sim
Poids	1,2 Kg
Épaisseur de la porte	38mm - 48mm
Mot de passe	4 - 8 Chiffres

iKeypad01®



iKeypad02®



MTL

GLS



CE

IP65

pt. O iKeypad01 é um leitor de parede de controlo de acesso, aberto por dispositivo móvel, código PIN ou cartão RFID. Com o iTEC OnAccess, o iKeypad funciona como sistema Wi-Fi através do gateway e do APP, permitindo conceder e bloquear o acesso a partir de qualquer lugar.

en. iKeypad01 is an access control wall reader, opened by mobile device, PIN code or RFID card. With iTEC OnAccess, iKeypad works as a Wi-Fi system through the gateway and APP, allowing you to grant and block access from anywhere.

es. iKeypad01 es un lector de pared de control de acceso, abierto por dispositivo móvil, código PIN o tarjeta RFID. Con iTEC OnAccess, el iKeypad funciona como un sistema Wi-Fi a través de la puerta de enlace y la aplicación, le permite conceder y bloquear el acceso desde cualquier lugar.

fr. iKeypad01 est un lecteur mural de contrôle d'accès, ouvert par un appareil mobile, un code PIN ou une carte RFID. Avec iTEC OnAccess, iKeypad fonctionne comme un système Wi-Fi via la passerelle et l'APP, vous permettant d'accorder et de bloquer l'accès depuis n'importe où.

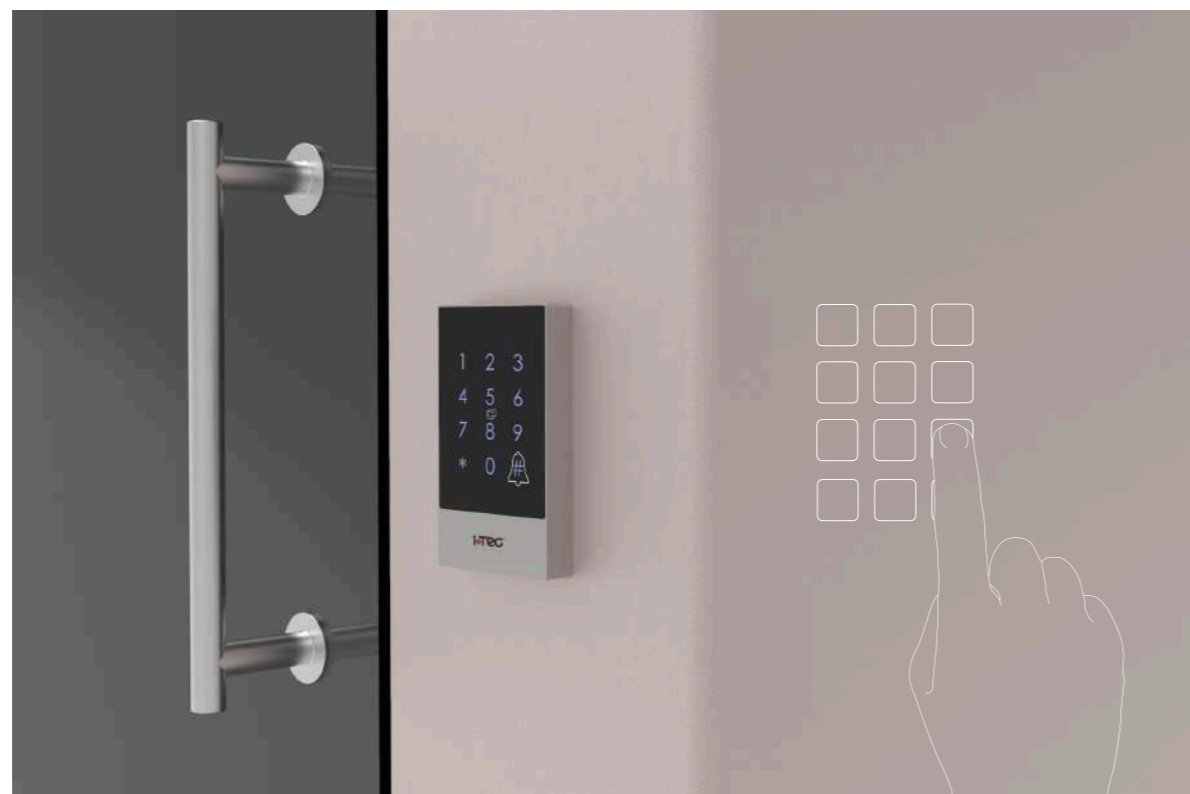

MTL

GLS



CE

IP65

pt. O iKeypad02 é um leitor de parede de controlo de acesso, aberto por dispositivo móvel, cartão RFID, código PIN ou por impressão digital. Com o iTEC OnAccess, o iKeypad funciona como sistema Wi-Fi através do gateway e do APP, permitindo conceder e bloquear o acesso a partir de qualquer lugar.

en. iKeypad02 is an access control wall reader, opened by mobile device, RFID card, PIN code or by fingerprint. With iTEC OnAccess, iKeypad works as a Wi-Fi system through the gateway and APP, allowing you to grant and block access from anywhere.

es. iKeypad02 es un lector de pared de control de acceso, abierto por dispositivo móvil, tarjeta RFID, código PIN o huella dactilar. Con iTEC OnAccess, el iKeypad funciona como un sistema Wi-Fi a través de la puerta de enlace y la aplicación, le permite conceder y bloquear el acceso desde cualquier lugar.

fr. iKeypad02 est un lecteur mural de contrôle d'accès, ouvert par appareil mobile, carte RFID, code PIN ou par empreinte digitale. Avec iTEC OnAccess, iKeypad fonctionne comme un système Wi-Fi via la passerelle et l'APP, vous permettant d'accorder et de bloquer l'accès depuis n'importe où.



iKeypad01® | iKeypad02®

Ficha Técnica

Datasheet

Hoja Técnica

Fiche Technique

O iKeypad 2.0® é igual ao iKeypad®, com o acréscimo de abertura através de impressão digital.
The iKeypad 2.0® is the same of the iKeypad®, with the addition of fingerprint opening.
El iKeypad 2.0® es igual que el iKeypad®, con la adición de la apertura de huellas dactilares.
L'iKeypad 2.0® est le même que l'iKeypad®, avec l'addition de l'ouverture des empreintes digitales.

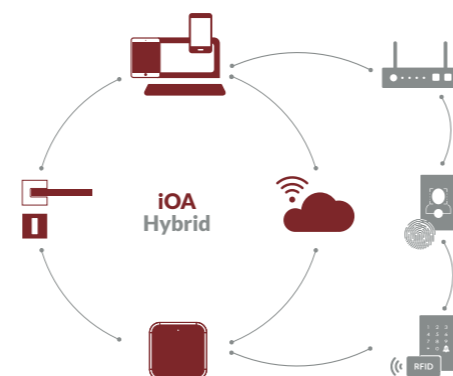

pt.

Material	Liga Metálica; Vidro
Método de Abertura	Código, Cartão, Wifi, BLE, APP, Comando, Impressão Digital
Tempo de Identificação	<1.5S
Comunicação	Bluetooth 4.1
Cilindro	N/A
Compatibilidade com fechaduras	Dispositivos eléctricos
Energia de Emergência	N/A
Abertura de Emergência	N/A
Potência	DC 12 V
Máx. Potência	12V-MAX
Vida Útil da Bateria	N/A
Leds	Azul
Alarme de Bateria Fraca	N/A
Consumo	2 A
Consumo Estático	5 mA
Tempo Aberto	5s; 10s; 15s; 30s; 60s; personalizado
Software Web	iTEC OnHospitality iTEC OnAccessPRO
Software Windows	iTEC Hybrid
APP's	iTEC iOA
Compatibilidade	IOS 8 e superior
Stand Alone	Android 5 e superior
IP	IP67
Peso	1,2 Kgs
Resistencia à Humidade	10%-95%
Temp. de Funcionamento	-20°C~+70°C
Nº de Código via APP	Ilimitado
Nº de Cód. auto-definido	Ilimitado
Nº de Impressão Digital	Ilimitado
Nº de cartões de IC	Ilimitado
Níveis de Usuários	Sim
Código de Gestão	Sim
Cores Disponíveis	Negro, Cinza
Instalação	Apartamentos, Residenciais, Escritórios, AIRBNB, Hotéis
Espessura de porta	N/A

en.

Material	Alloy; Glass
Opening Method	Code, Card, Wifi, BLE, APP, Command, Fingerprint
Identification Time	<1.5S
Communication	Bluetooth 4.1
Cylinder	N/A
Compatibility with locks	Electrical devices
Emergency Power	N/A
Emergency Opening	N/A
Voltage	DC 12 V
Max. Power	12V-MAX
Battery Life	N/A
Leds	Blue
Low Battery Alarm	N/A
Static Consumption	5 mA
Time Open	5s; 10s; 15s; 30s; 60s; custom
Web Software	iTEC OnHospitality iTEC OnAccessPRO
Windows Software	iTEC Hybrid
APP's	iTEC iOA
Compatibility	IOS 8 or erlier
Stand Alone	Android 5 or erlier
IP	IP67
Weight	1,2 Kgs
Humidity Resistance	10%-95%
Temp. of Operation	-20°C~+70°C
Code No. via APP	Unlimited
Self-defined Code No.	Unlimited
Fingerprint Number	Unlimited
IC card number	Unlimited
User Levels	Yes
Management Code	Yes
Available Colors	Black, Grey
Installation	Residences, Apartments, Hostels, Offices, AIRBNB, Hotels
Door thickness	N/A

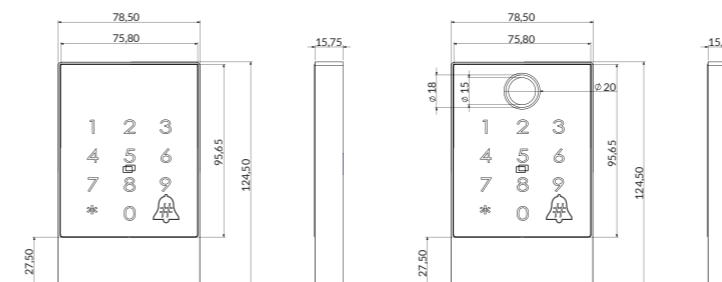

es.

Material	Aleación; Vidrio
Método de apertura	Código, Tarjeta, Wifi, BLE, APLICACIÓN, Mando, Huella Digital
Tiempo de identificación	<1,5 S
Comunicación	Bluetooth 4.1
Bombillo	N/A
Tipo de cerraduras	Aparatos eléctricos
Voltaje	N/A
Apertura de emergencia	N/A
Duración de la batería	CC 12 V
Energía máxima	12V-MAX
Duración de la Bateria	N/A
Leds	Azul
Alarma de batería baja	N/A
Consumo	2 A
Consumo estático	5 mA
Tiempo Aberto	5s; 10s; 15s; 30s; 60s; personalizado
Numero de aperturas	iTEC OnHospitality iTEC OnAccessPRO
Software Web	iTEC Hybrid
Software de Windows	iTEC iOA
Aplicaciones	IOS 8 o superior
Compatibilidad	Android 5 o superior
Stand Alone	N/A
IP	IP67
Peso	1,2 kilogramos
Resistencia a la humedad	10% -95%
Temperatura. de operación	-20°C ~ + 70°C
No. de código vía APP	Ilimitado
No. Código autodefinido	Ilimitado
Número de huella digital	Ilimitado
Número de tarjeta IC	Ilimitado
Niveles de usuario	Sí
Código de gestión	Sí
Colores disponibles	Gris oscuro
Instalación	Residencias, Apartamentos, Hostales, Oficinas, AIRBNB, Hoteles
Espesor de puerta	N/A

fr.

Matériel	Alliage; Un verre
Méthode d'ouverture	Code. Carte. Wifi. BLE. APP. Commander. D'empreinte Digitale
Temps d'identification	<1,5 S
Communication	Bluetooth 4.1
Cylindre	N/A
Compatibilité avec les serrures	Appareils électriques
Ouverture d'urgence	N/A
Alimentation de secours	N/A
Tension	12 V CC
Max. Puissance	12V-MAX
Vie de la batterie	N/A
Leds	Bleu
Alarme de batterie faible	N/A
Consommation statique	2 A
Consommation	5 mA
Temps ouvert	5s; 10s; 15s; 30s; 60s; Douane
Logiciel Web	iTEC OnHospitality
Logiciel Windows	iTEC OnAccessPRO
Applications	iTEC Hybrid
Compatibilité	iTEC iOA
Autonome	IOS 8 e supérieur
IP	Android 5 e supérieur
Poids	IP67
Résistance à l'humidité	1,2 kilogrammes
Temp. De fonctionnement	10% -95%
N ° de code via APP	-20 ° C à + 70 ° C
N ° de code auto-défini	Ilimité
Numéro d'empreinte digitale	Ilimité
Numéro de carte IC	Ilimité
Niveaux d'utilisateurs	Oui
Code de gestion	Oui
Couleurs disponibles	Gris noir
Installation	Résidences, appartements, auberges, bureaux, AIRBNB, hôtels
Épaisseur de la porte	N/A

iKeypad03[®]

pt. O iKeypad03 é um periférico prático que combina com todos os tipos de fechaduras monitorizadas por iTEC OnAccess. Apresenta um corpo em plástico ABS, munido de botões de pressão onde se pode inserir o código para abertura do sistema de controlo de acesso atribuído. Com este teclado é possível um controlo bidirecional e intuitivo.

en. iKeypad03 is a practical peripheral that matches all types of locks monitored by iTEC OnAccess. It has an ABS plastic body, equipped with push buttons where you can enter the code to open the assigned access control system. With this keyboard it is possible a bidirectional and intuitive control.

es. iKeypad03 es un práctico periférico que combina con todo tipo de cerraduras monitoreadas por iTEC OnAccess. Tiene un cuerpo de plástico ABS, equipado con pulsadores donde se puede introducir el código para abrir el sistema de control de acceso asignado. Con este teclado es posible un control bidireccional e intuitivo.

fr. iKeypad03 est un périphérique pratique qui s'adapte à tous les types de serrures surveillées par iTEC OnAccess. Il a un corps en plastique ABS, équipé de boutons poussoirs où vous pouvez entrer le code pour ouvrir le système de contrôle d'accès attribué. Avec ce clavier, il est possible un contrôle bidirectionnel et intuitif.

iKSB01[®]

pt. O cofre iKSB01 é gerido pela solução iTEC OnAccess e via wifi. Desenvolvido para aplicabilidade em hotéis sem receção, apartamentos turísticos, AIRBNB, etc., permite guardar e partilhar chaves mecânicas, cartões RFID ou outros pequenos objetos a partir da sua pequena cavidade, acessível após a sua abertura.

en. The iKSB01 safe is managed by the iTEC OnAccess solution and via wifi. Developed for use in hotels without reception, tourist apartments, AIRBNB, etc., it allows storing and sharing mechanical keys, RFID cards or other small objects from its small cavity, accessible after opening.

es. La caja fuerte iKSB01 se gestiona mediante la solución iTEC OnAccess y vía wifi. Desarrollado para su uso en hoteles sin recepción, apartamentos turísticos, AIRBNB, etc., permite guardar y compartir llaves mecánicas, tarjetas RFID u otros pequeños objetos desde su pequeña cavidad, accesible tras su apertura.

fr. Le coffre iKSB01 est géré par la solution iTEC OnAccess et via le wifi. Développé pour une utilisation dans les hôtels sans réception, appartements touristiques, AIRBNB, etc., il permet de stocker et de partager des clés mécaniques, des cartes RFID ou d'autres petits objets depuis sa petite cavité, accessible après ouverture.

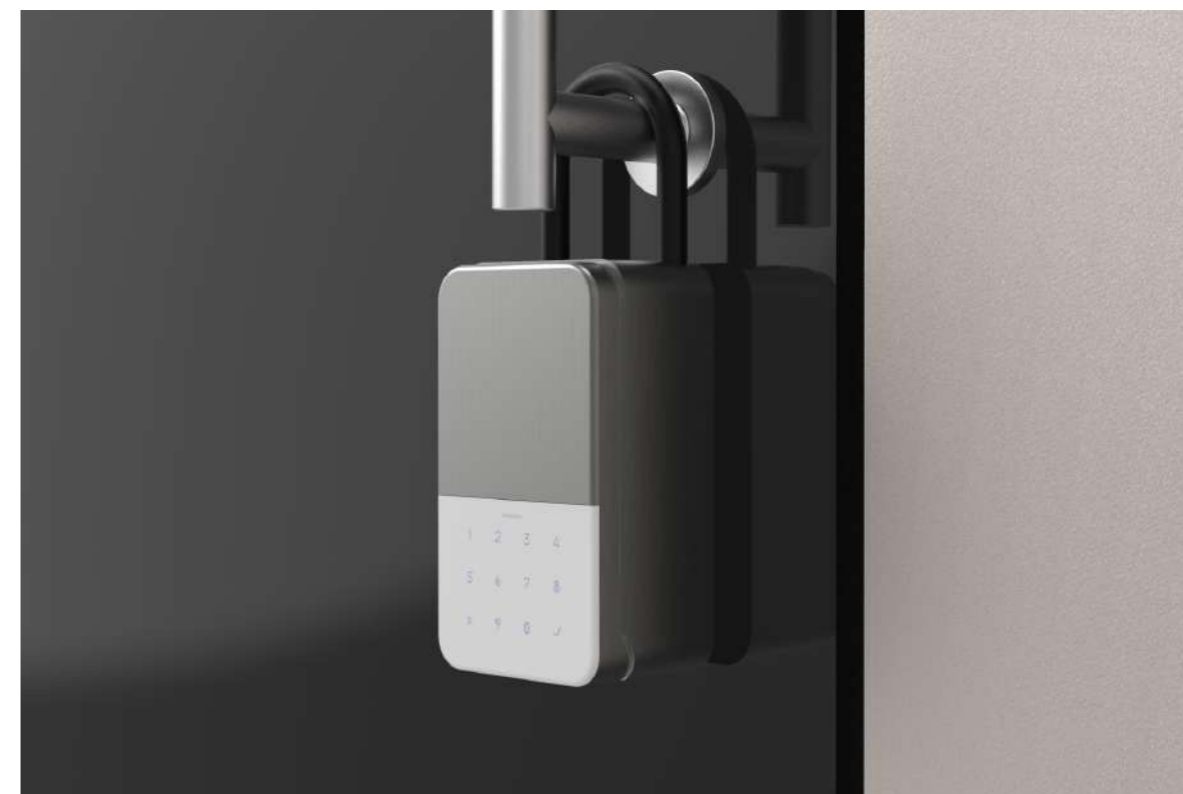

iKeypad03®

Ficha Técnica

Datasheet

Hoja Técnica

Fiche Technique

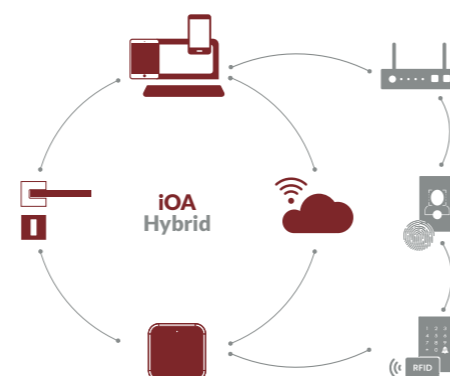

pt.		en.	
Material	ABS	Material	ABS
Método de abertura	Código PIN, APP	Opening Method	PINCode, APP
Dimensões	67.7mm*96.3mm*29.9mm	Dimensions	67.7mm*96.3mm*29.9mm
Comunicação	Bluetooth 4.1	Communication	Bluetooth 4.1
Teclado	Sim	Keypad	Yes
Tensão	6 volts	Voltage	6 volts
Fonte de energia	4xAAA	Power Supply	4xAAA
Leds	Verde, vermelho	Leds	Green, Red
Software Web	iTEC OnHospitalidade iTEC OnAccessPRO	Web Software	iTEC OnHospitality iTEC OnAccessPRO
Software Windows	iTEC Híbrido	Windows Software	iTEC Hybrid
APP's	iTEC iOA	APP's	iTEC iOA
Compatibilidade	IOS 8; Android 5; ou superior	Compatibility	IOS 8; Android 5; or superior
IP	IP54	IP	IP54
Peso	0,150Kg	Weight	0.150Kg
Resistência à Humidade	40%-80%	Humidity Resistance	40%-80%
Temp. de operação	-10°C~+55°C	Temp. of Operation	-10°C~+55°C
Código nº via APP	Ilimitado	Code No. via APP	Unlimited
Código de gestão	Sim	Management Code	Yes
Cores disponíveis	Preto	Available Colors	Black

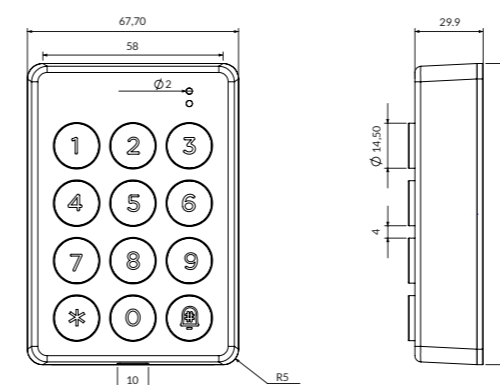

es.		fr.	
Material	ABS	Matériel	Aleación de aluminium
Método de apertura	Código PIN, Aplicación	Méthode d'ouverture	Código PIN, APLICACIÓN
Dimensiones	67.7 mm*96.3mm*29.9 mm	Dimensions	67.7mm*96.3mm*29.9mm
Comunicación	Bluetooth 4.1	Communication	Bluetooth 4.1
Teclado	Sí	Teclado	Si
Voltaje	6 voltios	Tension	6 volts
Fuente de alimentación	4xAAA	Source d'alimentation	4xAAA
LED	Verde, Rojo	LED	Vert, Rojo
Software web	iTEC en Hospitalidad iTEC OnAccessPRO	Logiciel web	iTEC en Hospitalité iTEC OnAccessPRO
Software de windows	Híbrido iTEC	Logiciel de windows	Hybride iTEC
APLICACIONES	iTEC iOA	APPLICATIONS	iTEC iOA
Compatibilidad	IOS 8; android 5; o mayor	Compatibilité	iOS 8 ; Android 5 ; Ô maire
IP	IP54	IP	IP54
Peso	0.150Kg	Peso	0.150Kg
Resistencia a la humedad	40%-80%	Résistance à la humedad	40%-80%
Temperatura. de operación	-10°C~+55°C	Température. de fonctionne- ment	-10°C~+55°C
Número de código a través de la aplicación	Ilimitado	Número de código a través de la aplicación	Illimité
Código de gestión	Sí	Code de gestion	Si
Colores disponibles	Negro	Couleurs disponibles	Noir

iKSB01®**Ficha Técnica**

Datasheet

Hoja Técnica

Fiche Technique

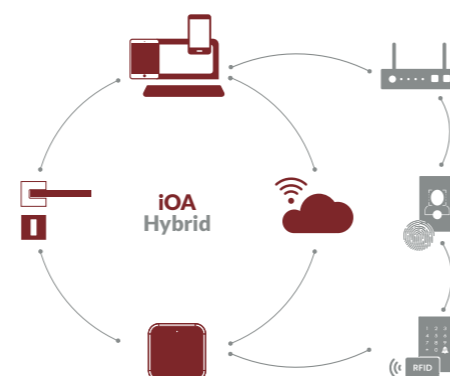

pt.		en.	
Material	Liga de alumínio	Material	Aluminum Alloy
Método de abertura	Código PIN, APP	Opening Method	PINCode, APP
Dimensões	73mm*123mm*50.6mm	Dimensions	73mm*123mm*50.6mm
Espaço de armazenamento	63mm*98mm*25mm	Storage Space	63mm*98mm*25mm
Comunicação	Bluetooth 4.1, Wi-Fi	Communication	Bluetooth 4.1, WIFI
Teclado	Sim	Keypad	Yes
Tensão	4,5 volts	Voltage	4.5 volts
Fonte de energia	3xAAA	Power Supply	3xAAA
Leds	Azul, verde, vermelho	Leds	Blue, Green, Red
Software Web	iTEC OnHospitalidade iTEC OnAccessPRO	Web Software	iTEC OnHospitality iTEC OnAccessPRO
Software Windows	iTEC Híbrido	Windows Software	iTEC Hybrid
APP's	iTEC iOA	APP's	iTEC iOA
Compatibilidade	IOS 8; Android 5; ou mais	Compatability	IOS 8; Android 5; or older
IP	IP54	IP	IP54
Peso	0,600Kg	Weight	0.600Kg
Resistência à Humidade	40%-80%	Humidity Resistance	40%-80%
Temp. de operação	-10°C~+55°C	Temp. of Operation	-10°C~+55°C
Código n° via APP	Ilimitado	Code No. via APP	Unlimited
Código de gestão	Sim	Management Code	Yes
Cores disponíveis	Inoxidável	Available Colors	Stainless

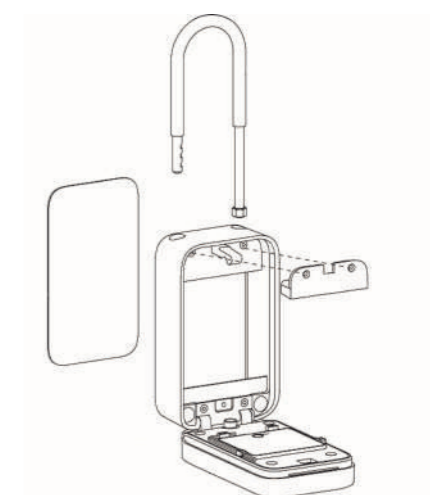
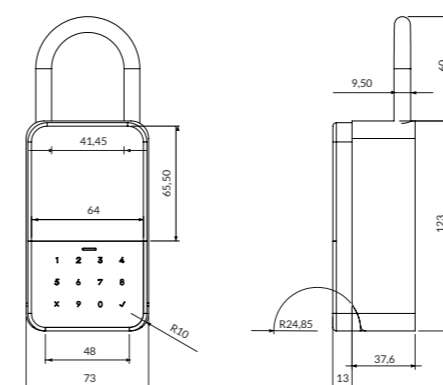

es.		fr.	
Material	Aleación de aluminio	Matériel	Aleación de aluminium
Método de apertura	Código PIN, APLICACIÓN	Méthode d'ouverture	Código PIN, APLICACIÓN
Dimensiones	73 mm * 123 mm * 50,6 mm	Dimensions	73mm * 123mm * 50,6mm
Espacio de almacenamiento	63mm*98mm*25mm	Espace de l'almacenamiento	63mm*98mm*25mm
Comunicación	Bluetooth 4.1 wifi	Communication	Wi-Fi Bluetooth 4.1
Teclado	Sí	Teclado	Si
Voltaje	4,5 voltios	Tension	4,5 volts
Fuente de alimentación	3xAAA	Source d'alimentation	3xAAA
LED	Azul, Verde, Rojo	LED	Azul, Vert, Rojo
Software web	iTEC en Hospitalidad iTEC OnAccessPRO	Logiciel web	iTEC en Hospitalité iTEC OnAccessPRO
Software de windows	Híbrido iTEC	Logiciel de windows	Hybride iTEC
APLICACIONES	iTEC iOA	APPLICATIONS	iTEC iOA
Compatibilidad	IOS 8; android 5; o mayor	Compatibilité	IOS 8 ; Android 5 ; Ô maire
IP	IP54	IP	IP54
Peso	0.600Kg	Peso	0,600Kg
Resistencia a la humedad	40%-80%	Résistance à la humidad	40%-80%
Temperatura de operación	-10°C~+55°C	Température de fonctionnement	-10°C~+55°C
Número de código a través de la aplicación	Ilimitado	Número de código a través de la aplicación	Illimité
Código de gestión	Sí	Code de gestion	Si
Colores disponibles	Inoxidable	Couleurs disponibles	Inoxydable

WR 02[®]

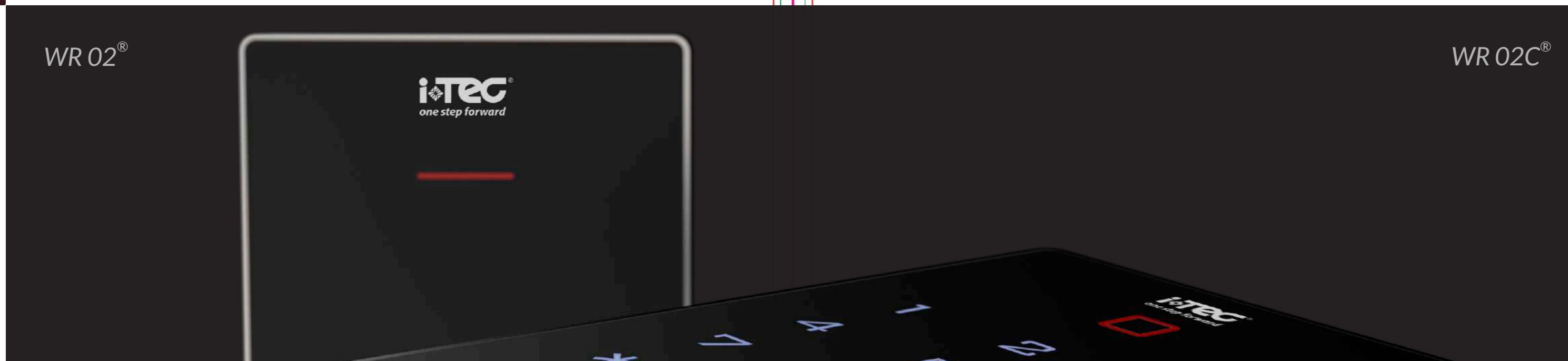
WR 02C[®]

MTL

GLS

CE

IP67

pt. O WR 02 é um controlo de acesso multifuncional com teclado ou leitor RFID (MF 13,56 Mhz) via protocolo Wiegand. Possui um microprocessador integrado que torna o produto à prova de congestionamento, seguro e confiável. É adequado para montagem em ambientes internos ou externos.

en. WR 02 is a multifunctional access control with a keyboard or RFID reader (MF 13.56 Mhz) via Wiegand protocol. It has a built-in microprocessor that makes the unit jam-proof, safe and reliable. It is suitable for mounting indoors or outdoors.

es. WR 02 es un control de acceso multifuncional con teclado o lector RFID (MF 13.56 Mhz) vía protocolo Wiegand. Tiene un microprocesador incorporado que hace que la unidad sea a prueba de atascos, segura y confiable. Es adecuado para el montaje en interiores o exteriores.

fr. WR 02 est un contrôle d'accès multifonctionnel avec un clavier ou un lecteur RFID (MF 13.56 Mhz) via le protocole Wiegand. Il dispose d'un microprocesseur intégré qui rend l'unité anti-blocage, sûre et fiable. Il convient pour un montage à l'intérieur ou à l'extérieur.

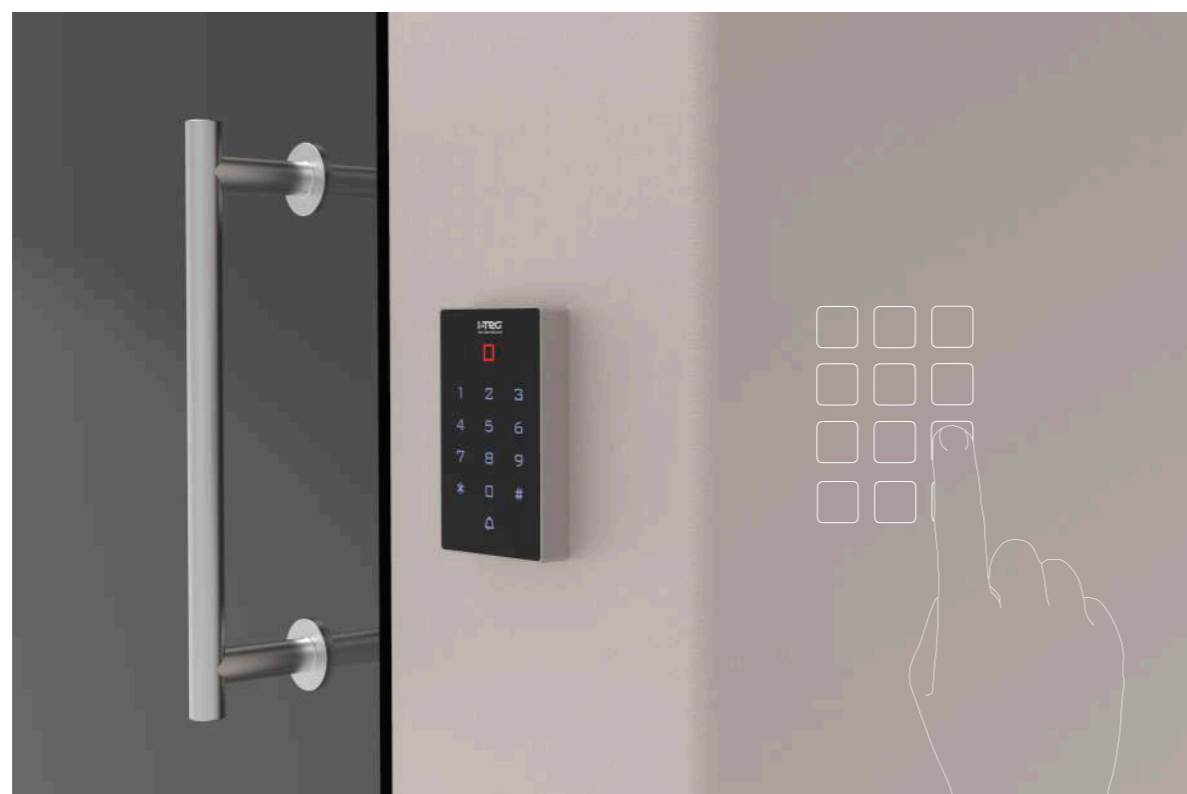

pt. O WR 02C é uma nova geração de controlo de acesso multifuncional "Standalone". Com microprocessador de núcleo ARM de 32 bits, torna-o mais estável e confiável. Inclui modo de leitura e modo de controlo de acesso "autónomo".

en. WR 02C is a new generation of multifunctional "Standalone" access control. With 32-bit ARM core microprocessor, it makes it more stable and reliable. Includes reader mode and "Standalone" access control mode.

es. WR 02C es una nueva generación de control de acceso multifuncional "Autónomo". Con microprocesador de núcleo ARM de 32 bits, lo hace más estable y confiable. Incluye modo de lector y modo de control de acceso "Autónomo".

fr. WR 02C est une nouvelle génération de contrôle d'accès multifonctionnel "Standalone". Avec le microprocesseur central ARM 32 bits, il le rend plus stable et fiable. Inclut le mode lecteur et le mode de contrôle d'accès "Standalone".



MTL

GLS

CE

IP67

WR 02[®] WR 02C[®]

Ficha Técnica

Datasheet

Hoja Técnica

Fiche Technique

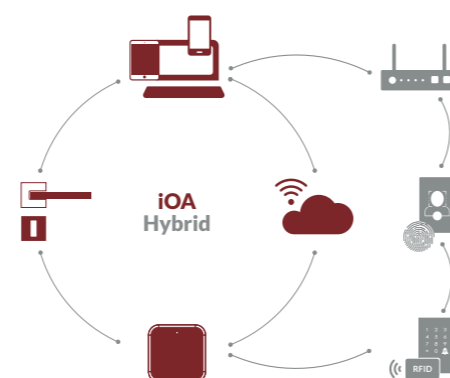
**pt.****iWR**

Material	ABS
Tipo de cartão	MF
Frequência	13.56 Mhz
Capacidade de utilizadores	2.000 utilizadores
Voltagem	DC12V
Faixa de leitura	3-6cm
Wiengand 26	Saída e entrada
Tempo de abertura	0-99s (ajustável)
Dimensão	114*74*16

iRFID Reader

Material	ABS
Tipo de cartão	MF
Frequência	13.56 Mhz
Capacidade de utilizadores	10.000 utilizadores
Voltagem	DC12V
Corrente em standby	≤ 35mA
Corrente em operação	≤ 10mA
Máx. corrente nominal	≤ 1A
Temperatura	-20°C ~ 60°C
Humidade	0% ~ 95%
Faixa de leitura	3-6cm
Wiengand 26	Saída e entrada
Tempo de abertura	0-99s (ajustável)
Dimensão	114*74*16

en.**iWR**

Material	ABS
Card type	MF
Frequency	13.56 Mhz
Capacity of users	2,000 users
Voltage	DC12V
Reading range	3-6cm
Wiengand 26	Exit and entry
Opening time	0-99s (adjustable)
Dimension	114*74*16

iRFID Reader

Material	ABS
Card type	MF
Frequency	13.56 Mhz
Capacity of users	10,000 users
Voltage	DC12V
Standby current	≤ 35mA
Current in operation	≤ 10mA
Max. rated current	≤ 1A
Temperature	-20°C ~ 60°C
Humidity	0% ~ 95%
Reading range	3-6cm
Wiengand 26	Exit and entry
Opening time	0-99s (adjustable)
Dimension	114*74*16

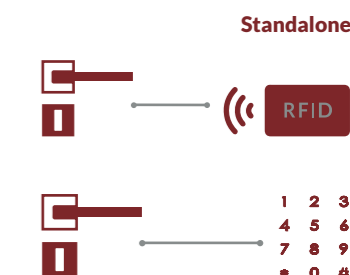
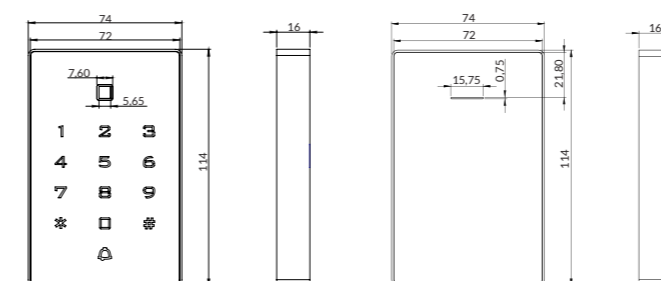
**es.****iWR**

Material	ABS
Tipo de tarjeta	FM
Frecuencia	13,56 Mhz
Capacidad de los usuarios	2000 usuarios
Voltaje	CC12V
Rango de lectura	3-6cm
Wiengand 26	Salida y entrada
Hora de apertura	0-99s (ajustable)
Dimensión	114*74*16

iRFID Reader

Material	ABS
Tipo de tarjeta	FM
Frecuencia	13,56 Mhz
Capacidad de los usuarios	10.000 usuarios
Voltaje	CC12V
Corriente de espera	≤ 35mA
Corriente en funcionamiento	≤ 10mA
Corriente nominal máx.	≤ 1A
Temperatura	-20°C ~ 60°C
Humedad	0% ~ 95%
Rango de lectura	3-6cm
Wiengand 26	salida y entrada
Hora de apertura	0-99s (ajustable)
Dimensión	114*74*16

fr.**iWR**

Matériel	ABS
Type de carte	FM
La fréquence	13,56 Mhz
Capacité utilisateur	2000 utilisateurs
Tension	DC12V
Plage de lecture	3-6cm
Vienne 26	Sortie et entrée
Horaire d'ouverture	0-99s (réglable)
Dimension	114*74*16

iRFID Reader

Matériel	ABS
Type de carte	FM
La fréquence	13,56 Mhz
Capacité utilisateur	10 000 utilisateurs
Tension	DC12V
Courant de veille	35mA
Courant de fonctionnement	10mA
Courant nominal max.	1A
Température	-20°C ~ 60°C
Humidité	0% ~ 95%
Plage de lecture	3-6cm
Vienne 26	sortie et entrée
Horaire d'ouverture	0-99s (réglable)
Dimension	114*74*16

Gateway iOA® | Gateway Rj45®



ABS



IP44



pt. A Gateway iOA do iTEC OnAccess é o que torna possível o acesso remoto aos terminais, apesar de ser viável usar o iTEC OnAccess sem Gateway, pois as funcionalidades estão limitadas à distância de Bluetooth. A Gateway iOA torna possível qualquer funcionalidade a partir de qualquer parte do mundo.

en. iTEC OnAccess Gateway iOA is what makes remote access to terminals possible, although using iTEC OnAccess without Gateway is feasible, features are limited to the Bluetooth distance, with Gateway iOA making any functionality possible from anywhere of the world.

es. iTEC OnAccess Gateway iOA es lo que hace posible el acceso remoto a terminales, aunque es factible usar iTEC OnAccess sin Gateway, las funciones están limitadas a la distancia Bluetooth, con Gateway iOA haciendo posible cualquier funcionalidad desde cualquier lugar del mundo.

fr. iTEC OnAccess Gateway iOA est ce qui rend possible l'accès au terminal distant. Bien que l'utilisation d'iTEC OnAccess sans Gateway iOA soit réalisable, les fonctionnalités se limitent à la distance Bluetooth, avec la passerelle rendant toute fonctionnalité possible de n'importe où du monde.

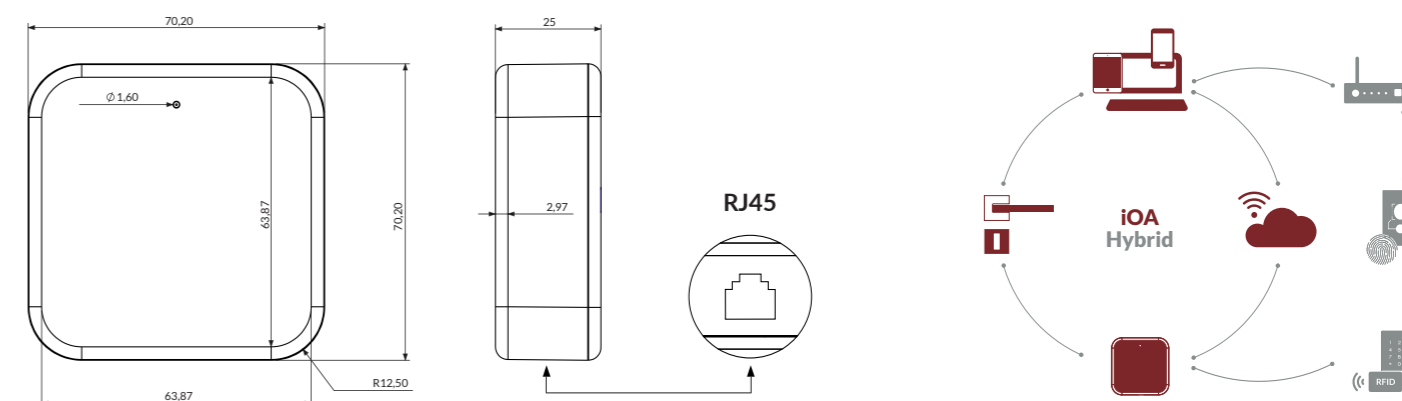

Ficha Técnica | Datasheet | Hoja Técnica | Fiche Technique

**pt.**

Material	ABS
Tecnologia	Wi-Fi 2.4G, Rj45
Potência	DC 5V
Leds	Azul e Vermelho
Consumo	350mA
Consumo Estático	15µA
Software Web	iTEC OnHospitality iTEC OnAccessPRO
Software Windows	iTEC Hybrid
APP's	iTEC iOA
Distância de Leitura	> 10m
Peso	0,2 Kg
Resistencia à Humidade	< 95%
Temp. de Trabalho	-20°C ~ +65°C
Temp. de Armazenamento	-40°C ~ +80°C
Entrada de Energia	DC 5V / 500mA
IEEE Standard	802.11 b / g / n
Interface de Alimentação	Type-C USB

es.

Material	ABS
Tecnología	WiFi 2.4G, Rj45
Poder	DC 5V
Leds	Azul es rojo
El consumo	350mA
Consumo Estático	15µA
Software Web	iTEC OnHospitality iTEC OnAccessPRO
Software de Windows	iTEC Hybrid
Aplicaciones	iTEC iOA
Distancia de lectura	> 10m
Peso	0,2 kg
Resistencia a la humedad	< 95%
Temp. de trabajo	-20°C ~ + 65°C
Temp. Almacenamiento	-40°C ~ + 80°C
Entrada de energía	DC 5V / 500mA
Norma IEEE	802.11 b / g / n
Interfaz de energía	USB tipo C

en.

Material	ABS
Technology	Wi-Fi 2.4G, Rj45
Power	DC 5V
Leds	Blue and red
Driving Consumption	350mA
Static Consumption	15µA
Web Software	iTEC OnHospitality iTEC OnAccessPRO
Windows Software	iTEC Hybrid
APP's	iTEC iOA
Reading Distance	> 10m
Weight	0,2 Kg
Resistance of Humidity	< 95%
Work Temperature	-20°C ~ +65°C
Storage Temperature	-40°C ~ +80°C
Power Input	DC 5V / 500mA
IEEE standard	802.11 b / g / n
Power Interface	Type-C USB

fr.

Matériel	ABS
La technologie	WiFi 2.4G, Rj45
Pouvoir	DC 5V
Leds	Bleu et rouge
La consommation	350mA
Consommation statique	15µA
Logiciel Web	iTEC OnHospitality iTEC OnAccessPRO
Logiciel Windows	iTEC Hybrid
Applications	iTEC iOA
Distance de lecture	> 10m
Le poids	0,2 kg
Résistance à l'humidité	< 95%
Temp. De travail	-20°C ~ + 65°C
Temp. Stockage	-40°C ~ + 80°C
Entrée de puissance	DC 5V / 500mA
Norme IEEE	802.11 b / g / n
Interface de puissance	USB de type C

iPin Reader®



ZZA



CE

IP65

WG

pt. O leitor de parede iPin Reader é projectado para uma variedade de situações, como controlo de acesso a uma área específica através de RFID ou por código Pin.

en. The iPin Reader wall reader is designed for a variety of situations, such as RFID or PIN code access control to a specific area.

es. El lector de pared iPin Reader está diseñado para una variedad de situaciones, como RFID o control de acceso con código PIN a un área específica.

fr. Le lecteur mural Pin Reader est conçu pour une variété de situations, telles que le contrôle d'accès RFID ou code PIN à une zone spécifique.

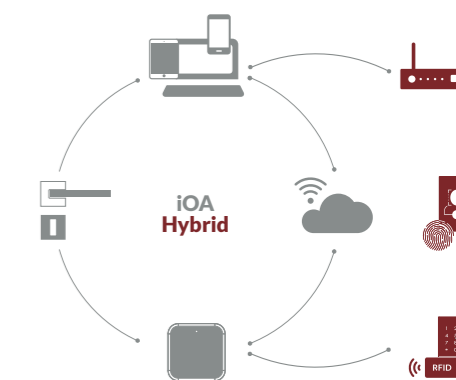
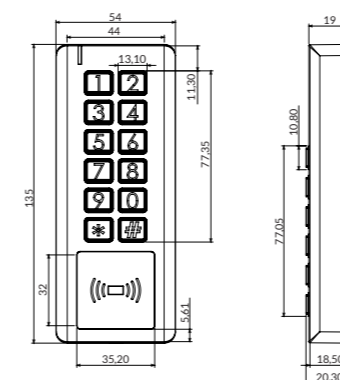

Ficha Técnica | Datasheet | Hoja Técnica | Fiche Technique

**pt.**

Material	Liga metálica
Tecnologia	Mifare® (Classic ISO/iEC 14443-4) WIFI - LAN
Método de Abertura	Proximidade, Cartão, Código
Potência	DC 12V
Leds	Azul
Consumo	< 35mA
Consumo Estático	6µA
Tempo Aberto	Regulável
Software	iTEC Hybrid
Stand Alone	Não (apenas Wiegand)
IP	IP 65
Distância de Leitura	≤ 55mm / Toque
Reconhecimento	0.5s
Peso	0,65 Kg
Resistencia à Humidade	< 95%
Temp. de Trabalho	-20°C ~ +65°C
Temp. de Armazenamento	-40°C ~ +80°C
Recolha de Dados	c/Software
Calendário	c/Software
Gravação de Registros	c/Software
Backup Diário	c/Software

es.

Material	Aleación
Tecnología	Mifare® (Classic ISO / iEC 14443-4) WIFI - LAN
Método de apertura	Proximidad, Tarjeta, Código
Poder	DC 12V
Leds	Azul
El consumo	< 35mA
Consumo Estático	6µA
Tiempo abierto	Ajustable
Software	iTEC Hybrid
Estar solo	No (solo Wiegand)
IP	IP 65
Distancia de lectura	≤ 55 mm / Toqué
Reconocimiento	0.5s
Peso	0,65 kg
Resistencia a la humedad	< 95%
Temp. de trabajo	-20°C ~ + 65°C
Temp. Almacenamiento	-40°C ~ + 80°C
La recolección de datos	con software
Calendario	con software
Grabación de grabación	con software
Copia de seguridad diaria	con software

en.

Material	Alloy
Technology	Mifare® (Classic ISO/iEC 14443-4) WIFI - LAN
Opening Method	Proximity, Card, Code
Power	DC 12V
Leds	Blue
Driving Consumption	< 35mA
Static Consumption	6µA
Open Time	Adjustable
Software	iTEC Hybrid
Stand Alone	No (Wiegand only)
IP	IP 65
Reading Distance	≤ 55mm / Touch
Recognition	0.5s
Weight	0,65 Kg
Resistance of Humidity	< 95%
Work Temperature	-20°C ~ +65°C
Storage Temperature	-40°C ~ +80°C
Data Collection	w/Software
Calendar	w/Software
Recording Registres	w/Software
Daily Backup	w/Software

fr.

Matériel	Alliage
La technologie	Mifare® (Classic ISO / iEC 14443-4) WIFI - LAN
Méthode d'ouverture	Proximité, Carte, Code
Pouvoir	DC 12V
Leds	Bleu
La consommation	< 35mA
Consommation statique	6µA
Temps ouvert	Réglable
Logiciel	iTEC Hybrid
Rester seul	Non (Wiegand seulement)
IP	IP 65
Distance de lecture	≤ 55mm / Toucher
Reconnaissance	0.5s
Le poids	0,65 kg
Résistance à l'humidité	< 95%
Temp. De travail	-20°C ~ + 65°C
Temp. Stockage	-40°C ~ + 80°C
Collecte de données	a/logiciel
Calendrier	a/logiciel
Enregistrement	a/logiciel
Sauvegarde quotidienne	a/logiciel



ZZA

ABS



CE

IP64



WG



pt. O WF é um leitor de reconhecimento facial e leitor de impressão digital, projetado com microprocessador ARM core de 32 bits. Com a interface Wiegand ou com o iTEC Hybrid pode ser um controlador de acesso independente.

en. WF is a facial recognition reader and fingerprint reader, designed with ARM core 32-bit microprocessor. With Wiegand Interface, can be Standalone Access Controller or with iTEC Hybrid.

es. WF es un lector de reconocimiento facial y lector de huellas digitales, diseñado con un microprocesador ARM core de 32 bits. Con la interfaz Wiegand, puede ser un controlador de acceso independiente o con iTEC Hybrid.

fr. WF est un lecteur de reconnaissance faciale et un lecteur d'empreintes digitales, conçu avec un microprocesseur ARM core 32 bits. Avec l'interface Wiegand, peut être un contrôleur d'accès autonome ou avec un iTEC Hybrid.

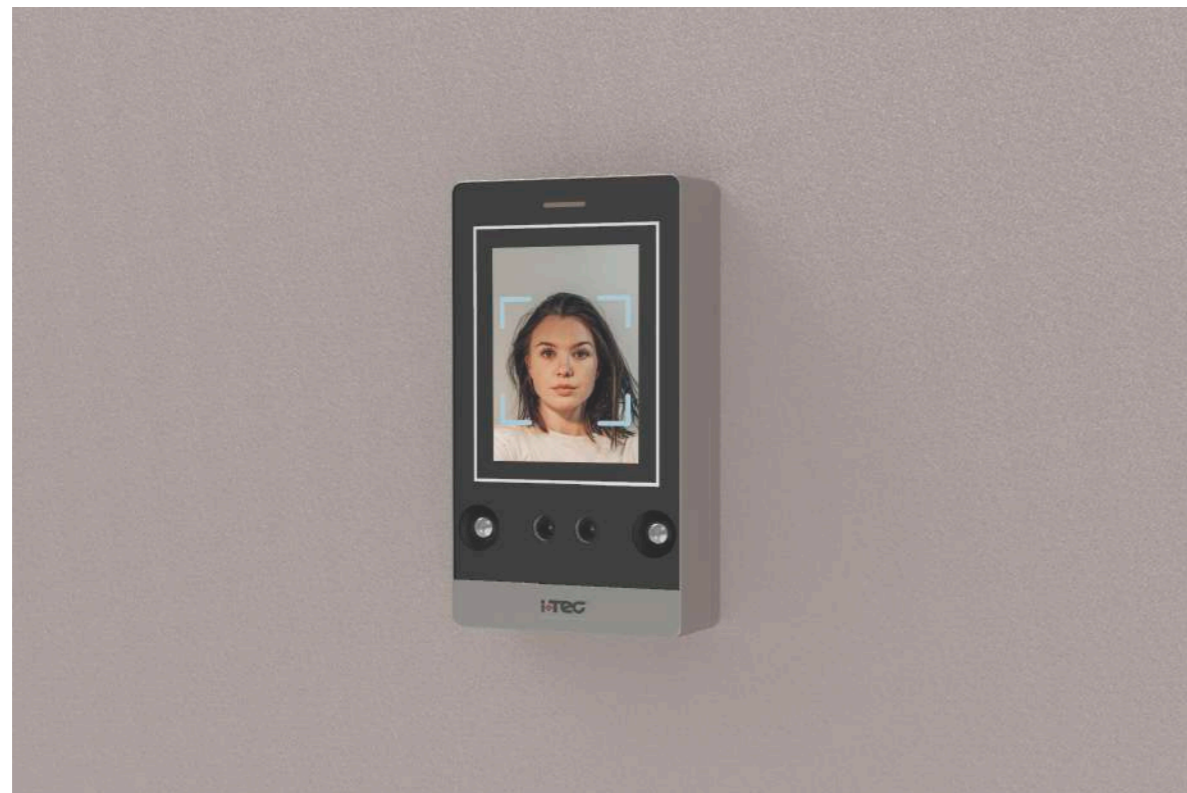

ZZA

ABS



CE

IP64



WG



pt. O WFP é uma nova geração de leitor de reconhecimento facial multifuncional, que usa um microprocessador ARM de 32 bits, estável e confiável. Pode ser usado como um leitor Weigand ou como um Controlador de acesso independente. E é adequado para aplicações de controlo de acesso em escritórios, comunidades residenciais, casas de campo, bancos e outros.

en. The WFP is a new generation of multi-function facial recognition reader, which uses a stable and reliable ARM core 32-bit microprocessor. It can be used as a Weigand reader, or as a Standalone Access Controller. And is suitable for access control applications in offices, residential communities, villa, banks and others.

es. El WFP es una nueva generación de lector de reconocimiento facial multifunción, que utiliza un microprocesador ARM core de 32 bits estable y confiable. Se puede usar como un lector Weigand o como un controlador de acceso independiente. Y es adecuado para aplicaciones de control de acceso en oficinas, comunidades residenciales, villas, bancos y otros.

fr. Le WFP est une nouvelle génération de lecteur de reconnaissance faciale multifonction, qui utilise un microprocesseur 32 bits ARM core stable et fiable. Il peut être utilisé comme lecteur Weigand ou comme contrôleur d'accès autonome. Et convient aux applications de contrôle d'accès dans les bureaux, les communautés résidentielles, les villas, les banques et autres.

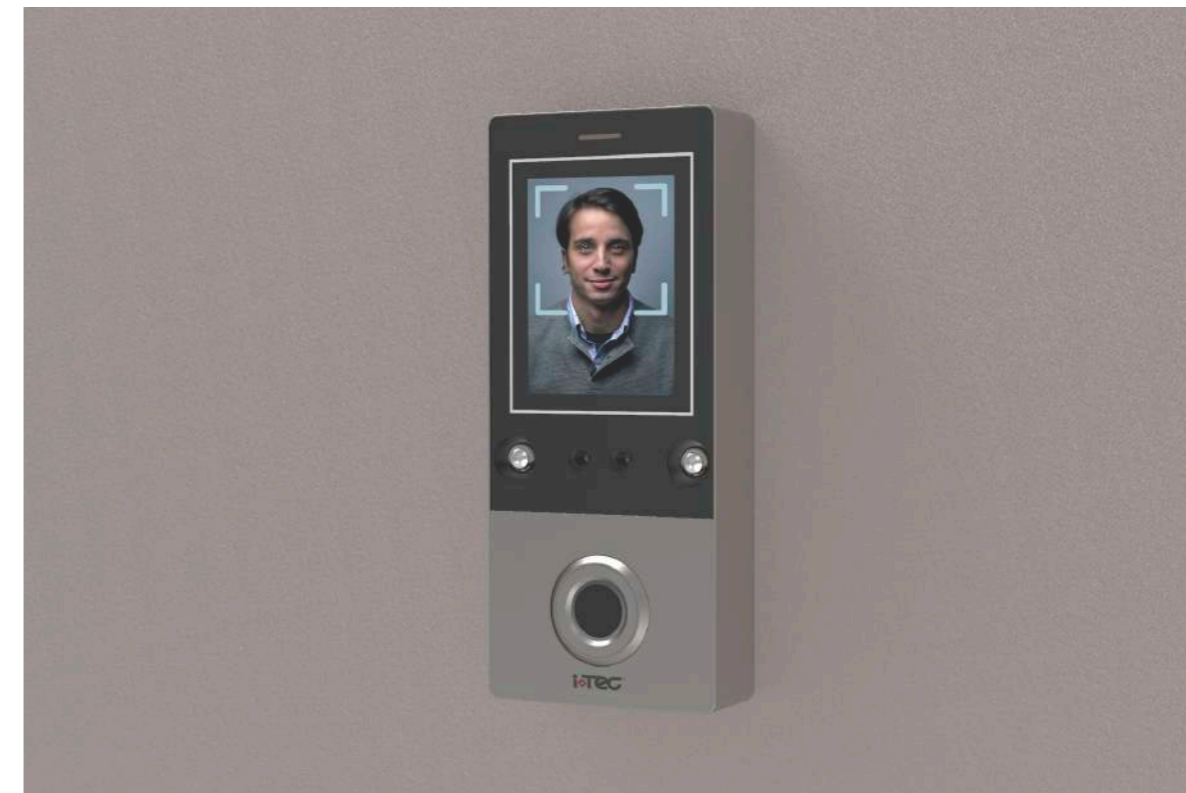

WF®

Ficha Técnica

Datasheet

Hoja Técnica

Fiche Technique

Standalone

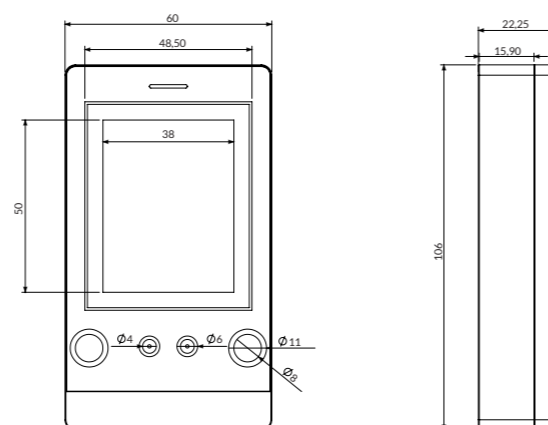

pt.

Material	Níquel Satinado & Vidro
Método de Abertura	Reconhecimento facial
Capacidade	1,000
Protocolo Output	Controle Remoto Infravermelho
Interface	Wiegand
Software	iTEC Hybrid
Standalone	Sim
Distância Reconhecimento	50cm - 100cm
Tempo de Proteção de curto circuito	≤100µs
Humedade de Trabalho	10%~90%
Fecho Output	≤1A
Potência	DC12V
Eletricidade Estática	≤350mA
Alarme Output	≤20A
Corrente Funcionar	≤100mA
Temp. de Trabalho	-40°C~+60°C
Tempo de Abertura	0s~200s

es.

Material	Níquel satinado y Vidrio
Método de Apertura	Reconocimiento facial
Capacidad	1,000
Protocolo de Salida	Control remoto Infrarrojo
Interface	Wiegand
Software	iTEC Hybrid
Standalone	Si
Reconocimiento de Distancia	50cm - 100cm
Tiempo de Protección Contra Cortocircuito	≤100µs
Humedad de Trabajo	10%~90%
Cierre de Salida	≤1A
Potencia	DC12V
Electricidad Estática	≤350mA
Salida de Alarma	≤20A
Carrera Actual	≤100mA
Temperatura. de Trabajo	-40°C~+60°C
Hora de Apertura	0s~200s

en.

Material	Satin Nickel & Glass
Opening Method	Facial recognition
Capacity	1,000
Protocol Output	Remote Control Infrared
Interface	Wiegand
Software	iTEC Hybrid
Standalone	Yes
Distance Recognition	50cm - 100cm
Short Circuit Protection Time	≤100µs
Working Humidity	10%~90%
Lock Output	≤1A
Power	DC12V
Static electricity	≤350mA
Alarm Output	≤20A
Current Run	≤100mA
Work Temperature	-40°C~+60°C
Opening Time	0s~200s

fr.

Matériel	Nickel satiné et verre
Méthode d'ouverture	La reconnaissance faciale
Capacité	1 000
Sortie de protocole	Télécommande infrarouge
Interface	Wiegand
Logiciel	iTEC Hybrid
Standalone	Oui
Reconnaissance de distance	50cm - 100cm
Temps de protection contre les courts-circuits	≤100µs
Humidité de travail	10%~90%
Verrouiller la sortie	≤1A
Puissance	DC12V
Électricité statique	≤350mA
Sortie d'alarme	≤20A
Exécution actuelle	≤100mA
Température de travail	-40°C~+60°C
Horaire d'ouverture	0s~200s

WFP®

Ficha Técnica

Datasheet

Hoja Técnica

Fiche Technique

Standalone

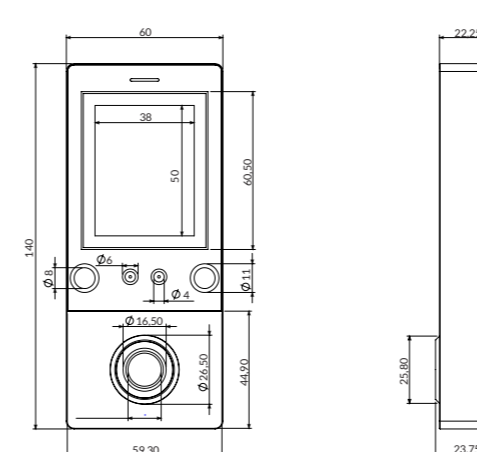

pt.

Material	Níquel Satinado & Vidro
Método de Abertura	Reconhecimento facial, Impressão Digital
Capacidade Facial	1,000
Capacidade Impressão	600
Protocolo Output	Controle Remoto; Infravermelho
Interface	Wiegand
Software	iTEC Hybrid
Standalone	Sim
Dist. Reconhecimento	50cm - 100cm
Tempo de proteção de curto circuito	≤100µs
Humedade de Trabalho	10%~90%
Fecho Output	≤1A
Potência	DC12V
Eletricidade Estática	≤350mA
Alarme Output	≤20A
Corrente Funcionar	≤100mA
Temp. de Trabalho	-40°C~+60°C
Tempo de Abertura	0s~200s

es.

Material	Níquel satinado y Vidrio
Método de Apertura	Reconocimiento facial, Impresión Digital
Capacidad Facial	1,000
Capacidad Impresión	600
Protocolo de Salida	Control remoto; Infrarrojo
Interface	Wiegand
Software	iTEC Hybrid
Standalone	Si
Reconocimiento de Distancia	50cm - 100cm
Tiempo de Protección Contra Cortocircuito	≤100µs
Humedad de Trabajo	10%~90%
Cierre de Salida	≤1A
Potencia	DC12V
Electricidad Estática	≤350mA
Salida de Alarma	≤20A
Carrera Actual	≤100mA
Temperatura. de Trabajo	-40°C~+60°C
Hora de Apertura	0s~200s

en.

Material	Satin Nickel & Glass
Opening Method	Facial recognition, Fingerprint
Capacity Facial	1,000
Capacity Fingerprint	600
Protocol Output	Remote Control Infrared
Interface	Wiegand
Software	iTEC Hybrid
Standalone	Yes
Distance Recognition	50cm - 100cm
Short circuit protection time	≤100µs
Working Humidity	10%~90%
Lock Output	≤1A
Power	DC12V
Static electricity	≤350mA
Alarm Output	≤20A
Current Run	≤100mA
Work Temperature	-40°C~+60°C
Opening Time	0s~200s

fr.

Matériel	Nickel satiné et verre
Méthode d'ouverture	Reconnaissance faciale, Empreinte digitale
Capacité Faciale	1 000
Capacité Empreinte	600
Sortie de protocole	Télécommande infrarouge
Interface	Wiegand
Logiciel	iTEC Hybrid
Standalone	Oui
Reconnaissance de distance	50cm - 100cm
Temps de protection contre les courts-circuits	≤100µs
Humidité de travail	10%~90%
Verrouiller la sortie	≤1A
Puissance	DC12V
Électricité statique	≤350mA
Sortie d'alarme	≤20A
Exécution actuelle	≤100mA
Température de travail	-40°C~+60°C
Horaire d'ouverture	0s~200s

iA660®

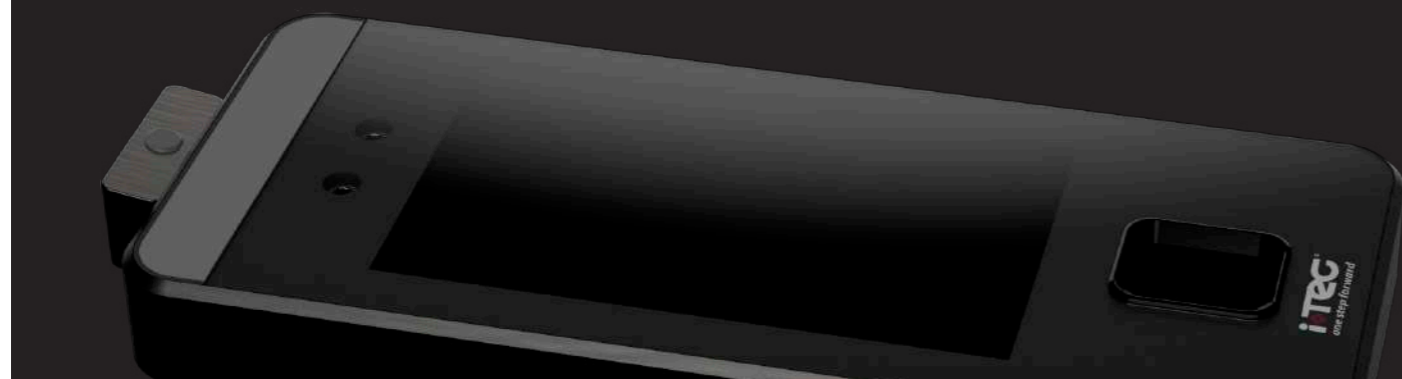

ZZA

ABS



WG



pt. O iA660 é uma solução de controlo de acesso sem toque, que permite o acesso através de reconhecimento facial ou pela palma da mão, elimina assim a necessidade de tocar no terminal de acesso. Além disso, valida o acesso, dependendo da temperatura corporal e do uso de uma máscara.

en. iA660 Reader is a Touchless Access Control Solution, it allows access through facial recognition or the palm of your hand, thus eliminating the need to touch the access terminal. In addition, it validates access depending on body temperature and the use of a mask.

es. El iA660 Reader es una solución de control de acceso sin toque, que permite el acceso a través de reconocimiento facial o por la palma de la mano, elimina así la necesidad de tocar en la terminal de acceso. Además, valida el acceso, dependiendo de la temperatura corporal y del uso de una máscara.

fr. iA660 Reader est une solution de contrôle d'accès sans touche, qui permet l'accès par reconnaissance faciale ou par la paume de la main, élimine ainsi la nécessité de toucher le terminal d'accès. En outre, il valide l'accès en fonction de la température corporelle et de l'utilisation d'un masque.

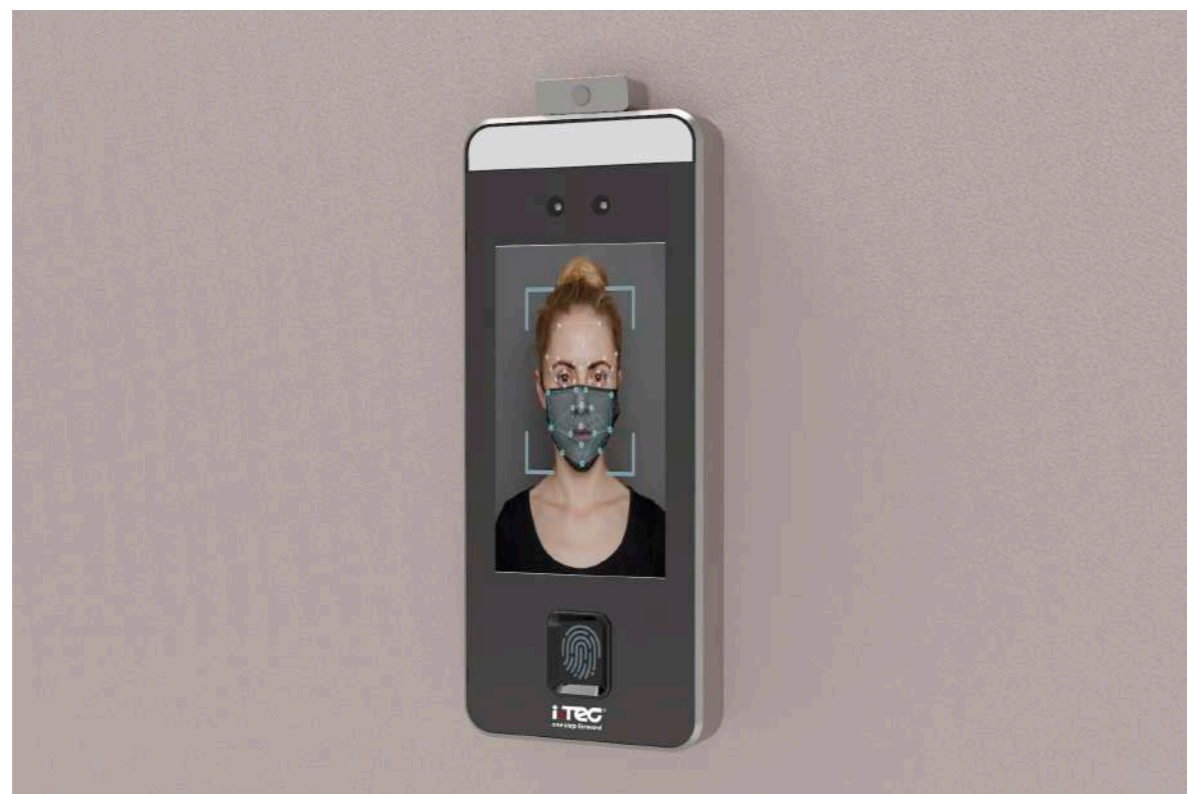

Ficha Técnica | Datasheet | Hoja Técnica | Fiche Technique

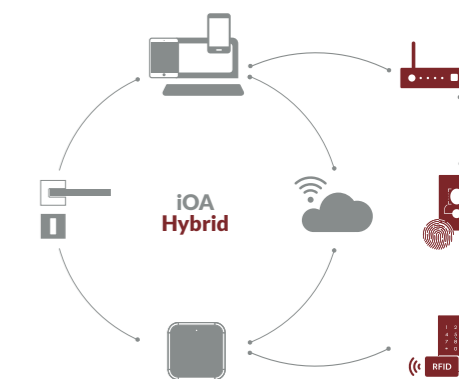
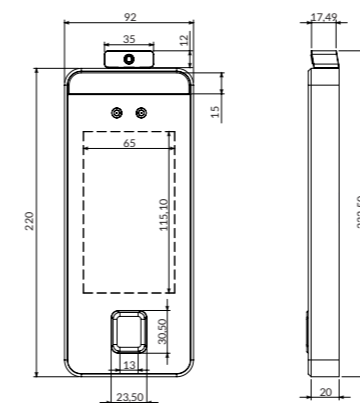
**pt.**

Material
Tecnologia
Método de Abertura

Capacidade Usuários
Capacidade Faciais
Capacidade Palmas
Capacidade Movimentos
Comunicação
Método de verificação
Voz; Multi Idiomas
LCD

Teclado
Câmara
Power
Interfaces
Software
Stand Alone
IP
Reconhecimento
Temp. de Trabalho

Niquel Satinado & Vidro
RFID 125KHz ISO (Opcional)
Reconhecimento facial, Leitor de palma, Senha
10,000 (1:1 Modo Online - Ilimitado)
6,000 (1:1 Modo Online - Ilimitado)
3,000
200,000
WiFi, TCP/IP, USB Host, RS485
Temperatura, deteção de máscara
Sim
5" Cores
Touch
Infravermelho de alta resolução
Contacto NA/NF, Alarme, Botão,
Wiegand, RS485
iTEC Hybrid
Não
IP 56
< 1s
0°C~+45°C

es.

Material
Tecnología
Método de Apertura

Capacidad Usuarios
Capacidad Facial
Capacidad Palmas
Capacidad Movimientos
Comunicación
Método de verificación
Voz; Múltiples lenguas
LCD
Teclado
Cámara
Poder
Interfaces

Software
Stand Alone
IP
Reconocimiento
Temp. de trabajo

Niquel Satinado & Vidrio
RFID 125KHz ISO (Opcional)
Reconocimiento facial, lector de Palm, contraseña
10,000 (1:1 Modo en línea: ilimitado)
6,000 (1:1 Modo en línea: ilimitado)
3,000
200,000
WiFi, TCP/IP, USB Host, RS485
Temperatura, detección de máscara
Si
5" Colores
Toque
Infrarrojos de alta resolución
12V DC / 3A
Contacto NA / NC, alarma, botón,
Wiegand, RS485
iTEC Hybrid
No
IP 56
< 1s
0°C~+45°C

en.

Material
Technology
Opening Method

Capacity Users
Capacity Facials
Capacity Palms
Capacity Movements
Communication
Verification Method
Voice; Multi-language
LCD

Keyboard
Camera
Power
Interfaces
Software
Stand Alone
IP
Recognition
Work Temperature

Satin Nickel & Glass
RFID 125KHz ISO (Optional)
Facial Recognition, Palm reader, Passcode
10,000 (1:1 OnlineUnlimited)
6,000 (1:1 OnlineUnlimited)
3,000
200,000
WiFi, TCP/IP, USB Host, RS485
Temperature, Mask detection
Yes
5" Colors
Touch
High Resolution Infrared
Contact NA/NF, Alarm, Button,
Wiegand, RS485
iTEC Hybrid
No
IP 56
< 1s
0°C~+45°C

fr.

Matériel
La technologie
Méthode d'ouverture

Utilisateurs de capacité
Soins du visage de capacité
Palmiers de capacité
Mouvements de capacité
La communication
Méthode de vérification
Voix; Multi-langue
LCD
Clavier
Caméra
Pouvoir
Interfaces

Logiciel
Rester seul
IP
Reconnaissance
Temp. De travail

Nickel Satiné & Verre
RFID 125KHz ISO (Optionnel)
Reconnaissance faciale, lecteur Palm, code d'accès
10,000 (1:1 Online Mode - Unlimited)
6,000 (1:1 Online Mode - Unlimited)
3,000
200,000
WiFi, TCP/IP, USB Host, RS485
Temperature, Mask detection
Oui
5" Couleurs
Toucher
Infrarouge haute résolution
12V DC / 3A
Contact NA/NF, Alarme, Bouton, Wiegand, RS485
iTEC Hybrid
Non
IP 56
< 1s
0°C~+45°C

iAccess Lift®



ABS

Mifare

CE

IP44

pt. O iAccess Lift é um sistema de controlo complementar, usado na permissão ou restrição de acesso a uma área específica e/ou controlo de qualquer sistema eléctrico (como elevadores). O acesso é pré-definido para cada utilizador.

en. The iAccess Lift is a complementary control system used in the permission or restriction of access to a specific area and/or control any electrical system (such as elevators). The access is predefined to each user.

es. El iAccess Lift es un sistema de control complementario, usado en la permisión de restricción de acceso a una área específica y/o control de cualquier sistema eléctrico (como ascensores). El acceso es pré-definido para cada utilizador.

fr. iAccess Lift est un système de contrôle complémentaire utilisé pour autoriser ou restreindre l'accès à une zone spécifique et/ou pour contrôler tout système électrique (tel que les ascenseurs). L'accès est prédéfini pour chaque utilisateur.

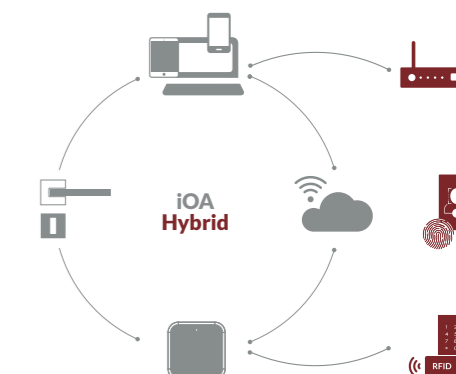
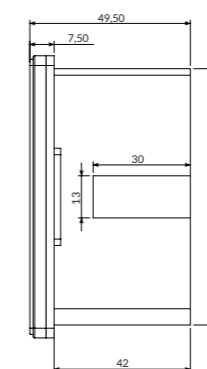
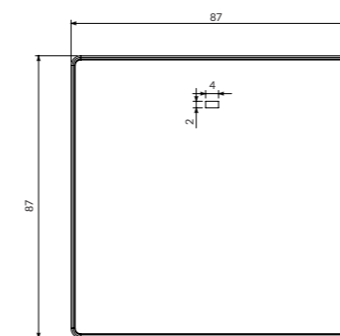

Ficha Técnica | Datasheet | Hoja Técnica | Fiche Technique

**pt.**

Material	ABS
Tecnologia	Mifare® (Classic ISO / iEC 14443-4)
Método de Abertura	Proximidade
Potência	12V DC
Leds	Sim
Consumo	350mA
Consumo Estático	15µA
Tempo Aberto	Regulável
Software	SFT01/iTEC Hybrid
Stand Alone	Não
Reconhecimento	0.5s
Peso	0,7 Kg
Resistencia à Humidade	< 98%
Temp. de Trabalho	-30°C ~ +65°C
Temp. Armazenamento	-20°C ~ +55°C
Recolha de Dados	Sim
Limite de Abertura	Sim
Níveis de Utilizadores	Sim
Controlador	16 andares*

es.

Material	ABS
Tecnología	Mifare® (Classic ISO / iEC 14443-4)
Método de apertura	Proximidad
Poder	12V DC
Leds	Si
El consumo	350mA
Consumo Estático	15µA
Tiempo abierto	Ajustable
Software	SFT01 / iTEC Hybrid
Estar solo	No
Reconocimiento	0.5s
Peso	0,7 kg
Resistencia a la humedad	< 98%
Temp. de trabajo	-30°C ~ + 65°C
Temp. Almacenamiento	-20°C ~ + 55°C
La recolección de datos	Si
Accesos futuros	Si
Límite de apertura	Si
Niveles de usuarios	Si
Controlador	16 pisos*

en.

Material	ABS
Technology	Mifare® (Classic ISO / iEC 14443-4)
Opening Method	Proximity
Power	12V DC
Leds	Yes
Driving Consumption	350mA
Static Consumption	15µA
Open Time	Adjustable
Software	SFT01 / iTEC Hybrid
Stand Alone	No
Recognition	0.5s
Weight	0,7Kg
Resistance of Humidity	< 98%
Work Temperature	-30°C ~ +65°C
Storage Temperature	-20°C ~ +55°C
Data Collection	Yes
Limit of Openings	Yes
User Levels	Yes
Controller	16 floors*

fr.

Matériel	ABS
La technologie	Mifare® (Classic ISO / iEC 14443-4)
Méthode d'ouverture	Proximité
Pouvoir	12V DC
Leds	Oui
La consommation	350mA
Consommation statique	15µA
Temps ouvert	Ajustable
Logiciel	SFT01 / iTEC Hybrid
Rester seul	Non
Reconnaissance	0.5s
Le poids	0,7 kg
Résistance à l'humidité	< 98%
Temp. De travail	-30°C ~ + 65°C
Temp. Stockage	-20°C ~ + 55°C
Collecte de données	Oui
Limite d'ouverture	Oui
Niveaux d'utilisateur	Oui
Contrôleur	16 planchers*



ZZA

CE

IP44

pt. O iBT 01 é um botão de saída de desbloqueio da porta de controlo de acesso, adequado para todos os tipos de sistema de controlo de acesso de porta, abra a sua porta com apenas um toque no botão.

en. iBT 01 is a access control door release exit button, suitable for all kind o door access control system, open your door with the touch of one button.

es. El iBT 01 es un botón de salida de desbloqueo de puertas de control de acceso, adecuado para todo tipo de sistema de control de acceso de puertas, abra su puerta con solo tocar el botón.

fr. iBT 01 est un bouton de sortie de déverrouillage de porte de contrôle d'accès, adapté à tout type de système de contrôle d'accès de porte, ouvrez votre porte d'une simple pression sur un bouton.



Ficha Técnica | Datasheet | Hoja Técnica | Fiche Technique

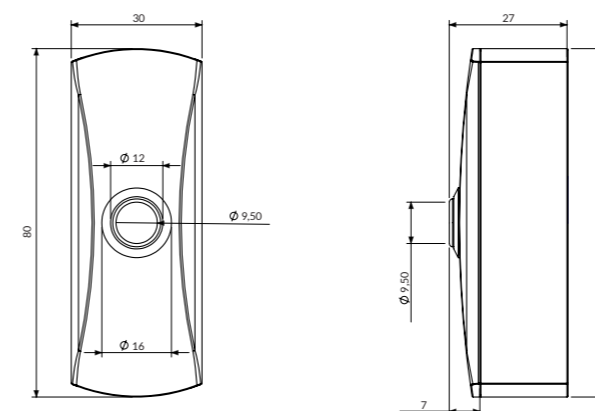

pt.

Material	ABS; Liga Metálica
Método de Abertura	Botão
Tipo de porta	Porta oca
Indicador LED branco	Desligar
Indicador LED azul	Ligado (espera)
Indicador LED vermelho	Ligar (sensação)
Tensão de entrada	DC12V (24V opcional)
Desempenho elétrico	3A@36VDC
Contato de saída	NO\NC\COM
Vida mecânica	500000 testado
Consumo	350mA
Consumo Estático	15µA
Tempo Aberto	7s
IP	IP56
Peso	0,15 - 0,2 Kg
Humidade de trabalho	0-95%
Temp. de Trabalho	-10°C -55°C
Temp. Armazenamento	-20°C~+55°C
Recolha de Dados	Sim
Limite de Abertura	Sim

es.

Material	ABS; Aleación
Método de apertura	Botón
Adecuado para puerta	Puerta hueca
Indicador LED blanco	Apagado
Indicador LED azul	Encendido (en espera)
Indicador LED rojo	Encendido (sensación)
Voltaje de entrada	DC12V (opcional 24V)
Rendimiento eléctrico	3 A a 36 V CC
Contacto de salida	NO \ NC \ COM
Vida mecánica	500000 probado
Consumo de conducción	350 mA
Consumo estático	15µA
Tiempo abierto	7 s
IP	IP 56
Peso	0,15 - 0,2Kg
Humedad de trabajo	0-95%
Temperatura de trabajo	-10°C -55°C
Temperatura	-20°C ~ + 55°C
Recopilación de datos	Si
Límite de aperturas	Si

en.

Material	ABS; Alloy
Opening Method	Button
Suitable for door	Hollow door
White LED indicator	Power OFF
Blue LED indicator	Power ON (standby)
Red LED indicator	Power on (sensation)
Input voltage	DC12V (optional 24V)
Electrical performance	3A@36VDC
Output contact	NO\NC\COM
Mechanical life	500000 tested
Driving Consumption	350mA
Static Consumption	15µA
Open Time	7s
IP	IP 56
Weight	0,15 - 0,2Kg
Working Humidity	0-95%
Work Temperature	-10°C -55°C
Storage Temperature	-20°C~+55°C
Blacklist Card	Yes
Limit of Openings	Yes

fr.

Matériel	ABS; Alliage
Méthode d'ouverture	Bouton
Convient pour la porte	Porte creuse
Indicateur LED blanc	Éteindre
Indicateur LED bleu	Mise sous tension (veille)
Indicateur LED rouge	Allumer (sensation)
Tension d'entrée	DC12V (24 V en option)
Performance électrique	3A à 36VDC
Contact de sortie	NON \ NC \ COM
Vie mécanique	500000 testés
Consommation	350 mA
Consommation statique	15µA
Temps ouvert	7 s
IP	IP 56
Poids	0,15 à 0,2Kg
Humidité de travail	0 à 95%
Température de travail	-10°C -55°C
Température de stockage	-20 ° C à + 55 ° C
Collecte de données	Oui
Limite des ouvertures	Oui

iBT 02®



ZZA

ABS



CE

IP44



pt. iBT 02 incorpora um mecanismo inovador de desbloqueio de porta. Para sair ative o desbloqueio ao passar um dedo no sensor de saída. Com várias opções de configuração de contacto, torne o iBT 02 compatível com qualquer controlador de porta.

en. iBT 02 incorporates an innovative door unlocking mechanism. To exit activates the unlock by swiping a finger on the exit sensor. With several contact configuration options, it makes the iBT 02 compatible with any door controller.

es. iBT 02 incorpora un innovador mecanismo de desbloqueo de puertas. Para salir, se activa el desbloqueo deslizando un dedo sobre el sensor de salida. Con varias opciones de configuración de contactos, hace que el iBT 02 sea compatible con cualquier controlador de puerta.

fr. iBT 02 intègre un mécanisme de déverrouillage de porte innovant. Sortir active le déverrouillage en faisant glisser un doigt sur le capteur de sortie. Avec plusieurs options de configuration de contact, il rend l'iBT 02 compatible avec n'importe quel contrôleur de porte.

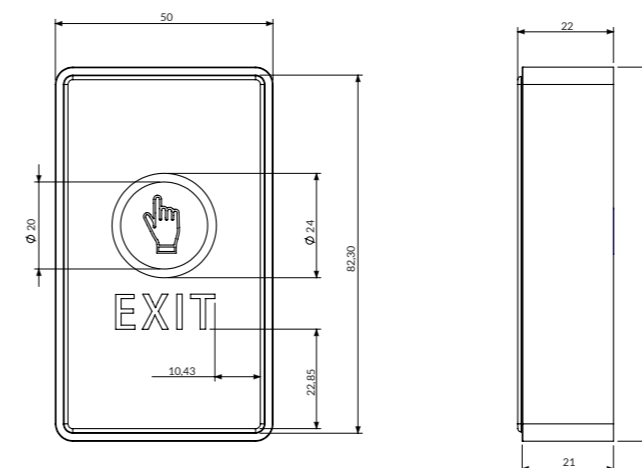

Ficha Técnica | Datasheet | Hoja Técnica | Fiche Technique

**pt.**

Material	ABS
Método de Abertura	Proximidade iBTR
Tensão de entrada	DC 12V (24V opcional)
Desempenho elétrico	3A@12VDC
Consumo	350mA
Consumo Estático	15µA
Tempo Aberto	7s
Indicador LED azul	Ligado
Vida mecânica	500000 testado
IP	44
Distância de Leitura	≤ 50mm
Reconhecimento	0.5s
Peso	0,7 Kg
Resistencia à Humidade	<98%
Temp. de Trabalho	-30°C~+65°C
Temp. Armazenamento	-20°C~+55°C

en.

Material	ABS
Opening Method	Proximity
Input voltage	DC 12V (Optional 24V)
Electric performance	3A@12VDC
Driving Consumption	350mA
Static Consumption	15µA
Open Time	7s
Blue LED indicator	Power ON
Mechanical life	500000 tested
IP	44
Reading Distance	≤ 50mm
Recognition	0.5s
Weight	0,7Kg
Resistance of Humidity	<98%
Work Temperature	-30°C~+65°C
Storage Temperature	-20°C~+55°C

es.

Material	ABS
Método de apertura	Proximidad
Voltaje de entrada	DC 12V (opcional 24V)
Rendimiento eléctrico	3A @ 12VDC
Consumo de conducción	350 mA
Consumo estático	15µA
Tiempo abierto	7 s
Indicador LED azul	Encendido
Vida mecánica	500000 probado
IP	44
Distancia de lectura	≤ 50 mm
Reconocimiento	0,5 s
Peso	0,7Kg
Resistencia a la humedad	<98%
Temperatura de trabajo	-30°C ~ + 65°C
Temperatura de almacenamiento	-20°C ~ + 55°C

fr.

Matériel	ABS
Méthode d'ouverture	Proximity
Tension d'entrée	DC 12V (Optional 24V)
Performance électrique	3A@12VDC
Consommation de conduite	350mA
Consommation statique	15µA
Temps ouvert	7s
Indicateur LED bleu	Power ON
Vie mécanique	500000 tested
IP	44
Distance de lecture	≤ 50mm
Reconnaissance	0.5s
Poids	0,7Kg
Résistance à l'humidité	<98%
Température de travail	-30°C~+65°C
Température de stockage	-20°C~+55°C

iBP 01® | iBP 01R®



iBP 01 v2.0® | iBP 01R v2.0®



SSS

ABS



CE

IP44



pt. iBP 01 é um botão de proximidade, com tecnologia infravermelha. Perfeita para ambientes estéreis, como hospitais, salas limpas, restaurantes ou laboratórios, é a opção mais eficaz para ativar a saída (REX) em vários sistemas de controlo de acesso. Pode ser aberto pelo exterior com controlo remoto (iBP 01R) ou integrado com terminal de acesso.

en. iBP 01 is a proximity button, with advanced infrared technology. Perfect choice for sterile environments, such as hospitals, clean rooms, restaurants, bathrooms or laboratories, it is the most effective option for requesting exit (REX) in various access control systems. It can be opened from the outside with a remote control (iBP 01R) or integrated with an access terminal.

es. iBP 01 es un botón de proximidad, con tecnología infrarroja. Perfecto para entornos estériles, como hospitales, salas blancas, restaurantes o laboratorios, es la opción más efectiva para activar la salida (REX) en varios sistemas de control de acceso. Puede abrirse desde el exterior con control remoto (iBP 01R) o integrarse con un terminal de acceso.

fr. iBP 01 est un bouton de proximité, avec une technologie infrarouge. Choix parfait pour les environnements stériles, tels que les hôpitaux, les salles blanches, les salles de bain ou les laboratoires, c'est l'option la plus efficace pour demander la sortie (REX) dans divers systèmes de contrôle d'accès. Il peut être ouvert de l'extérieur avec une télécommande (iBP 01R) ou intégré à un terminal d'accès.

iBP 01®



iBP 01R®



SSS

ABS



CE

IP44



pt. iBP 01 v2.0 é um botão de saída sem toque e preventivo para a disseminação de bactérias e vírus. Pode ser aberto pelo exterior com controlo remoto (iBP 01R v2.0) ou integrado com terminal de acesso.

en. iBP 01 v2.0 is a touch-free exit button makes preventive use for the spread of bacteria and viruses. It can be opened from the outside with a remote control (iBP 01R v2.0) or integrated with an access terminal.

es. iBP 01 v2.0 es un botón de salida sin contacto es preventivo para la propagación de bacterias y virus. Puede abrirse desde el exterior con control remoto (iBP 01R v2.0) o integrarse con un terminal de acceso.

fr. iBP 01R v2.0 est un bouton de sortie sans contact permet une utilisation préventive de la propagation des bactéries et des virus. Il peut être ouvert de l'extérieur avec une télécommande (iBP 01R v2.0) ou intégré à un terminal d'accès.

iBP 01 v2.0®



iBP 01R v2.0®



SSS

ABS



CE

IP44



SSS

ABS



CE

IP44



iBP 01[®] | iBP 01R[®]**Ficha Técnica**

Datasheet

Hoja Técnica

Fiche Technique

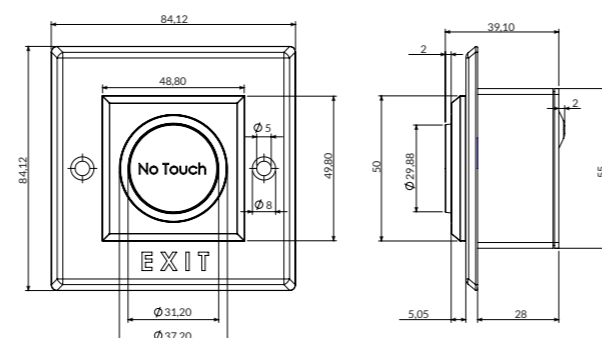
**pt.**

Material	Inox Satinado
Tecnologia	Infravermelho
Método de Abertura	Proximidade, Controlo Remoto (iBP01R), Terminal Acesso
LED Azul	Ligado (Standby)
Power	3A, 36VDC Max
Contacto de Saída	NC\COM
Utilizações	1.000.000
Temp. de Trabalho	-10°C~+55°C
Resistencia à Humidade	0 - 95%
Distância de Reconhecimento	0.1 - 10cm

en.

Material	Stainless Steel
Technology	Infra-red
Opening Method	Proximity, Remote Control (iBP01R), Access Terminal
Blue LED	Power On (Standby)
Power	3A, 36VDC Max
Output Contact	NC \ COM
Uses	1,000,000
Temp. Working	-10°C ~ + 55°C
Humidity Resistance	0 - 95%
Recognition Distance	0.1 - 10cm

es.

Material	Acero Inox
Tecnología	Infrarrojo
Método de Abertura	Proximidad, Control Remoto (iBP01R), Terminal de Acceso
LED azul	En (modo de espera)
Poder	3A, 36VDC Máx.
Contacto de salida	NC \ COM
Usos	1,000,000
Temperatura. de trabajo	-10°C ~ + 55°C
Resistencia a la humedad	0 - 95%
Distancia de reconocimiento	0.1 - 10cm

fr.

Material	Stainless Steel
Technology	Infrarouge
Opening Method	Proximité, télécommande (iBP01R), borne d'accès
LED bleue	Mise sous tension (veille)
Puissance	3A, 36VDC Max
Contact de sortie	NC \ COM
Les usages	1,000,000
Temp. Travail	-10°C ~ + 55°C
Résistance à l'humidité	0 - 95%
Distance de reconnaissance	0.1 - 10cm

iBP 01 v2.0[®] | iBP 01R v2.0[®]**Ficha Técnica**

Datasheet

Hoja Técnica

Fiche Technique

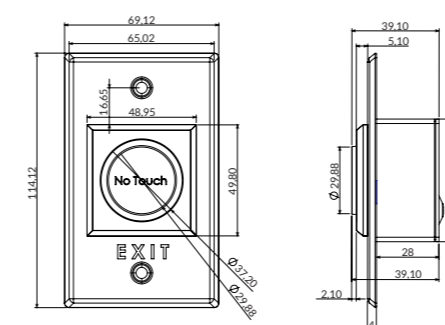
**pt.**

Material	Inox Satinado
Tecnologia	Infravermelho
Método de Abertura	Proximidade, Controlo Remoto (iBP01R), Terminal Acesso
LED Branco	Desligado
LED Azul	Ligado (Standby)
LED Vermelho	Ligado
Power	3A, 36VDC Max
Contacto de Saída	NC\COM
Utilizações	1.000.000
Temp. de Trabalho	-10°C~+55°C
Resistencia à Humidade	0 - 95%
Distância Reconhecimento	0.1 - 10cm

en.

Material	Stainless Steel Satin
Technology	Infra-red
Opening Method	Proximity, Remote Control (iBP01R), Terminal Access
White LED	Off
Blue LED	On (Standby)
Red LED	Switched on
Power	3A, 36VDC Max
Outgoing Contact	NC\COM
Uses	1,000,000
Temp. of work	-10°C~+55°C
Moisture Resistance	0-95%
Recognition Distance	0.1- 10cm

es.

Material	Acero Inoxidable Satinado
Tecnología	Infrarrojo
Método de apertura	Proximidad, control remoto (iBP01R), acceso a terminal
LED blanco	Apagado
LED azul	En modo de espera)
LED rojo	Encender
Energía	3A, 36 V CC máx.
Contacto saliente	NC\COM
Usos	1,000,000
Temperatura. de trabajo	-10°C~+55°C
Resistencia a la humedad	0-95%
Distancia de reconocimiento	0,1-10 cm

fr.

Matériel	Acier inoxydable satiné
La technologie	Infrarouge
Méthode d'ouverture	Proximité, télécommande (iBP01R), accès borne
DEL blanche	Désactivé
DEL bleue	en mode veille)
DEL rouge	Allumer
Énergie	3A, 36V CC max.
Contact sortant	CN\COM
Applications	1 000 000
Température. de travail	-10°C~+55°C
Résistance à l'humidité	0-95%
Distance de reconnaissance	0.1-10cm

CB 04® | CB 06®



pt. O CB 04 é um armário aberto através de tecnologia “botão inteligente” ou código PIN. Com um sistema aleatório, apresentamos o CB 06. Após a utilização do cacofo a fechadura permanece aberta até que um novo utilizador a tranque e depois a abra, utilizando apenas um novo código ou o respetivo botão inteligente.

en. CB 04 is a Standalone locker, opened using smart button technology or PIN code. With a random system, we present the CB 06 after using the locker the lock remains open until a new user locks it and then opens it, using only a new code or the smart button.

es. CB 04 es un casillero independiente, que se abre con tecnología de botón inteligente o código PIN. Con un sistema aleatorio, presentamos el CB 06 después de usar el casillero, la cerradura permanece abierta hasta que un nuevo usuario lo bloquea y luego lo abre, usando solo un nuevo código o el botón inteligente.

fr. CB 04 est un casier autonome, qui s'ouvre avec la technologie du bouton intelligent ou du code PIN. Avec un système aléatoire, nous introduisons la CB 06 après avoir utilisé le casier, la serrure reste ouverte jusqu'à ce qu'un nouvel utilisateur la verrouille puis l'ouvre, en utilisant uniquement un nouveau code ou le bouton intelligent.

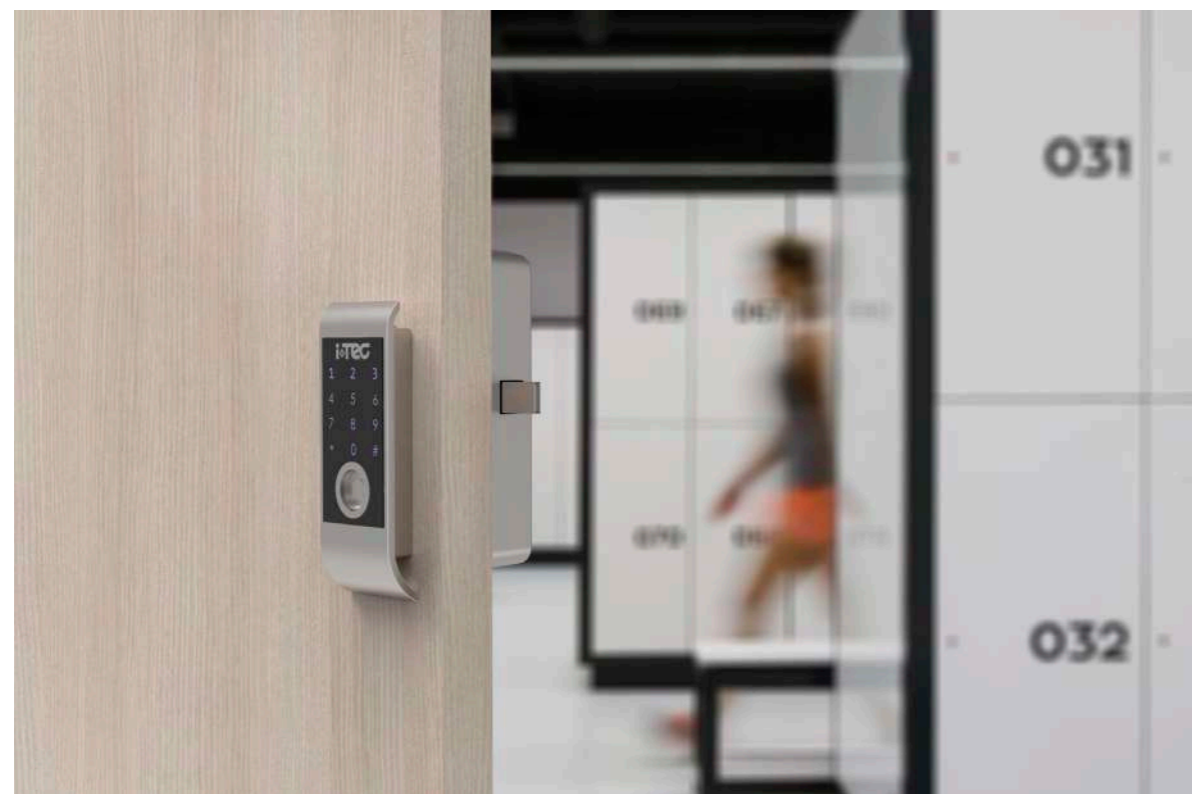

CB 05® | CB 08®



pt. CB 05 é uma fechadura RFID com software de gestão. Contém controlo de registos, pré-definição de acessos, alarme, utilizadores ilimitados. Com um sistema aleatório, apresentamos o CB 08. Após a utilização do armário, a fechadura permanece aberta até que um novo utilizador a bloqueie e depois a abra, utilizando apenas um novo cartão.

en. CB 05 is an RFID lock with software management. Contains registry control, access pre-definition, alarm, unlimited users. With a random system, we present the CB 08 that after using the locker the lock remains open until a new user locks it and then opens it, using only a new card.

es. CB 05 es una cerradura RFID con software de gestión. Contiene control de registro, predefinición de acceso, alarma, usuarios ilimitados. Con un sistema aleatorio, presentamos el CB 08 que después de usar el casillero la cerradura permanece abierta hasta que un nuevo usuario lo bloquea y luego lo abre, usando solo una nueva tarjeta.

fr. CB 05 est une serrure RFID avec logiciel de gestion. Contient le contrôle du registre, le pré-réglage d'accès, l'alarme, les utilisateurs illimités. Avec un système aléatoire, nous présentons le CB 08 qu'après avoir utilisé le casier, la serrure reste ouverte jusqu'à ce qu'un nouvel utilisateur la verrouille puis l'ouvre, en utilisant uniquement une nouvelle carte.



CB 04® | CB 06®

Ficha Técnica

Datasheet

Hoja Técnica

Fiche Technique

Standalone

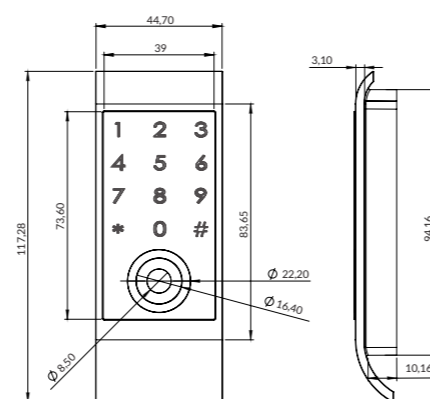

pt.

Material	Liga de Zinco
Método de Abertura	Botão Inteligente/Código PIN
Potência	DC 4,5v (AA*3)
Vida Útil da Bateria	~ 8 meses
Leds	Verde e Vermelho
Alarme de Bateria Fraca	3 Longos BIP
Consumo	260mA
Consumo Estático	7µA
Tempo Aberto	10s
Número de Aberturas	~ 2000 Aberturas (1 Ano)
Software	Não
Stand Alone	Sim
IP	IP56
Distância de Leitura	Toque
Reconhecimento	0.5s
Peso	0,2 Kg
Resistencia à Humidade	< 95%
Temp. de Trabalho	-20°C ~ +70°C
Temp. de Armazenameto	-40°C ~ +80°C
Espessura da Porta	16mm

es.

Material	Aleación de zinc
Método de apertura	Botón inteligente/Código PIN
Poder	DC 4.5v (AA * 3)
Duración de la batería	~ 8 meses
Leds	Verde y rojo
Alarma de batería baja	3 BIP largos
El consumo	260mA
Consumo Estático	7µA
Tiempo abierto	10s
Numero de aperturas	~ 2000 aperturas (1 año)
Software	No
Estar solo	Si
IP	IP56
Distancia de lectura	Toque
Reconocimiento	0.5s
Peso	0,2 kg
Resistencia a la humedad	< 95%
Temp. de trabajo	-20°C ~ + 70°C
Temp. Almacenamiento	-40°C ~ + 80°C
Espesor de la puert	16mm

en.

Material	Zinc Alloy
Opening Method	Smart Button/Pin Code
Power	DC 4,5v (AA*3)
Battery Lifetime	~ 8 months
Leds	Green and Red
Low Battery Alarm	3 Long tick before operation
Driving Consumption	260mA
Static Consumption	7µA
Open Time	7s
Number of openings	~ 2000 Openings (1 Year)
Software	No
Stand Alone	Yes
IP	IP 56
Reading Distance	Touch
Recognition	0.5s
Weight	0,2 Kg
Resistance of Humidity	< 95%
Work Temperature	-20°C ~ +70°C
Storage Temperature	-40°C ~ +80°C
Door Thickness	16mm

fr.

Matériel	Alliage de zinc
Méthode d'ouverture	Bouton intelligent / code PIN
Pouvoir	DC 4.5v (AA * 3)
Vie de la batterie	~ 8 mois
Leds	Vert et rouge
Alarme de batterie faible	3 long BIP
La consommation	260mA
Consommation statique	7µA
Temps ouvert	10s
Nombre d'ouvertures	~ 2000 ouvertures (1 an)
Logiciel	Oui
Rester seul	Oui
IP	IP56
Distance de lecture	Toucher
Reconnaissance	0.5s
Le poids	0,2 kg
Résistance à l'humidité	< 95%
Temp. De travail	-20°C ~ + 70°C
Temp. Stockage	-40°C ~ + 80°C
Porte épaisseur	16mm

CB 05® | CB 08®

Ficha Técnica

Datasheet

Hoja Técnica

Fiche Technique

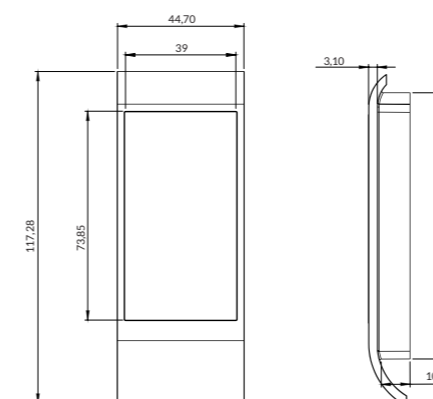

CB08



Standalone

pt.

Material	Liga de Zinco
Tecnologia	Mifare® (Classic ISO/iEC 14443-4)
Método de Abertura	Proximidade
Potência	DC 4,5V (AA*3)
Vida Útil da Bateria	~ 8 meses
Leds	Verde e Vermelho
Alarme de Bateria Fraca	3 Longos BIP
Consumo	260mA
Consumo Estático	7µA
Tempo Aberto	10s
Número de Aberturas	~ 2000 Aberturas (1 Ano)
Software	Não
Stand Alone	Sim
IP-Peso	IP56-0,2 Kg
Distância de Leitura	≤ 55mm
Reconhecimento	0.5s
Resistencia à Humidade	< 95%
Temp. de Trabalho	-20°C ~ +70°C
Temp. de Armazenameto	-40°C ~ +80°C
Espessura da Porta	16mm

es.

Material	Aleación de zinc
Tecnología	Mifare® (Classic ISO / iEC 14443-4)
Método de apertura	Proximidad
Poder	DC 4.5V (AA * 3)
Duración de la batería	~ 8 meses
Leds	Verde y rojo
Alarma de batería baja	3 BIP largos
El consumo	260mA
Consumo Estático	7µA
Tiempo abierto	10s
Numero de aperturas	~ 2000 aperturas (1 año)
Software	No
Estar solo	Si
IP-Peso	IP56-0,2 kg
Distancia de lectura	≤ 55 mm
Reconocimiento	0.5s
Resistencia a la humedad	< 95%
Temp. de trabajo	-20°C ~ + 70°C
Temp. Almacenamiento	-40°C ~ + 80°C
Espesor de la puerta	16mm

en.

Material	Zinc Alloy
Technology	Mifare® (Classic ISO/iEC 14443-4)
Opening Method	Proximity
Power	DC 4,5V (AA*3)
Battery Lifetime	~ 8 months
Leds	Green and Red
Low Battery Alarm	3 Long tick before operation
Driving Consumption	260mA
Static Consumption	7µA
Open Time	7s
Number of openings	~ 2000 Openings (1 Year)
Software	No
Stand Alone	Yes
IP-Weight	IP 56-0,2 Kg
Reading Distance	≤ 55mm
Recognition	0.5s
Resistance of Humidity	< 95%
Work Temperature	-20°C ~ +70°C
Storage Temperature	-40°C ~ +80°C
Door Thickness	16mm

fr.

Matériel	Alliage de zinc
La technologie	Mifare® (Classic ISO / iEC 14443-4)
Méthode d'ouverture	Proximité
Pouvoir	DC 4.5V (AA * 3)
Vie de la batterie	~ 8 mois
Leds	Vert et rouge
Alarme de batterie faible	3 long BIP
La consommation	260mA
Consommation statique	7µA
Temps ouvert	10s
Nombre d'ouvertures	~ 2000 ouvertures (1 an)
Logiciel	No
Rester seul	Oui
IP	IP56-0,2 kg
Distance de lecture	≤ 55mm
Reconnaissance	0.5s
Résistance à l'humidité	< 95%
Temp. De travail	-20°C ~ + 70°C
Temp. Stockage	-40°C ~ + 80°C
Porte épaisseur	16mm

CB 10[®]

ZZA

1x
AA*3

CE

IP44



pt. CB 10 é uma fechadura de cacifo Standalone, aberta através de código PIN. CB 10 tem uma versão de sistema aleatório, depois de usar o cacifo a fechadura permanece aberta até um novo utilizador a trancar e posteriormente abrir, ao introduzir um novo código.

en. CB 10 is a Standalone locker, opened via PIN code. CB 10 has a random system version, after using the locker the lock remains open until a new user locks it and then opens it when entering a new code.

es. CB 10 es un bloqueo de taquilla Standalone, abierto mediante un código PIN. CB 10 tiene una versión aleatoria del sistema, después de usar la taquilla, el bloqueo permanece abierto hasta que un nuevo usuario lo bloquea y luego lo abre al ingresar un nuevo código.

fr. CB 10 est un casier autonome, ouvert via un code PIN. CB 10 a une version de système aléatoire, après avoir utilisé le casier, le verrou reste ouvert jusqu'à ce qu'un nouvel utilisateur le verrouille puis l'ouvre lors de la saisie d'un nouveau code.

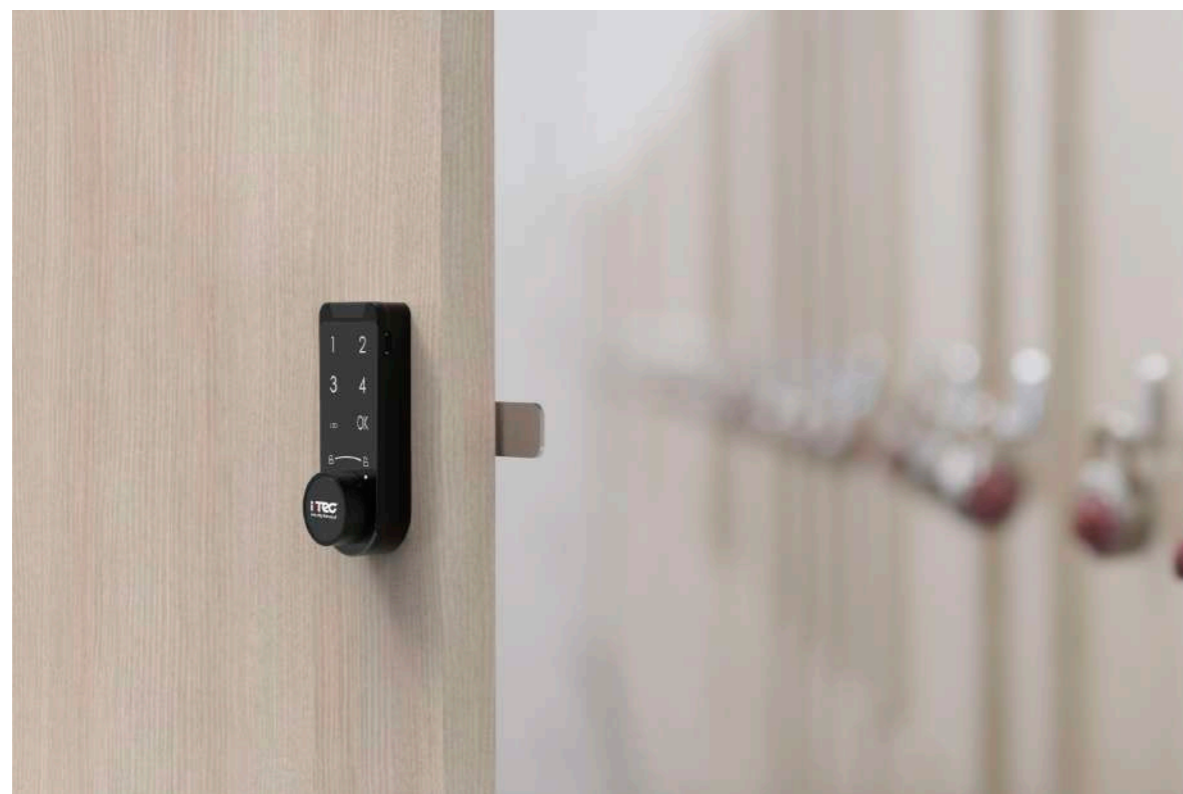

Ficha Técnica | Datasheet | Hoja Técnica | Fiche Technique

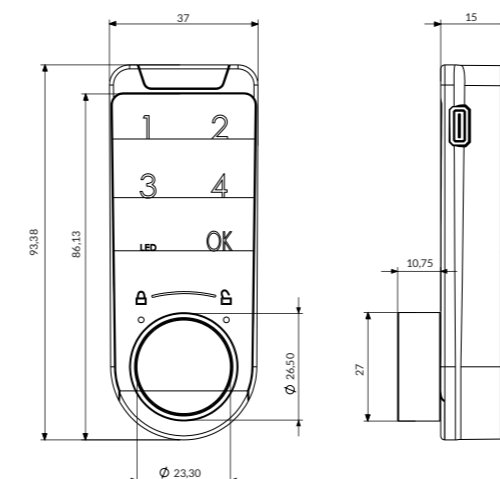

Standalone

**pt.**

Material	ABS
Método de Abertura	Código
Potência	DC 4,5v (AA*3)
Vida Útil da Bateria	~ 12 meses
Leds	Sim
Alarme de Bateria Fraca	3 Longos BIP
Consumo	260mA
Consumo Estático	7µA
Tempo Aberto	10s
Número de Aberturas	~ 2000 Aberturas (1 Ano)
Software	Não
Stand Alone	Sim
IP-Peso	IP56-0,2 Kg
Reconhecimento	0.5s
Resistencia à Humidade	< 95%
Temp. de Trabalho	-20°C ~ +70°C
Temp. de Armazenamento	-40°C ~ +80°C
Espessura da Porta	0,3mm a 20mm

es.

Material	ABS
Método de apertura	Código
Poder	DC 4.5v (AA * 3)
Duración de la batería	~ 12 meses
Leds	Si
Alarma de batería baja	3 BIP largos
El consumo	260mA
Consumo Estático	7µA
Tiempo abierto	10s
Numero de aperturas	~ 2000 aperturas (1 año)
Software	No
Estar solo	Si
IP-Peso	IP56-0,2 kg
Reconocimiento	0.5s
Resistencia a la humedad	< 95%
Temp. de trabajo	-20°C ~ + 70°C
Temp. Almacenamiento	-40°C ~ + 80°C
Espesor de la puerta	0,3mm - 20mm

en.

Material	ABS
Opening Method	Code
Power	DC 4,5v (AA*3)
Battery Lifetime	~ 12 months
Leds	Yes
Low Battery Alarm	3 Long tick before operation
Driving Consumption	260mA
Static Consumption	7µA
Open Time	7s
Number of openings	~ 2000 Openings (1 Year)
Software	No
Stand Alone	Yes
IP-Weight	IP 56-0,2 Kg
Recognition	0.5s
Resistance of Humidity	< 95%
Work Temperature	-20°C ~ +70°C
Storage Temperature	-40°C ~ +80°C
Door Thickness	0,3mm to 20mm

fr.

Matériel	ABS
Méthode d'ouverture	Code
Pouvoir	DC 4.5v (AA * 3)
Vie de la batterie	~ 12 mois
Leds	Oui
Alarme de batterie faible	3 long BIP
La consommation	260mA
Consommation statique	7µA
Temps ouvert	10s
Nombre d'ouvertures	~ 2000 ouvertures (1 an)
Logiciel	Non
Rester seul	Oui
IP-Le poids	IP56-0,2 kg
Reconnaissance	0.5s
Résistance à l'humidité	< 95%
Temp. De travail	-20°C ~ + 70°C
Temp. Stockage	-40°C ~ + 80°C
Porte épaisseur	0,3mm - 20mm

CB iOA®



pt. CB iOA é uma fechadura de cacifo aberta por RFID, código PIN ou ainda através de dispositivo móvel com o aplicativo iTEC OnAccess, trazendo todas as suas vantagens de solução online.

en. CB iOA is a locker lock opened by RFID, PIN code or via mobile device with the iTEC OnAccess, bringing all its advantages of an online solution.

es. CB iOA es un candado abierto por RFID, código PIN o dispositivo móvil con la aplicación iTEC OnAccess, que ofrece todas sus ventajas de una solución en línea.

fr. CB iOA est une serrure de casier ouverte par RFID, code PIN ou via un appareil mobile avec l'application iTEC OnAccess, apportant tous ses avantages d'une solution en ligne.

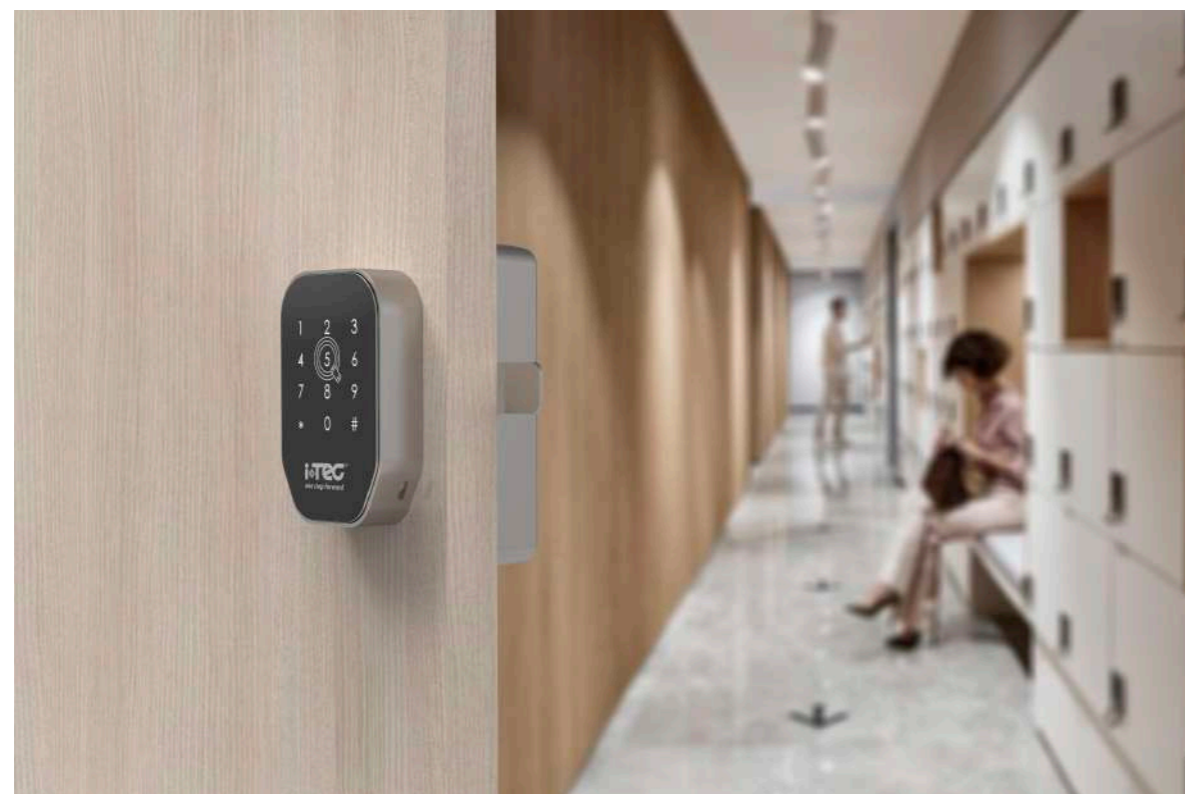

Ficha Técnica | Datasheet | Hoja Técnica | Fiche Technique

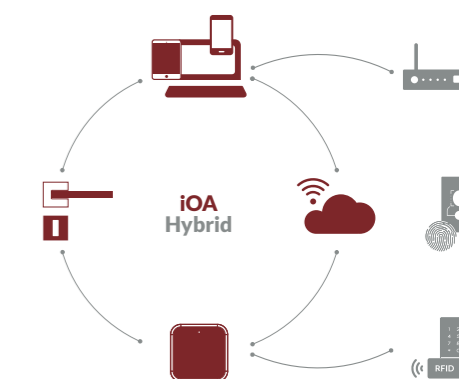
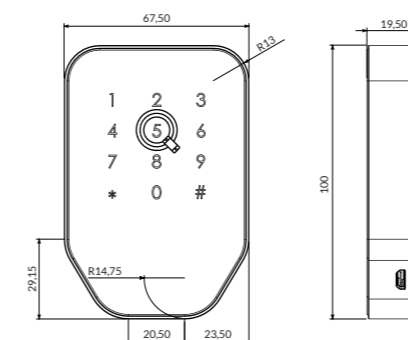
**pt.**

Material	Liga de Zinco, ABS
Método de Abertura	Bluetooth, Wifi, APP, Cartão
Potência	DC 6v (AA*4)
Máx. Potência	6V-MAX
Vida Útil da Bateria	~12 meses
Leds	Azul
Alarme de Bateria Fraca	Alarme de voz
Consumo	<200mA
Consumo Estático	65µA
Tempo Aberto	1.5s
Número de Aberturas	~5000 Aberturas (1Ano)
Software	iTEC iOA ; iOA PRO; iTEC HYBRID
Stand Alone	Sim
IP-Peso	IP56-0,450 Kg
Resistencia à Humidade	30%-95%
Temp. de Funcionamento	-20°C~+55°C
Nº de Código via APP	Ilimitado
Nº de Cód. auto-definido	150
Nº do cartões de IC	200
Níveis de Usuários	Sim
Código de Gestão	Sim

es.

Material	Aleación de zinc, ABS
Método de apertura	Bluetooth, Wifi, APP, Tarjeta
Poder	DC 6v (AA * 4)
Potencia máxima	6V-MAX
Duración de la batería	~ 12 meses
Leds	Azul
Alarma de batería baja	Alarma por voz
El consumo	<200mA
Consumo Estático	65µA
Tiempo abierto	1.5s
Numero de aperturas	~ 5000 aperturas (1 año)
Software	iTEC iOA ; iOA PRO; iTEC HYBRID
Estar solo	Si
IP	IP56-0,450 Kg
Resistencia a la humedad	30%-95%
Temp. de trabajo	-20°C~+55°C
Código No. a través de la APP	Ilimitado
Código autodefinido	150
Tarjeta IC No.	200
Niveles de usuario	Si
Código de gestión	Si

en.

Material	Zink Alloy, ABS
Opening Method	Bluetooth, Wifi, APP, Card
Power	DC 6v (AA*4)
Max. supply Power	6V-MAX
Battery Lifetime	~12 months
Leds	Blue
Low Battery alarm	Voice alarm
Driving Consumption	<200mA
Static Consumption	65µA
Open time	1.5s
Number of openings	~5000 Openings (1Year)
Software	iTEC iOA ; iOA PRO; iTEC HYBRID
Stand Alone	Yes
IP-Weight	IP56-0,450 Kg
Resistance of Humidity	30%-95%
Work Temperature	-20°C~+55°C
No. of code via APP	Unlimited
No. of self-defined code	150
No. of IC card	200
User Levels	Yes
Management Code	Yes

fr.

Matériel	Alliage de Zinc, ABS
Méthode d'ouverture	Bluetooth, Wifi, APP, Carte
Pouvoir	DC 6v (AA * 4)
Puissance Max.	6V-MAX
Vie de la batterie	~ 12 mois
Leds	Blue
Alarme de batterie faible	Alarme vocale
La consommation	<200mA
Consommation statique	65µA
Temps ouvert	1.5s
Nombre d'ouvertures	~ 5000 ouvertures (1 an)
Logiciel	iTEC iOA ; iOA PRO; iTEC HYBRID
Rester seul	Oui
IP-Le poids	IP56-0,450 Kg
Résistance à l'humidité	30%-95%
Temp. De travail	-20°C~+55°C
N ° de code via APP	Illimité
Code défini par vous-même	150
Numéro de carte IC	200
Niveaux d'utilisateur	Oui
Code de gestion	Oui

MEDC®



SSS

MTL



CE

RoHS

IP65

pt. A mola de porta automática MEDC é uma solução de instalação no superior da porta pelo interior. A sua principal característica "Touchless" uma vez integrada com as nossas soluções de controlo de acesso, permite destrancar e abrir uma porta sem qualquer interacção de toque com qualquer objecto.

en. The MEDC automatic door spring is a solution installed on the top of the door from the inside. Its main feature "Touchless" once integrated with our access control solutions, allows you to unlock and open a door without any touch interaction with any object.

es. El resorte de puerta automática MEDC es una solución de instalación en la parte superior de la puerta desde el interior. Su característica principal "Touchless", una vez integrada con nuestras soluciones de control de acceso, le permite desbloquear y abrir una puerta sin interacción táctil con ningún objeto.

fr. Le ressort de porte automatique MEDC est une solution installée sur le dessus de la porte de l'intérieur. Sa caractéristique principale «Touchless» une fois intégrée à nos solutions de contrôle d'accès, vous permet de déverrouiller et d'ouvrir une porte sans aucune interaction tactile avec aucun objet.

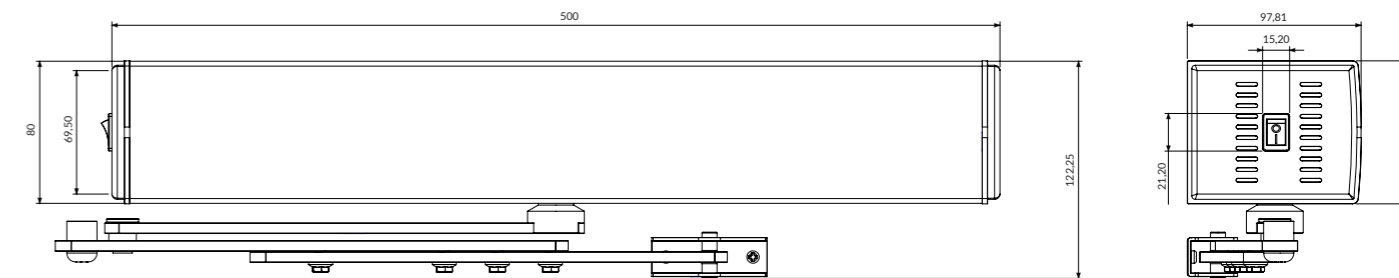

Ficha Técnica | Datasheet | Hoja Técnica | Fiche Technique

**pt.**

Material	Alumínio
Método de instalação	Placa
Ruído	<50 decibéis
Saída de trava elétrica	Dc 12V normalmente aberto
Tempo abertura e fecho	3 - 18 seg. ajustáveis
Alcance mínimo e máximo da abertura da porta	45° - 180° ajustável
Dispositivo de controle remoto	Super receptor heterodino, a distância efetiva de mais de 30m, decodificador de aprendizagem
Peso máximo da porta	100 Kg
Lagura máxima da porta	1200mm
Torque máximo da porta	75Nm
Peso	6 Kg
Fonte de energia	220V-110V
Corrente nominal	<1A
Força máxima	45W
Potência em Standby	<2W
Temperatura de trabalho	-40°C a 85°C
Índice de vida	A operação contínua de 3 milhões de vezes sem falha
Nível de proteção	IP 41

es.

Material	Aluminio
Metodo de instalacion	Junta
Ruido	<50 decibelios
Salida electrocerradura	DC 12V normalmente abierto
Hora de apertura y cierre	3 - 18 seg. ajustable
Rango mínimo y máximo de apertura de la puerta	45° - 180° orientable
Dispositivo de control remoto	Receptor súper heterodino, distancia efectiva de más de 30 m, decodificador de aprendizaje
Peso máximo de la puerta	100 kg
Ancho máximo de puerta	1200 mm
Par máximo de la puerta	75Nm
Peso	6 kg
Fuente de alimentación	220V-110V
Cadena nominal	<1A
Fuerza máxima	45W
Energía de reserva	<2W
Temperatura de trabajo	-40°C a 85°C
índice de vida	3 millones de veces operación continua sin fallas
Nivel de protecció	IP 41

en.

Material	Aluminum
Installation method	Board
Noise	<50 decibels
Electric lock output	DC 12V normally open
Opening and closing time	3 - 18 sec. adjustable
Minimum and maximum range of door opening	45° - 180° adjustable
Remote control device	Super heterodyne receiver, the effective distance of more than 30m, learning decoder
Max door weight	100 kg
Maximum door width	1200mm
maximum door torque	75Nm
Weight	6 kg
Power supply	220V-110V
Nominal chain	<1A
Maximum force	45W
Standby power	<2W
Work temperature	-40°C to 85°C
Life index	3 million times continuous operation without failure
Protection level	IP 41

fr.

Matériel	Aluminium
Méthode d'installation	Conseil
Ruido	<50 décibels
Salida electrocerradura	DC 12V normalement ouvert
Hora de apertura y cierre	3 - 18 s. Ajustable
Rango mínimo y máximo d'ouverture de la porte	45° - 180° réglable
Dispositif de contrôle à distance	Récepteur super hétérodyne, la distance effective de plus de 30 m, décodeur d'apprentissage
Peso maximum de la porte	100 kilogrammes
Ancho máximo de puerta	1200mm
Par maximo de la puerta	75Nm
Peso	6 kg
Source d'alimentation	220V-110V
Cadène nominale	<1A
Fuerza maxima	45W
Energie de réserve	<2W
Température de trabalho	-40°C à 85°C
índice de vie	3 millions de fois en fonctionnement continu sans panne
Niveau de protection	IP 41

MEFL®



SSS

MTL



CE

RoHS

IP65

pt. MEFL é uma mola de porta automática embutida no piso, com um design que oferece adaptabilidade a praticamente qualquer instalação. Com a vantagem de poder integrar o sistema com nossas soluções de controle de acesso, torna o MEFL uma solução “sem contato” ideal para prevenir a propagação de bactérias e vírus.

en. MEFL is an automatic door spring embedded in the floor, with a design that offers adaptability to almost any installation. With the advantage of being able to integrate system with our access control solutions, it makes MEFL an ideal “touchless” solution for preventing the spread of bacteria and viruses.

es. MEFL es un resorte de puerta automático incrustado en el piso, con un diseño que ofrece adaptabilidad a casi cualquier instalación. Con la ventaja de poder integrar el sistema con nuestras soluciones de control de acceso, hace de MEFL una solución ideal “sin contacto” para prevenir la propagación de bacterias y virus.

fr. MEFL est un ressort de porte automatique encastré dans le sol, avec une conception qui offre une adaptabilité à presque toutes les installations. Avec l'avantage de pouvoir intégrer le système à nos solutions de contrôle d'accès, il fait d'« MEFL une solution « sans contact » idéale pour prévenir la propagation des bactéries et des virus.



MEFL®

Ficha Técnica

Datasheet

Hoja Técnica

Fiche Technique

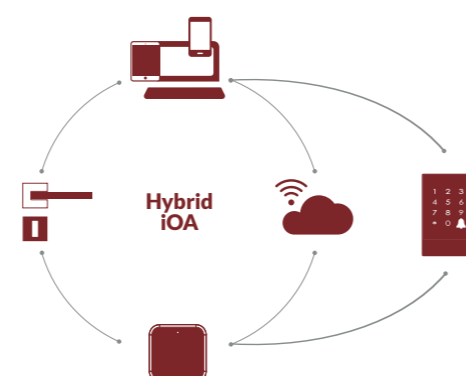

pt.

Modelo	Versão 1	Versão 2	Versão 3	Versão 4
Material	Ferro/SSS	Ferro/SSS	Ferro/SSS	Ferro/SSS
Direção de abertura	Única	Única	Única	Dupla
Tamanho do motor	296x132x84mm	296x132x84mm	358x184x108mm	310x170x85mm
Peso	6,5Kg	6,5Kg	11,5Kg	9Kg
Distância entre eixos	70mm	70mm	110mm	70mm
Máx. peso da porta	100Kg	150Kg	200Kg	100Kg
Largura máxima da porta	1000mm	2000mm	1500mm	1200mm
Força máxima de torque	75Nm	110Nm	165Nm	75Nm
Potência máxima	35W	35W	55W	55W
Potência em Standby			<6W	
Temperatura de trabalho			-40-85°C	
Ruído			<55dB	
Indicação LED			Luz de alimentação Luz de entrada externa Luz de status	
Tela digital			Configuração de parâmetro do display digital e código de erro	
Tipo de instalação			Embutido	
Fonte de energia			220V-110V	
Nível de proteção			IP55	

en.

Model	Version 1	Version 2	Version 3	Version 4
Material	Iron/SSS	Iron/SSS	Iron/SSS	Iron/SSS
Opening direction	Only	Only	Only	Pair
Engine size	296x132x84mm	296x132x84mm	358x184x108mm	310x170x85mm
Weight	6.5 kg	6.5 kg	11.5 kg	9 kg
Length between the axis	70mm	70mm	110mm	70mm
Max door weight	100kg	150Kg	200kg	100kg
Max door width	1000mm	2000mm	1500mm	1200mm
maximum torque force	75Nm	110Nm	165Nm	75Nm
Maximum power	35W	35W	55W	55W
Standby power			<6W	
Work temperature			-40-85°C	
Noise			<55 dB	
LED indication			power light external entry light status light	
Digital screen			Digital display parameter setting and error code	
Installation type			inlaid	
Power supply			220V-110V	
protection level			IP55	

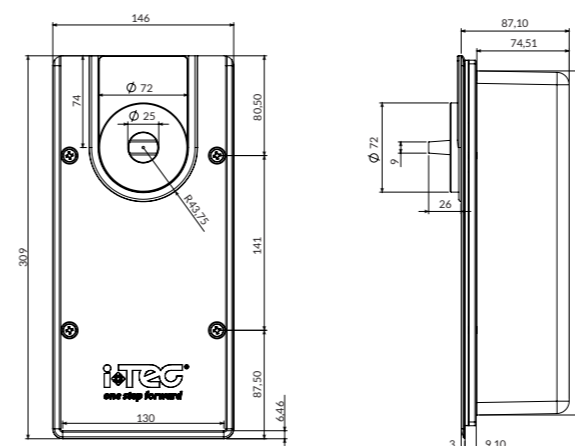

es.

Modelo	Versión 1	Versión 2	Versión 3	Versión 4
Material	Hierro/SSS	Hierro/SSS	Hierro/SSS	Hierro/SSS
Dirección de apertura	Solo	Solo	Solo	Par
Tamaño de la maquina	296x132x84mm	296x132x84mm	358x184x108mm	310x170x85mm
Peso	6,5 kg	6,5 kg	11,5 kg	9 kg
Longitud entre el eje	70 mm	70 mm	110 mm	70 mm
Peso máximo de la puerta	100 kg	150Kg	200kg	100 kg
Ancho máximo de la Puerta	1000 mm	2000 mm	1500 mm	1200 mm
Fuerza de torsión máxima	75Nm	110Nm	165Nm	75Nm
Poder maximo	35W	35W	55W	55W
Energía de reserva			<6W	
Temperatura de trabajo			-40-85°C	
Estamos			<55dB	
Indicación LED			Luz de encendido Luz de entrada exterior Luz de estado	
Pantalla digital			Configuración de parámetros de pantalla digital y código de error	
Tipo de instalación			Incrustado	
Fuente de alimentación			220V-110V	
Nivel de protección			IP55	

fr.

Modèle	Version 1	Version 2	Version 3	Version 4
Matériel	Fer/SSS	Fer/SSS	Fer/SSS	Fer/SSS
Sens d'ouverture	Seul	Seul	Seul	Paire
Taille de l'appareil	296x132x84mm	296x132x84mm	358x184x108mm	310x170x85mm
Poids	6,5 kg	6,5 kg	11,5 kg	9kg
Longueur entre axe	70mm	70mm	110mm	70mm
Poids de la porte	100kg	150Kg	200kg	100 kg
Largeur de porte	1000mm	2000mm	1500mm	1200mm
Force de couple maximale	75Nm	110Nm	165Nm	75Nm
Puissance maximum	35W	35W	55W	55W
Alimentation de secours			<6W	
Température de travail			-40-85°C	
Nous sommes			<55dB	
Indicateur LED			Lumière de puissance Lumière d'entrée extérieure Voyant d'état	
Écran numérique			Paramétrage de l'affichage numérique et code d'erreur	
Type d'installation			Embarqué	
Source de courant			220V-110V	
Niveau de protection			IP55	

iViewer 02HD v2.0[®]

3MP



pt. Com iViewer 02 HD v2.0 consegue ver quem se encontra à sua porta com máxima segurança. Guardando registos dos visitantes, através do sensor de proximidade, podendo optar por foto ou vídeo, consultando no próprio dispositivo quem esteve à sua porta.

en. With iViewer 02 HD v2.0 can see who is at your door with maximum security. Storing visitor records, through proximity sensor, can choose photo or video, querying on the device itself who was at your door.

es. Con iViewer 02 HD v2.0 puede ver quién está en su puerta con la máxima seguridad. Almacenar registros de visitantes, a través del sensor de proximidad, puede elegir fotos o videos, consultando en el propio dispositivo que estaba en su puerta.

fr. Avec iViewer 02 HD v2.0 pouvez voir qui est à votre porte avec une sécurité maximale. Le stockage des dossiers des visiteurs, par le biais d'un capteur de proximité, peut choisir une photo ou une vidéo, en interrogeant sur l'appareil lui-même qui était à votre porte.

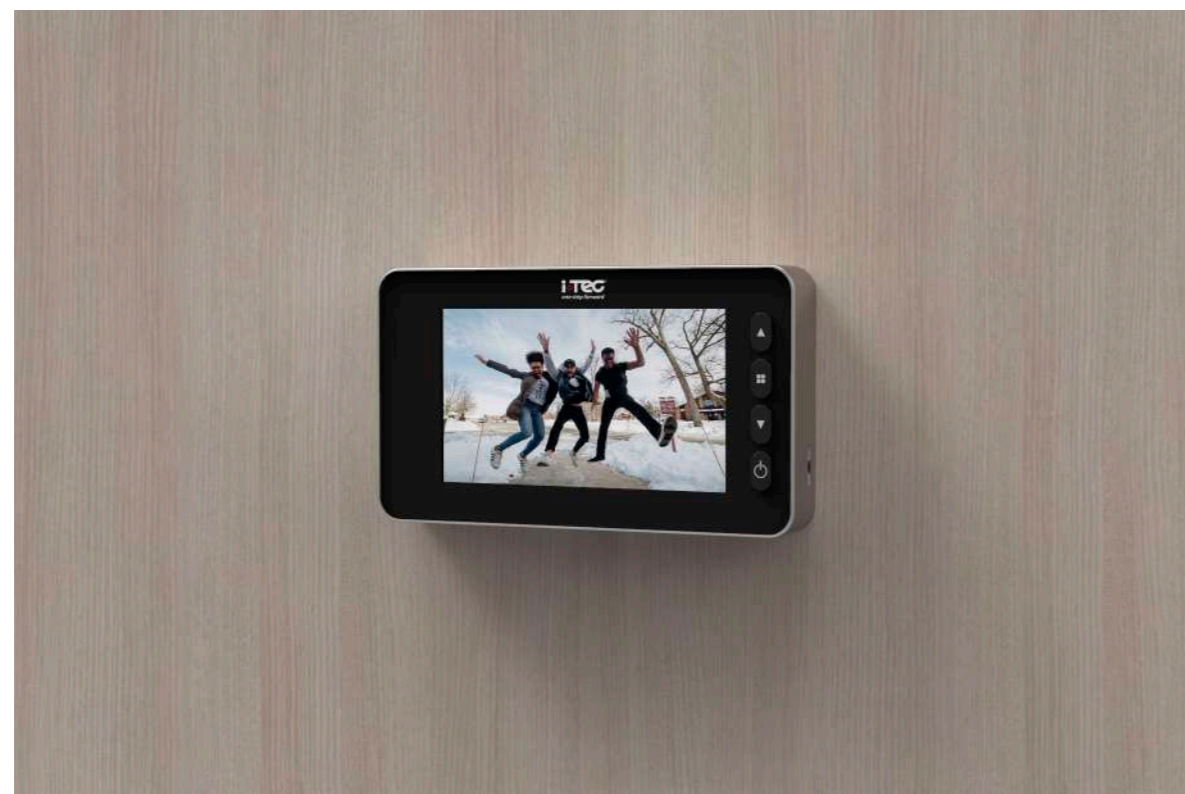

Ficha Técnica | Datasheet | Hoja Técnica | Fiche Technique

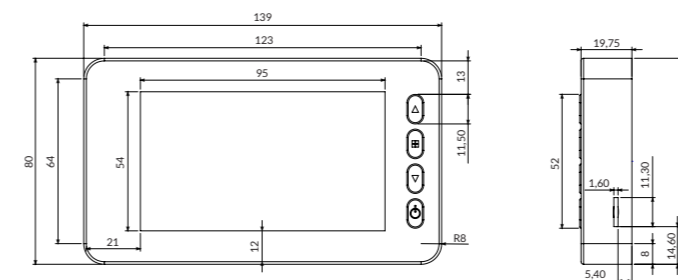
**pt.**

Material	ABS
Função	Campainha; Sensor de movimento Foto - video
Câmara	3MP HD
LCD	4.3" TFT
Cartão Micro	16GB
Potência	4*AA
Vida Útil da Bateria	~ 12 meses
Consumo	350mA
Consumo Estático	15µA
Infravermelho	940nM
Capacidade Fotos	2000
Visão Noturna	Sim
Detector de Movimento	Sim
Armazenamento	Sim
Humidade	< 98%
Temp. Trabalho	-30°C ~ +65°C
Temp. Armazenamento	-30°C ~ +65°C
Diâmetro da Abertura	14mm - 26mm
Espessura da Porta	38mm - 110mm
Peso	0,32 Kg
Cores Disponíveis	Cinza; Preto; Champaign; Rosa

es.

Material	ABS
Función	Timbre; Sensor de movimiento Foto/Video
Cámara	3MP HD
LCD	TFT de 4.3'
Tarjeta micro	16GB
Poder	4 * AA
Duración de la batería	~ 12 meses
El consumo	350mA
Consumo Estático	15µA
Infrarrojo	940nM
Fotos de capacidad	2000
Visión nocturna	Si
Detector de movimiento	Si
Almacenamiento	Si
Humedad	< 98%
Temp. Trabajo	-30°C ~ +65°C
Temp. Almacenamiento	-30°C ~ +65°C
Diámetro de apertura	14mm - 26mm
Espesor de la puerta	38mm - 110mm
Peso	0,32 kg
Colores disponibles	Gris; Negro; Champaña

en.

Material	ABS
Function	Bell; Motion sensor; Photo / Video
Camera	3MP HD
LCD	4.3" TFT
Micro Card	16GB
Power	4*AA
Battery Lifetime	~ 12 months
Consumption	350mA
Static Consumption	15µA
Infrared	940nM
Photo Capacity	2000
Nightvision	Yes
Movement Detector	Yes
Storage	Yes
Resistance of Humidity	< 98%
Work Temperature	-30°C ~ +65°C
Storage Temperature	-30°C ~ +65°C
Door barrel diameter	14mm - 26mm
Door Thickness Request	38mm - 110mm
Weight	0,32 Kg
Colors Available	Grey; Black; Champaign

fr.

Matériel	ABS
Fonction	Cloche; Capteur de mouvement Photo/Vidéo
Appareil photo	3MP HD
LCD	TFT 4.3'
Micro carte	32 Go
Pouvoir	4 * AA
Vie de la batterie	~ 12 mois
La consommation	350mA
Consommation statique	15µA
Infrarouge	940nM
Capacité photo	2000
Vision nocturne	Oui
Détecteur de mouvement	Oui
Stockage	Oui
Résistance à l'humidité	< 98%
Température de travail	-30°C ~ +65°C
Température de stockage	-30°C ~ +65°C
Diamètre de la porte	14mm - 26mm
D'épaisseur de porte	38mm - 110mm
Poids	0,32 kg
Couleurs Disponibles	Gris; Noir; Champaign;

iViewer 03ECO®



3MP

2.6"

2x
AA

CE

RoHS

FC

pt. O iViewer 03Eco é mais económico da sua gama. Contudo, também desempenha a sua função principal com uma grande simplicidade.

en. The iViewer 03Eco is the more economical in its class. However, it also performs its core function with great simplicity.

es. El iViewer 03Eco es mas economico en su gama. No obstante, tambien desempeña a su función principal con una grande simplicidad.

fr. L'iViewer 03Eco est le plus économique de sa catégorie. Cependant, il exécute également sa fonction principale avec une grande simplicité.

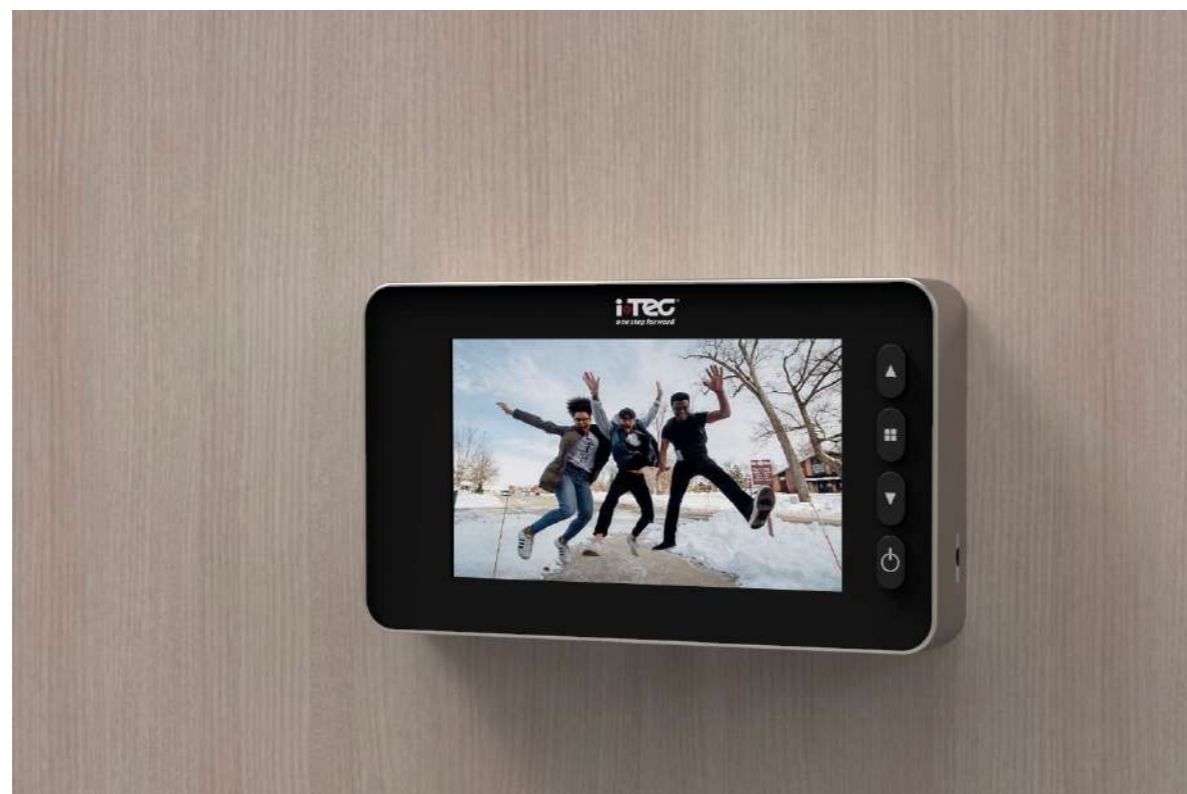

Ficha Técnica | Datasheet | Hoja Técnica | Fiche Technique

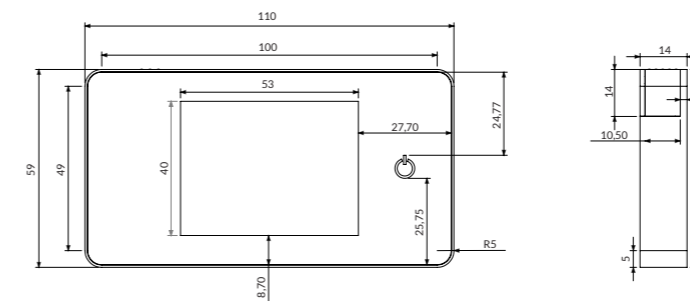
**pt.**

Material	ABS
Função	Visor digital
Câmara	1.3MP HD
LCD	2.6" TFT
Potência	2*AA
Vida Útil da Bateria	~ 12 meses
Consumo	350mA
Consumo Estático	15µA
Humidade	< 98%
Temp. Trabalho	-30°C ~ +65°C
Temp. Armazenamento	-30°C ~ +65°C
Diâmetro da Abertura	14mm - 26mm
Espessura da Porta	38mm - 110mm
Peso	0,18 Kg
Cores Disponíveis	Branco Cinza Preto Champaign Dourado

es.

Material	ABS
Función	Visor digital
Cámara	1.3MP HD
LCD	2.6" TFT
Poder	2 * AA
Duración de la batería	~ 12 meses
El consumo	350mA
Consumo Estático	15µA
Humedad	< 98%
Temp. Trabajo	-30°C ~ + 65°C
Temp. Almacenamiento	-30°C ~ + 65°C
Diámetro de apertura	14mm - 26mm
Espesor de la puerta	38mm - 110mm
Peso	0,18 kg
Colores disponibles	Blanco Gris Negro Champaña Dorado

en.

Material	ABS
Function	Digital display
Camera	3MP HD
LCD	2.6" TFT
Power	2*AA
Battery Lifetime	~ 12 months
Consumption	350mA
Static Consumption	15µA
Resistance of Humidity	< 98%
Work Temperature	-30°C ~ +65°C
Storage Temperature	-30°C ~ +65°C
Door barrel diameter	14mm - 26mm
Door Thikness Request	38mm - 110mm
Weight	0,18 Kg
Colors Available	White Grey Black Champaign Golden

fr.

Matériel	ABS
Fonction	Visionneuse numérique
Appareil photo	1.3MP HD
LCD	2.6" TFT
Pouvoir	2 * AA
Vie de la batterie	~ 12 mois
La consommation	350mA
Consommation statique	15µA
Humidité	< 98%
Temp. Travail	-30°C ~ + 65°C
Temp. Stockage	-30°C ~ + 65°C
Diamètre d'ouverture	14mm - 26mm
Porte épaisseur	38mm - 110mm
Le poids	0,18 kg
Couleurs Disponibles	Blanc Gris Noir Champaña Doré



pt. O iHUB 03 é a versão mais inovadora e recente com um novo design modular. Bastante versátil, oferece streaming Bluetooth, uma entrada USB para carregamento rápido de todos os seus dispositivos eletrônicos e outra para Plug & Play, para ver vídeos, filmes, imagens, jogar, fazer videochamadas.

en. The iHUB 03 is the most innovative and latest version with a new modular design. Versatile, offers Bluetooth streaming, a USB port for fast charging of all your electronic devices and one for Plug & Play, to watch videos, movies, pictures, play, make video calls. With a front HDMI input allows portable computers connection and peripherals with HDMI.

es. El iHUB 03 es la versión más innovadora y reciente con un nuevo diseño modular. Bastante versátil, ofrece streaming Bluetooth, una entrada USB para una carga rápida de todos los dispositivos electrónicos y otra para Plug & Play, para ver videos, películas, juegos y hacer video llamadas. Con una entrada HDMI frontal posibilita la conexión de ordenadores portátiles.

fr. Le iHUB 03 est la version la plus innovante et la plus récente avec un nouveau design modulaire. Versatile, il offre le streaming par Bluetooth, une porte USB pour une recharge rapide de tous vos appareils électroniques et une pour Plug & Play, pour regarder des vidéos, des films, des images, des jeux, faire des appels vidéo.

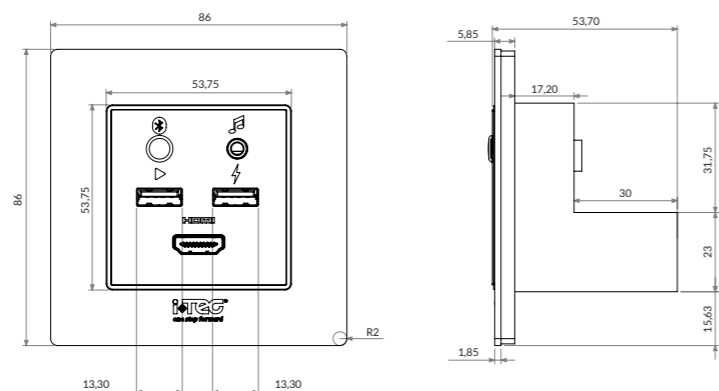

Ficha Técnica | Datasheet | Hoja Técnica | Fiche Technique

pt.

Material ABS, Alumínio
Fornecedor de energia 100-240V 50/60Hz 0.4A
Potência 12V 1.5A
Cores disponíveis Vermelho, Amarelo, Verde
 Branco, Cinzento, Preto
 Champaign, Dourado

es.

Material ABS, aluminio
Proveedor de energía 100-240V 50 / 60Hz 0.4A
Poder 12V 1.5A
Colores disponibles Rojo, Amarillo, Verde
 Blanco, Gris, Negro
 Champaña, Dorado

en.

Material ABS, Aluminium
Power Supplier 100-240V 50/60Hz 0.4A
Power 12V 1.5A
Colors Available Red, Yellow, Green
 White, Grey, Black
 Champagne, Golden

fr.

Matériel ABS, aluminium
Fournisseur d'électricité 100-240V 50 / 60Hz 0.4A
Pouvoir 12V 1.5A
Couleurs disponibles Rouge, Jaune, Vert
 Blanc, Gris, Noir
 Champaign, Doré

iTB 01®

Campainha elétrica com "Do not Disturb" | Electric door bell with "Do not Disturb" | Timbre eléctrico con "Do not Disturb" | Sonnette électrique avec "Ne pas déranger"

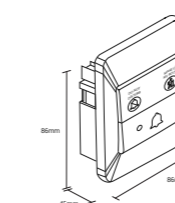

Material/Matériau ABS
Cor/Color/Couleur Branco/White/Blanco/Blanc
Peso/Weight/Poids 200g
Voltagem/Voltage/Voltaje/Tension CA 220V
Corrente/Current/Corriente/Courant 30A
Potência/Power/Energia/Énergie 6600
Consumo/Consumption/Consommation 0.01W
Tempo Ligado/On Time/A Tiempo/À Temps ~15s



iT 01®

Interruptor economizador de energia | Energy saving switch | Interruptor economizador de energia | Commutateur d'économie d'énergie

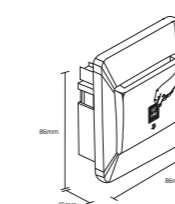

Material/Matériau ABS
Cor/Color/Couleur Branco/White/Blanco/Blanc
Peso/Weight/Poids 200g
Voltagem/Voltage/Voltaje/Tension CA 220V
Corrente/Current/Corriente/Courant 30A
Potência/Power/Energia/Énergie 6600
Consumo/Consumption/Consommation 0.01W
Tempo Ligado/On Time/A Tiempo/À Temps ~15s



iT 02®

Interruptor economizador de energia com iCard | Energy saving switch triggered with iCard | Interruptor economizador de energia com iCard | Commutateur d'économie d'énergie déclenché avec iCard

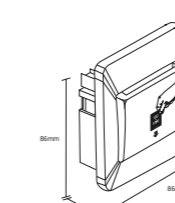

Material/Matériau ABS
Cor/Color/Couleur Branco/White/Blanco/Blanc
Peso/Weight/Poids 200g
Voltagem/Voltage/Voltaje/Tension CA 220V
Corrente/Current/Corriente/Courant 30A
Potência/Power/Energia/Énergie 6600
Consumo/Consumption/Consommation 0.01W
Tempo Ligado/On Time/A Tiempo/À Temps ~15s



iT 03®

Interruptor economizador de energia com iCard e hora de Check-Out | Energy saving switch triggered with iCard and Check-out time | Interruptor economizador de energia com iCard y hora de Check-Out | Commutateur d'économie d'énergie déclenché avec iCard et heure de départ

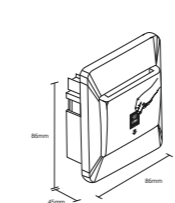

Material/Matériau ABS
Cor/Color/Couleur Branco/White/Blanco/Blanc
Peso/Weight/Poids 200g
Voltagem/Voltage/Voltaje/Tension CA 220V
Corrente/Current/Corriente/Courant 30A
Potência/Power/Energia/Énergie 6600
Consumo/Consumption/Consommation 0.01W
Tempo Ligado/On Time/A Tiempo/À Temps ~15s



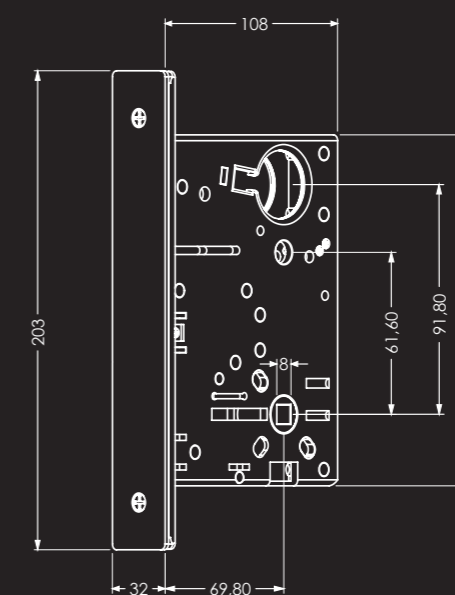
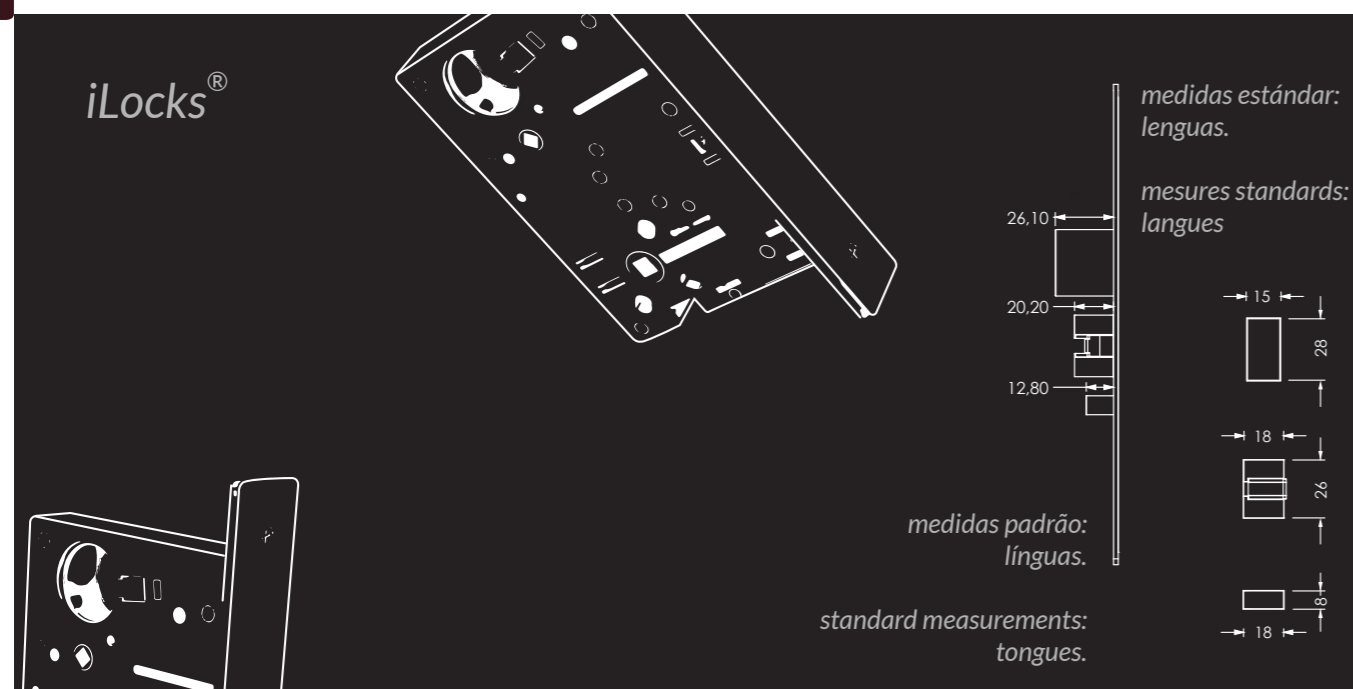

medidas padrão: corpo da
fechadura.
sem línguas.

standard measurements:
lock body.
no tongues.

medidas estándar:
cuerpo de la cerradura.
sin lenguas.

Mesures standard: corps
de serrure.
pas de langues.



ANSI N801®

Passagem/ Passage / Paso / Passage

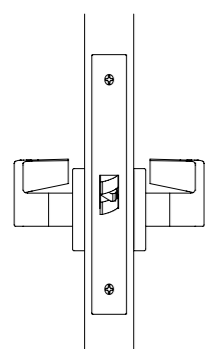

pt. Modelo de passagem: Trava.
Abertura por maçaneta ou botão giratório, sempre aberto.

en. Step model: Latch.
Opening by handle or rotary knob, always open.

es. Modelo de paso: Pestillo. Apertura mediante manija o botón giratorio, siempre abierto.

fr. Modèle pas à pas: Loquet.
Ouverture par poignée ou bouton rotatif, toujours ouvert.



SSS

aço inox acetinado acero inoxidable satin
satin stainless steel acier inoxydable satiné

AISI 304



ANSI N804®

Entrada / Entry / Entrada / Entrée

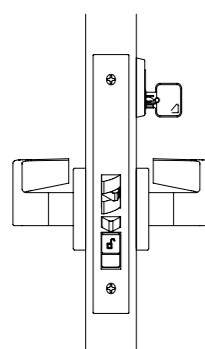

en. Trava acionada pelo botão giratório interno ou pela maçaneta, excepto se a maçaneta externa estiver travada pelo botão giratório. Manípulo interior sempre aberto,

en. Locking handle and cylinder latch. Latch lock activated by the inner rotary knob or the handle, except if the outer handle is locked by the rotary knob. Internal knob and knob, always open.

es. Mango de bloqueo y pestillo mediante cilindro. Cerradura de pestillo activada por el mando giratorio interior o la manija, excepto si la manija exterior está bloqueada por el mando giratorio. Pomo y pomo internos, siempre abiertos.

es. Poignée de verrouillage et loquet à cylindre. Verrouillage du pêne demi-tour activé par le bouton rotatif intérieur ou la poignée, sauf si la poignée extérieure est verrouillée par le bouton rotatif. Bouton interne et bouton, toujours ouverts.



ANSI N805®

Sala de aula/ Classroom / Salón de Clases / Sale de Classe

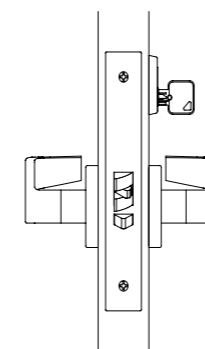

en. Lingueta auxiliar. Feche-a de cada lado, a menos que a alavanca externa esteja travada pelo cilindro com chave. O puxador permanecerá fechado até destravar com uma chave.

en. Auxiliary tab. Close the locking tab on each side unless the outer lever is locked by the keyed cylinder. The handle on the outside remains closed unless unlocked with a key.

es. Lengüeta auxiliar. Ciérralo por cada lado a menos que la palanca exterior esté bloqueada por el cilindro con llave. La manija permanecerá cerrada hasta que se desbloquee con una llave.

es. Langue auxiliaire. Fermez-le de chaque côté à moins que le levier extérieur ne soit verrouillé par le cylindre à clé. La poignée restera fermée jusqu'à ce qu'elle soit déverrouillée avec une clé.



SSS

aço inox acetinado acero inoxidable satin
satin stainless steel acier inoxydable satiné

AISI 304



ANSI N807®

Armazém / Storeroom / Trastero / Stockage

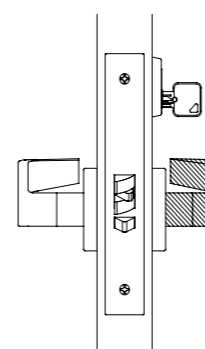

pt. Lingueta de travamento auxiliar. Pode ser trancada por dentro ou com uma chave por fora. O puxador externo é fixo. A lingueta auxiliar bloqueia a principal. Punho interno, sempre aberto.

en. Auxiliary locking tab. It can be locked from the inside or with a key from the outside. The external handle is always fixed. The auxiliary latch blocks the primary. Inner handle, always open.

es. Lengüeta de bloqueo auxiliar. Se cierra por dentro o con llave por fuera. El mango externo siempre es fijo. El lengüeta auxiliar bloquea el principal. Asa interior, siempre abierta.

fr. Languette de verrouillage auxiliaire. Se verrouille à l'intérieur ou se verrouille à l'extérieur. La poignée externe est toujours fixe. L'onglet auxiliaire bloque le principal. Poignée intérieure, toujours ouverte.





ANSI N813[®]

Dormitório / Dormitory / Dormitorio / Dortoir

pt. Língua e trava. A trava é ativada pelo puxador. A fechadura é aberta com a maçaneta ou com o "botão" de dentro. Abertura interior total a partir do interior através do puxador.

en. Tongue and latch. The latch is activated by the handle. The lock is opened with the handle or with the "button" inside. Full interior opening from the inside through the handle.

es. Lengua y pestillo. El pestillo se activa mediante la manija. La cerradura se abre con la manija o con el "botón" en el interior. Apertura interior completa desde el interior a través del tirador.

fr. Languette et loquet. Le loquet est activé par la poignée. La serrure s'ouvre avec la poignée ou avec le « bouton » à l'intérieur. Ouverture intérieure complète de l'intérieur par la poignée.

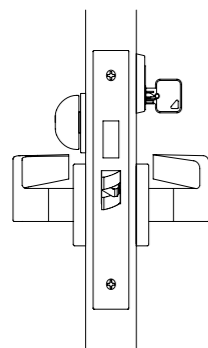

SSS

aço inox acetinado acero inoxidable satin
satin stainless steel acier inoxydable satiné

AIISI 304



ANSI N815[®]

Hotel e Motel / Hotel and Motel / Hotel y Motel / Hôtel et Motel

pt. Língua e trava. A trava é ativada pelo puxador. A fechadura é aberta com a maçaneta ou com o "botão" de dentro. Abertura interior total através do puxador.

en. The lock tongue is operated with the cylinder key or the handle inside, unless locked with the emergency key. The outer handle is always inactive. Turning the inner knob opens the tab and latch.

es. La lengüeta de la cerradura se opera con la llave del cilindro o la manija en el interior, a menos que se bloquee con la llave de emergencia. El mango externo siempre está inactivo.

fr. La lengüeta de la cerradura se opera con la llave del cilindro o la manija en el interior, a menos que se bloquee con la llave de emergencia. El mango externo siempre está inactivo.

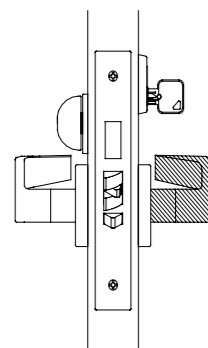

SSS

aço inox acetinado acero inoxidable satin
satin stainless steel acier inoxydable satiné

AIISI 304



ANSI N819[®]

Privacidade / Privacy / Intimidad / Intimité

pt. A lingueta de trava abre em ambos os lados da porta, a menos que a maçaneta interna seja fechada por dentro. Com chave de desbloqueio específica para abertura de emergência no exterior.

en. The lock tab opens on both sides of the door, unless the interior knob is closed from the inside. With specific unlocking key for emergency opening outside.

es. La lengüeta de la cerradura se abre en ambos lados de la puerta, a menos que la perilla interior se cierre desde adentro. Con llave de desbloqueo específica para apertura de emergencia en el exterior.

fr. La languette de verrouillage s'ouvre des deux côtés de la porte, sauf si le bouton intérieur est fermé de l'intérieur. Avec clé de déverrouillage spécifique pour ouverture d'urgence à l'extérieur.

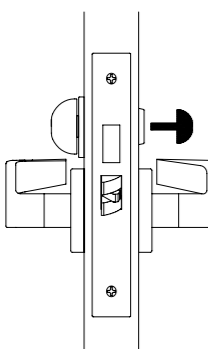

ANSI N820[®]

Apartment / Departamento

pt. Abertura da lingueta da fechadura com o puxador, por dentro ou por fora, a menos que a fechadura seja fechada com a chave cilíndrica ou o botão interno.

en. Opening of the lock tongue with the handle, from the inside or outside, unless the lock is closed with the cylinder key or the inside button.

es. Apertura de la lengüeta de la cerradura con la manija, desde el lado interior o exterior, a menos que la cerradura se cierre con la llave cilíndrica o el botón interior.

fr. Ouverture du pêne de la serrure avec la poignée, de l'intérieur ou de l'extérieur, sauf si la serrure est fermée avec la clé à cylindre ou le bouton intérieur.

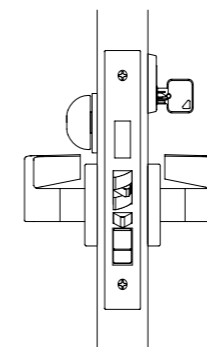

SSS

aço inox acetinado acero inoxidable satin
satin stainless steel acier inoxydable satiné

AIISI 304



ANSI N822[®]

Privacy / Intimidad

pt. Trava. A trava da fechadura é acionada pelo puxador em ambos os lados da fechadura, a menos que seja fechada com o botão interno. O puxador interno abre sempre a fechadura.

en. Lock latch. The lock latch is activated by the handle on both sides of the lock, unless closed with the inner button, the inner knob always opens the lock.

es. Pestillo de bloqueo. El pestillo de la cerradura se activa mediante la manija en ambos lados de la cerradura, a menos que se cierre con el botón interior, la perilla interior siempre abre la cerradura.

fr. Loquet. Le loquet de verrouillage est activé par la poignée des deux côtés de la serrure, sauf s'il est fermé avec le bouton intérieur, le bouton intérieur ouvre toujours la serrure.

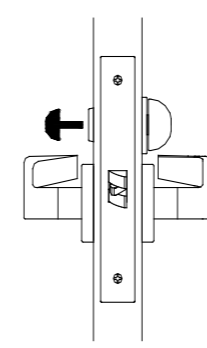

SSS

aço inox acetinado acero inoxidable satin
satin stainless steel acier inoxydable satiné

AIISI 304



ANSI N840[®]

Entry-Office / Entrada-Oficina

pt. A lingueta de travamento é ativada pelo botão interno e externo, a menos que o botão externo seja travado com a chave. A lingueta da fechadura é acionada pela chave cilíndrica ou pelo puxador interno.

en. The lock tongue is activated by the inner and outer knob, unless the outer knob is locked with the key. The lock tongue is activated by the cylinder key or the internal handle.

es. La lengüeta de la cerradura se activa mediante la perilla interior y exterior, a menos que la perilla exterior esté bloqueada con la llave. La lengüeta se activa mediante la llave del cilindro o el mango interno.

fr. Loquet auxiliaire. La languette de verrouillage est activée par le bouton intérieur et extérieur, à moins que le bouton extérieur ne soit verrouillé avec la clé. La languette de la serrure est activée par la clé à cylindre ou la poignée intérieure.

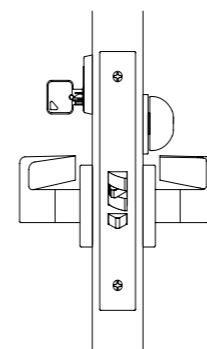



iC60x72[®] SP

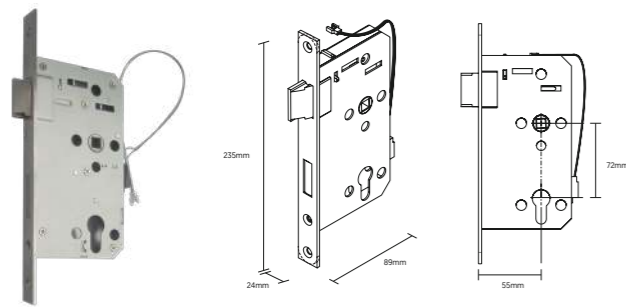

iC60x72[®] RP

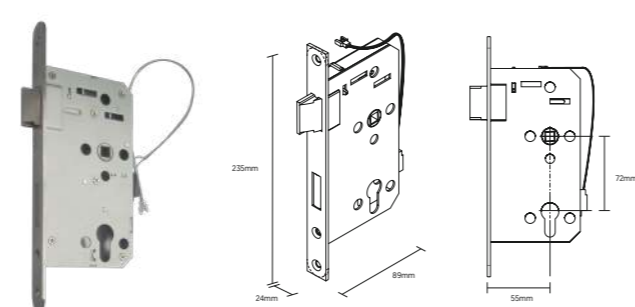

SSS

aço inox acetinado acero inoxidable satin
satin stainless steel acier inoxydable satiné

AISI 304



iK02 55x72[®] SP

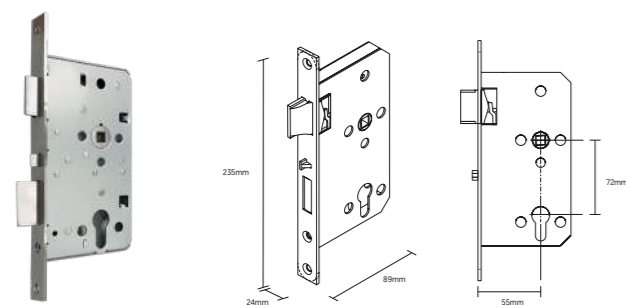

iK02 55x72[®] RP

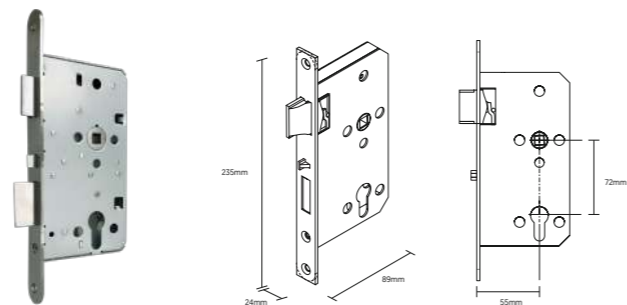

SSS

aço inox acetinado acero inoxidable satin
satin stainless steel acier inoxydable satiné

AISI 304



Solenoid BT[®]

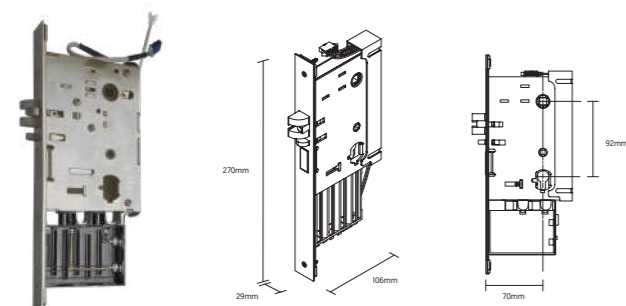

Ansi 01[®]

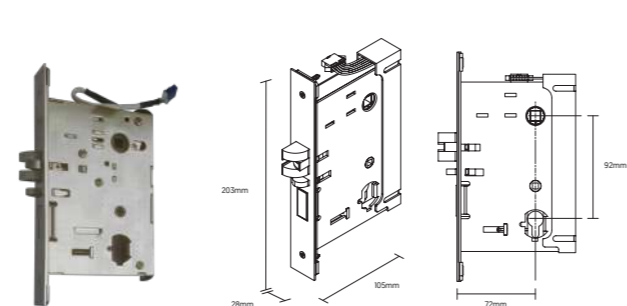

Ansi 02[®]

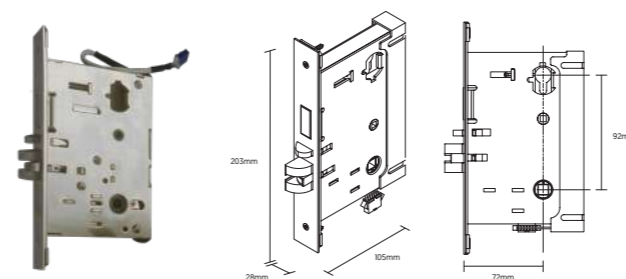

Ansi EU[®]

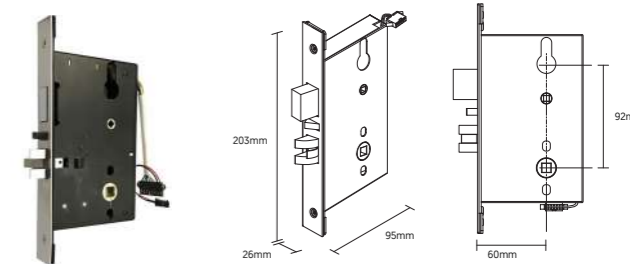

SSS

aço inox acetinado acero inoxidable satin
satin stainless steel acier inoxydable satiné

AISI 304



Eur Sole 60x72[®]

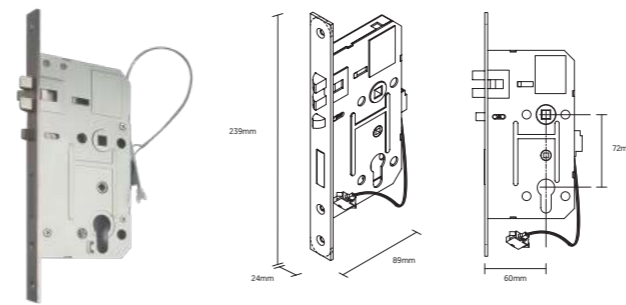

Eur Sole 60x72[®]

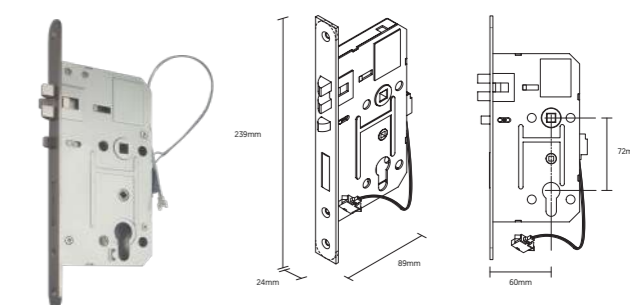

SSS

aço inox acetinado acero inoxidable satin
satin stainless steel acier inoxydable satiné

AISI 304



Euro Meca 60x72[®]

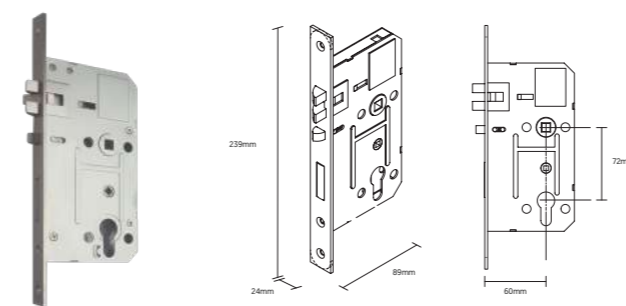

Euro Mec[®] RP

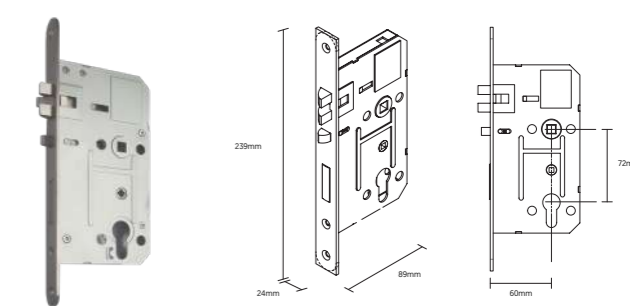

Anti Panic Bar®

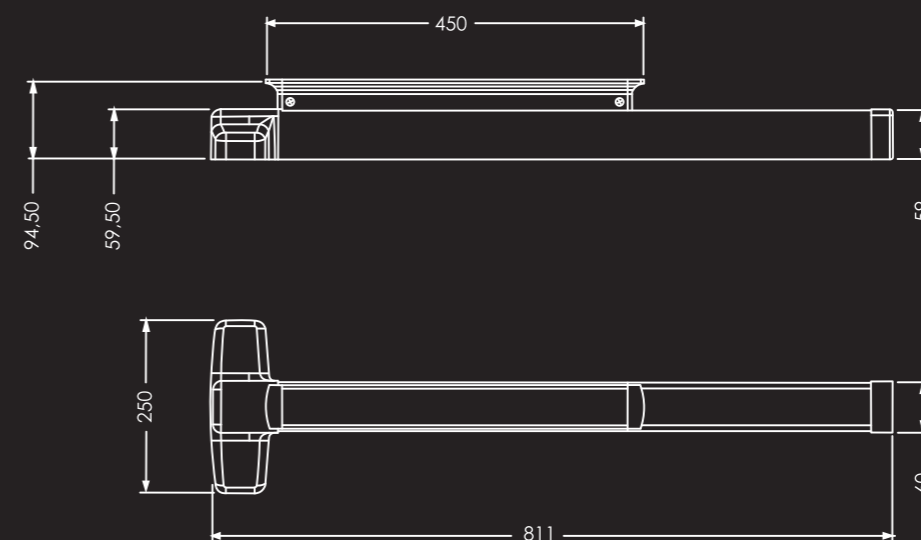
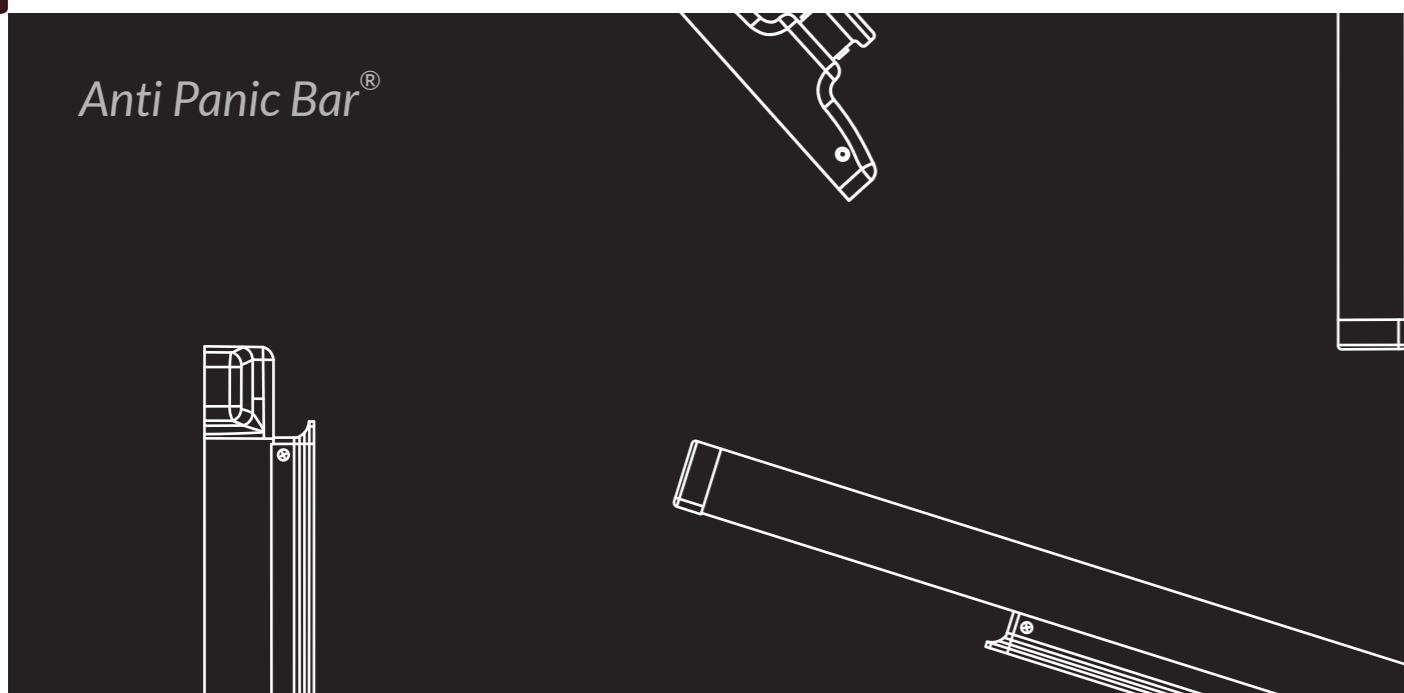

medidas padrão: corpo de barras anti pânico.

standard measurements: body of anti panic bar.

medidas estándar: cuerpo de barra antipánico.

dimensions standard: corps de barre anti-panique.



Z800® Z800R®



*Escritórios, escolas, hospitais, edifícios comerciais, bancos e outras instituições
Offices, schools, hospitals, commercial buildings, banks and other institutions
Oficinas, escuelas, hospitales, edificios comerciales, bancos y otras instituciones
Bureaux, écoles, hôpitaux, bâtiments commerciaux, banques et autres institutions*

en. A série Z800/Z800R (RIM) oferece durabilidade superior para aplicações de alto impacto. São projetados para instalação nova ou adaptada em dispositivos de outros fabricantes. Z800RIM, aplica-se para todos os tipos de portas simples e duplas.

es. La serie Z800/Z800R (RIM) proporciona una durabilidad superior para aplicaciones de alto impacto. Están diseñados para instalación nueva o modernizada en dispositivos de otros fabricantes. Z800RIM es para todo tipo de puertas simples y dobles con/sin parteluz.

en. The series Z800/Z800R (RIM) provides superior durability for high impact applications. They are designed for new or retrofit installation into other manufactures devices. Z800RIM, is for all types of single and double doors with/without a mullion.

fr. La série Z800/Z800R (RIM) offre une durabilité supérieure pour les applications à fort impact. Ils sont conçus pour une installation neuve ou en rénovation dans des appareils d'autres fabricants. Z800RIM, est pour tous les types de portes simples et doubles avec/sans meneau.



Z800V®



pt. Dispositivos de haste vertical. Para todos os tipos de portas simples.

en. Surface Vertical Rod Devices. For all types of single doors.

es. Dispositivos de varilla vertical. Todo tipo de puertas simples.

fr. Dispositifs à tige verticale. Pour tous les types de portes simples.



Z800A®



pt. Travamento de 3 pontos. Para todos os tipos de portas simples e duplas com/sem batente.

en. 3-Point Latching. For all types of single and double doors.

es. Enganche 3 puntos. Todo tipo de puertas simples o dobles.

fr. Verrouillage 3 points. Pour tous types de portes simples et doubles.



Z800M®



pt. Fechadura de encaixe. Para todos os tipos de portas simples ou duplas.

en. Mortise Lock. For all types of single or double doors with/without mullion.

es. Cerradura de embutir. Para todo tipo de puertas simples o dobles con o sin parteluz.

fr. Serrure à mortaise. Pour tous types de portes simples ou doubles avec/sans meneau.



Z800B®



pt. 3-Ponto. Para todos os tipos de portas simples e duplas.

en. 3-Point. For all types of single and double doors with/without mullion.

es. 3 puntos. Todo tipo de puertas simples o dobles con/sin parteluz.

fr. 3 points. Pour tous les types de portes simples et doubles avec/sans meneau.



iBAP01®

pt. Estilo americano, UL. Para todo o tipo de portas simples ou duplas.

en. American style, UL Listed. For all type of single or double doors.

es. Estilo americano, UL. Para todo tipo de puertas simples o dobles.

fr. .Style américain, UL. Pour tout type de portes simples ou doubles.

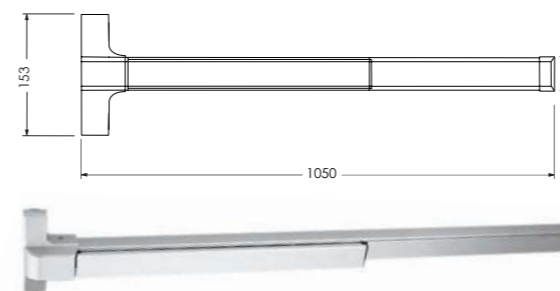

iBAP02®

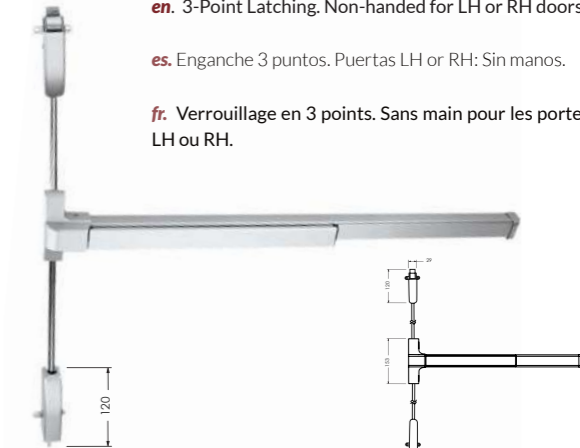

pt. Trava de 3 pontos. Não manual p/ portas LH ou RH.

en. 3-Point Latching. Non-handed for LH or RH doors.

es. Enganche 3 puntos. Puertas LH or RH: Sin manos.

fr. Verrouillage en 3 points. Sans main pour les portes LH ou RH.



iBAP Euro 01®



iBAP Euro 02®



Trinco | Latch | Pestillo | Loquet

Fechadura Elétrica | Electric Lock | Cerradura Eléctrica | Serrure Électrique



iTSL®



iEM®

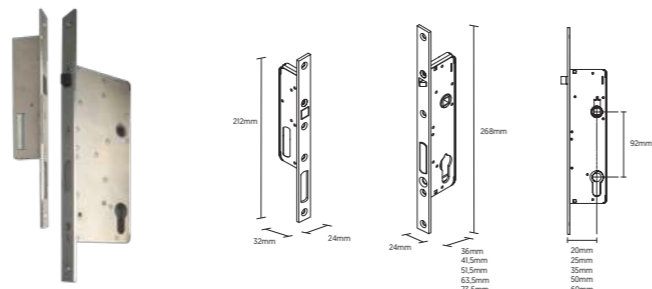
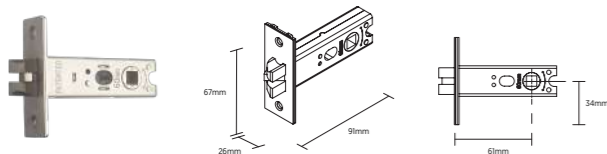

Trinco Eléctrico | Electric Latch | Pestillo Eléctrico | Loquet Électrique

iTEL 01®

iTEL 01® AC/DC 12v iTEL 01-FailSafe® AC/DC 12v iTEL 01-FailSecure® AC/DC 12v iTEL 02® AC/DC 12v



Fechadura Eletromagnética | Electromagnetic Lock | Cerradura Electromagnética | Serrure Électromagnétique

iEM®



	força de retenção retention force fuerza de retención force de rétention	peso weight peso poids
iEM-01-60®	60Kg	0.5Kg
iEM-02-80®	80Kg	0.8Kg
iEM-03-180®	180Kg	1.3Kg
iEM-04-180®	280Kg	2.2Kg
iEM-05-380®	380Kg	2.4Kg
iEM-06-500	500Kg	4.7Kg

Suporte Fechadura Eletromagnética | Support Electromagnetic Lock | Soporte Cerradura Eletromagnética | Support Ferrure Électromagnétique

iSPT®

iSPT-L01® iSPT-Z01® iSPT-G01®

	força de retenção retention force fuerza de retención force de rétention		força de retenção retention force fuerza de retención force de rétention		
iSPT-L01 180®	180Kg	iSPT-Z01 180®	180Kg	iSPT-G01 180®	180Kg
iSPT-L01 280®	280Kg	iSPT-Z01 280®	280Kg	iSPT-G01 280®	280Kg
iSPT-L01 380®	380Kg			iSPT-G01 380®	380Kg
iSPT-L01 600®	600Kg			iSPT-G01 600®	600Kg

Cilindro de Fechadura | Lock Cylinder | Cilindro de la Cerradura | Cylindre de Serrure

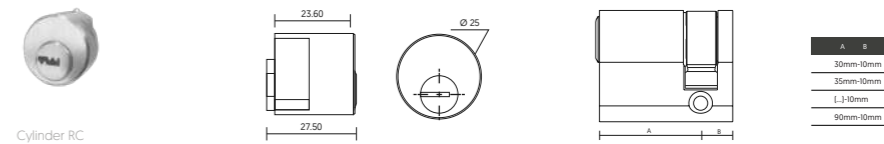
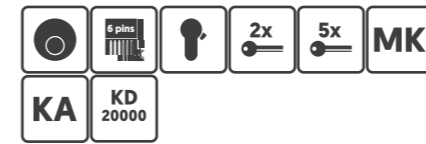
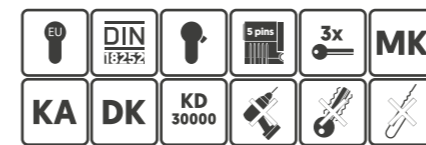
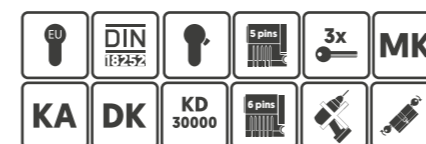

A	B	A	B	A	B
30mm-30mm	45mm- L.]	65mm-30mm	70mm-30mm		
30mm-35mm	45mm-75mm	70mm-30mm	70mm- L.]		
30mm-40mm	50mm-30mm	70mm- L.]	70mm-50mm		
30mm- L.]	50mm- L.]	75mm-30mm	75mm- L.]		
30mm-90mm	50mm-70mm	75mm- L.]	75mm-45mm		
35mm-30mm	55mm-30mm	80mm-30mm	80mm-35mm		
35mm-35mm	55mm- L.]	80mm-35mm	80mm-40mm		
35mm- L.]	55mm-45mm	85mm-30mm	85mm-35mm		
35mm-85mm	60mm-30mm	85mm-35mm	85mm-40mm		
40mm-30mm	60mm- L.]	85mm-40mm	85mm-45mm		
40mm- L.]	60mm-40mm	85mm-45mm	90mm-30mm		
40mm-80mm	65mm-30mm	90mm-30mm			
45mm-30mm	65mm- L.]				

Especificações Técnicas

Technical Specifications | Especificaciones Técnicas | Spécifications Techniques

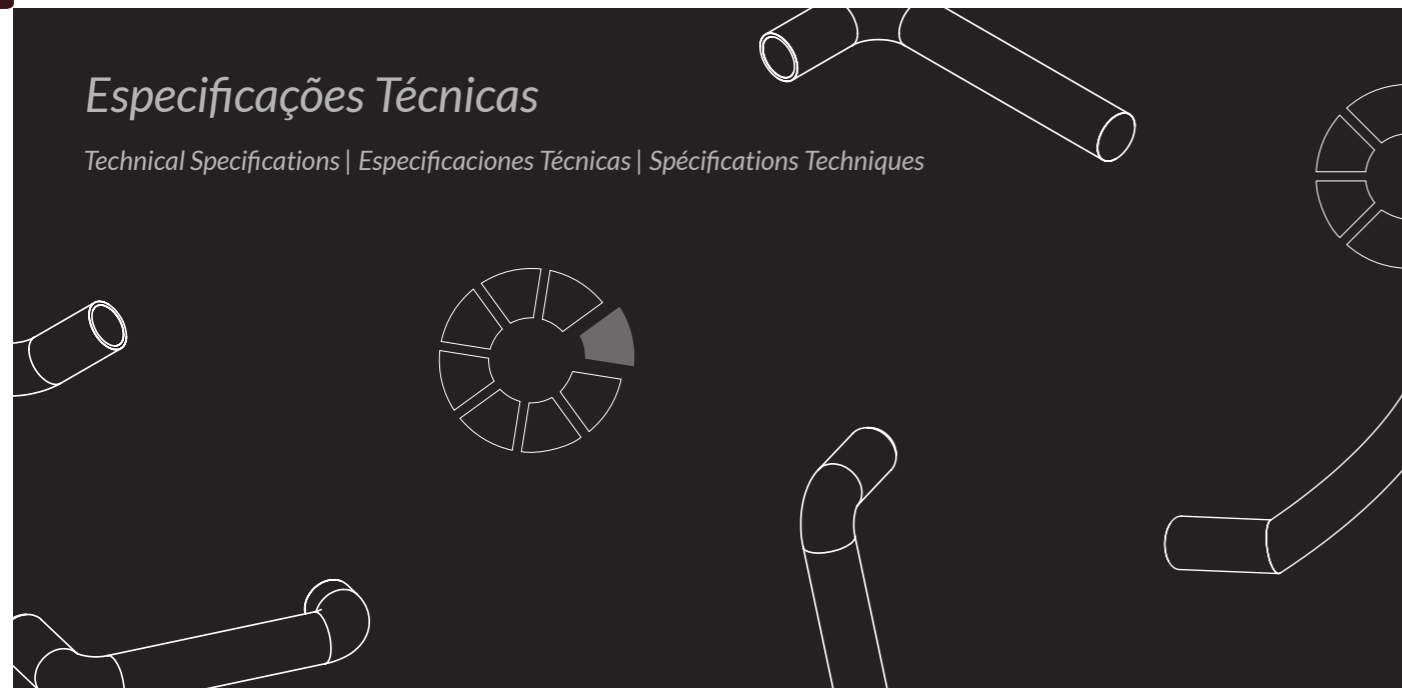

Finishing

Finishing | Acabado | Finition

pt. A AC oferece uma variada gama de acabamentos, de modo a agradar ao estilo pretendido.

en. AC offers a varied range of finishes, so as to please conform to the desired style.

es. La AC ofrece una variada gama de acabados, de forma que se adapte al estilo deseado.

fr. AC propose une gamme variée de finitions, afin de se conformer au style recherché.



LSS

aço inoxidável lacado
lacquered stainless steel
acero inoxidable lacado
acier inoxydable laqué

SSS

aço inoxidável satinado
satin stainless steel
acero inoxidable satin
acier inoxydable satiné

PSS

aço inoxidável latão antigo
polished steel antique brass
inox pulido
inox en laiton vieilli

SSAB

aço inoxidável latão antigo
stainless steel antique brass
acero inoxidable cobre antiguo
inox en laiton vieilli

YPVD

pvd amarelo
yellow pvd
pvd amarillo
pvd jaune



SSBT

aço inoxidável preto titânio
satin steel black titanium
acero inoxidable titanio negro
acier satiné titane noir

SPVD

pvd aço inoxidável
stainless steel pvd
acero inoxidable pvd
acier inoxydable pvd

SSGR

aço inoxidável ouro rosa
stainless steel gold rose
acero inoxidable oro rosa
acier inoxydable rose

Detalhe Material

Detail | Detalle | Détail

pt. Designação: Aço inoxidável DIN 1.4301
Especificações DIN: DIN 1.4301, DIN 2463, DIN 17451
Equidade: AISI 304, UNS S30400

en. Designation: Stainless Steel DIN 1.4301
DIN Specifications: DIN 1.4301, DIN 2463, DIN 17451
Equity: AISI 304, UNS S30400

es. Denominación: Acero Inoxidable DIN 1.4301
Especificaciones DIN: DIN 1.4301, DIN 2463, DIN 17451
Equidad: AISI 304, UNS S30400

fr. Denominación: Acero Inoxidable DIN 1.4301
Especificaciones DIN: DIN 1.4301, DIN 2463, DIN 17451
Equidad: AISI 304, UNS S30400

Acabamento

Finishing | Acabado | Finition

pt. Satinado: Aparência fosca.
A rugosidade varia entre 0,10 e 0,15 microRa.

Brilhante: Acabamento muito fino.
A superfície polida reflete como um espelho.

PVD: Deposição Física de Vapor.
Processo a vácuo, com temperatura entre 150° e 500°C.
Alta resistência mecânica.

Lacado: Processo de pintura com base em poliéster endurecido.
Resistente à corrosão com ampla personalização

en. Satin: Matte appearance.
The roughness varies between 0.10 and 0.15 micro Ra.

Glossy: Very fine finish.
The polished surface reflect like a mirror.

PVD: Physical Vapor Deposition.
Vacuum process, with temperature between 150° and 500°C.
High mechanical resistance.

Lacquered: Painting process with a hardened polyester base. Corrosion resistant with wide customization

es. Satinado: Aspecto mate.
La rugosidad varia entre 0,10 y 0,15 micro Ra.

Brillante: Acabado muy fino.
La superficie pulida se refleja como un espejo.

PVD: Deposition física de vapor.
Proceso al vacío, con temperatura entre 150° y 500°C.
Alta resistencia mecánica.

Lacado: Proceso de pintura con base de poliéster endurecido.
Resistente a la corrosión con amplia personalización.

fr. Satiné : Aspect mat.
La rugosité varie entre 0,10 et 0,15 micro Ra.

Brillant : Finition très fine.
La surface polie reflète comme un miroir.

PVD : dépôt physique en phase vapeur.
Processus sous vide, avec une température comprise entre 150° et 500°C.
Haute résistance mécanique.

Laqué : procédé de peinture à base de polyester durci. Résistant à la corrosion avec une large personnalisation

Puxadores

Handles | Manillas | Poignées

Encomenda

By Order | Por Pedido | Par Demande

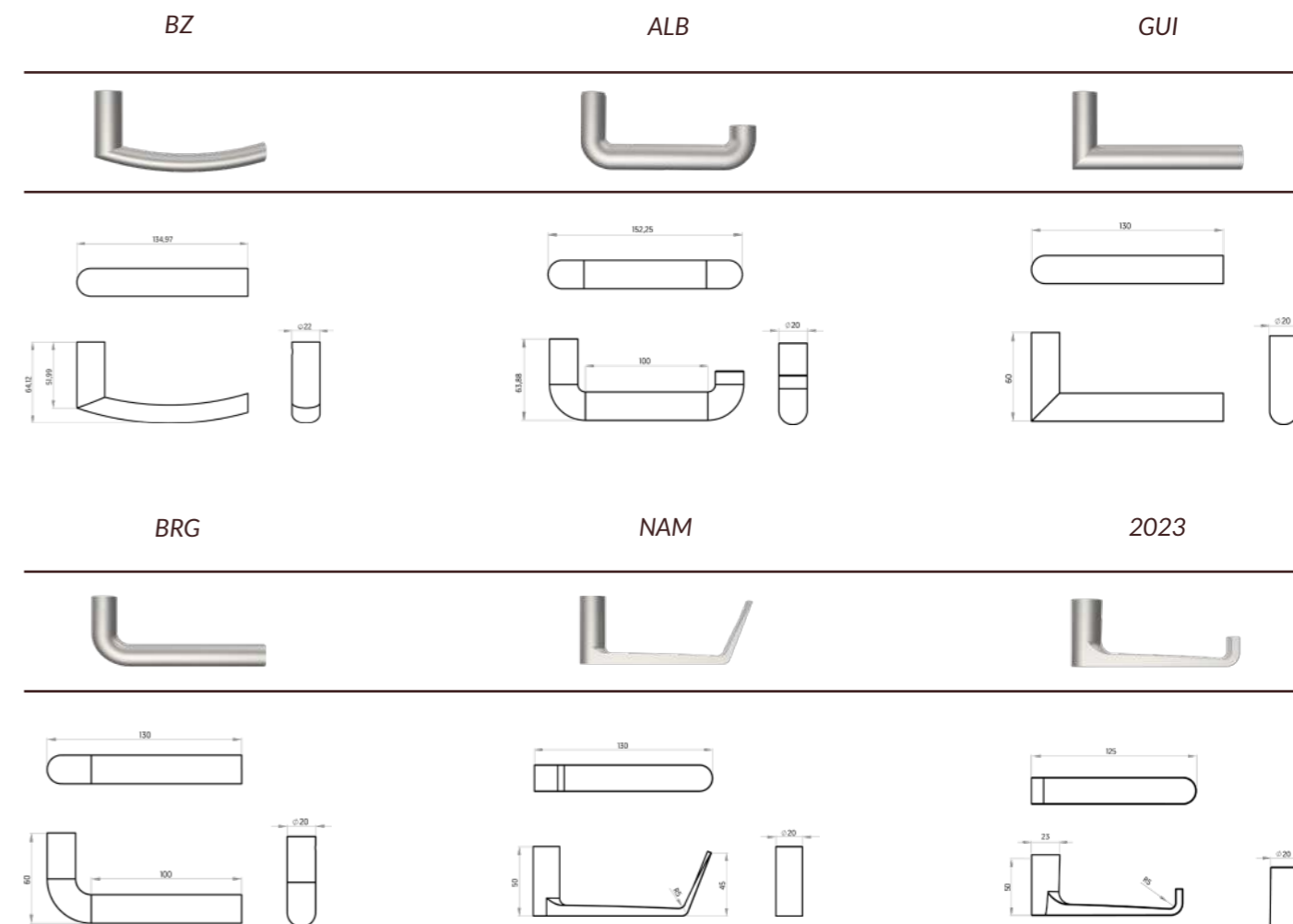

Linha Completa. Barreiras e Torniquetes | Complete Line. Barriers and Turnstiles



TORNIQUETES

iTEC
one step forward

pt. Reconhecimento de íris, facial, impressão digital e máscara. Acesso via bluetooth, app, cartão, sistema wi-fi e IoT, RFID. Reconhecimento via câmara: registo do carro. Via scanner: passaporte.

en. Iris recognition, facial, fingerprint and mask. Access via bluetooth, app, card, wi-fi system and IoT, RFID. Recognition via camera: car registration. Via scanner: passport.

es. Reconocimiento de íris, facial, huella dactilar y máscara. Acceso através de bluetooth, app, tarjeta, wifi y sistema IoT, RFID. Reconocimiento por cámara: matriculación del vehículo. Via escáner: pasaporte.

fr. Reconnaissance de l'iris, facial, empreinte digitale et masque. Accès via bluetooth, app, carte, système wi-fi et IoT, RFID. Reconnaissance par caméra: immatriculation du véhicule. Par scanner: passeport





CATÁLOGO TORNQUETES

Inovação. Segurança. Acesso

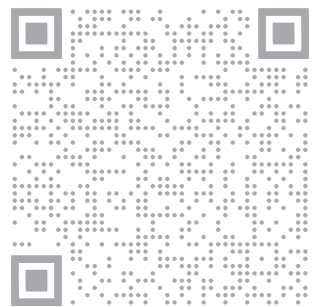

TURNSTILES CATALOG | CATÁLOGO TORNQUETES | CATALOGUE TOURNIQUETS

Innovation. Safety. Access
 Innovación. Seguridad. Acceso
 Innovation. Sécurité. Accès

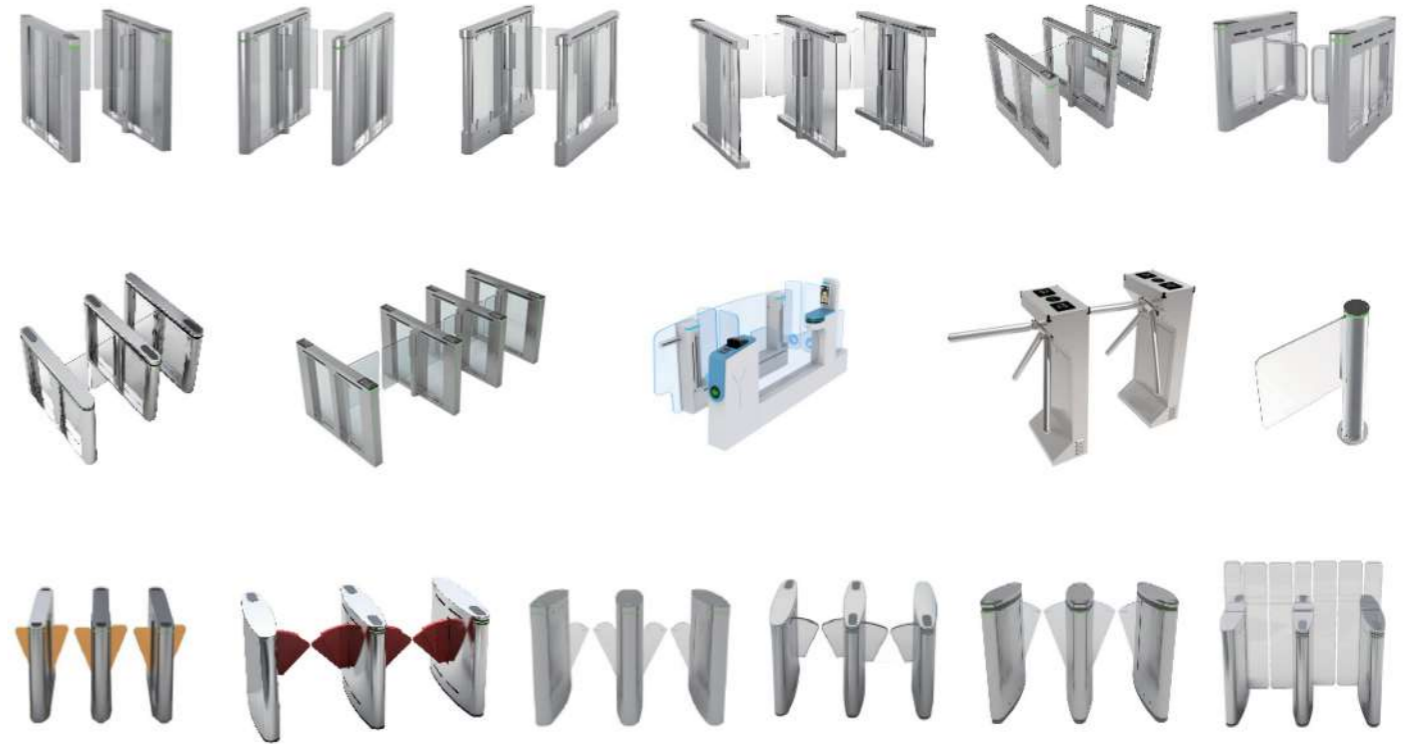

Contacts

Contactos

iTEC Portugal

Edifício FeiraPark, Rua do Feira Park, nº50
4520-632 São João de Ver
Portugal

Tel.: +351 256 307 078
email.: info@itec.com.pt
www.itec.com.pt

WHERE WHEN WHO● WHERE WHEN WHO● WHERE
WH● WHERE WHEN WHO● WHERE WHEN WHO●
WHEN WHO● WHERE WHEN WHO● WHERE WHEN
WHERE WHEN WHO● WHERE WHEN WHO● WHERE
WH● WHERE WHEN WHO● WHERE WHEN WHO●