



PTZ Network Camera User Manual

Version: V3.0
Date: 2022-01-18

Chapter 1. Introduction.....	4
1.1 Copyright Statement.....	4
1.2 Industry Canada ICES-003 Compliance.....	4
1.3 Safety Instruction.....	4
1.4 EU Conformity Statement.....	5
Chapter 2. Product Description.....	6
2.1 Product Overview.....	6
2.2 Key Features.....	6
2.3 Hardware Overview.....	7
23X/30X/36X/42X Speed Dome Network Camera.....	7
AI 23X/30X/36X/42X Speed Dome Network Camera.....	9
(AI) 12X Mini PTZ Bullet Network Camera.....	10
AI 5X/20X/23X Mini PTZ Bullet Plus Network Camera.....	13
(AI) 12X/20X/23X Mini PTZ Dome Network Camera.....	14
2.4 How to Connect to Alarm Interface.....	15
2.5 How to Connect the Water-proof Connector.....	15
2.6 System Requirements.....	16
Chapter 3. Network Connection.....	17
3.1 Setting the Camera over the LAN.....	17
3.1.1 Connect the Camera to the PC Directly.....	17
3.1.2 Connect via a Switch or a Router.....	17
3.2 Dynamic IP Connection.....	18
Chapter 4. Accessing the Network Camera.....	19
4.1 Assigning An IP Address.....	19
4.1.1 Assigning An IP Address Using Smart Tools.....	19
4.1.2 Assign An IP Address via Browser.....	24
4.2 Accessing from the Web Browser.....	26
4.2.1 Access with Plugin.....	27
4.2.2 Access without Plugin.....	29
4.3 Accessing from Milesight VMS (Video Management Software).....	30
Chapter 5. System Operation Guide.....	32
5.1 Live Video.....	32

5.1.1 Operations on Live View Page.....	32
5.1.2 3D Positioning.....	36
5.1.3 Set / Call a Preset / Patrol / Pattern.....	36
5.2 Playback.....	41
5.3 Local Settings.....	44
5.4 Basic Settings.....	44
5.4.1 Video.....	44
5.4.2 Image.....	47
5.4.3 Audio.....	58
5.4.4 Network.....	60
5.4.5 Date&Time.....	77
5.5 Advanced Settings.....	78
5.5.1 Storage.....	78
5.5.2 Security.....	83
5.5.3 SIP.....	89
5.5.4 PTZ.....	92
Logs.....	102
5.6 Event.....	104
5.6.1 Basic Event.....	104
5.6.2 VCA Event.....	118
5.6.3 People Counting.....	140
5.6.4 Face Detection (Optional).....	152
5.7 LPR (Optional).....	160
5.7.1 Live Video.....	160
5.7.2 Settings.....	161
5.7.3 Smart Search.....	181
5.8 System.....	183
5.9 Maintenance.....	185
5.9.1 System Maintenance.....	185
5.9.2 Auto Reboot.....	189
Chapter 6. Services.....	190

Chapter 1. Introduction

Thank you for purchasing our product. If there is any questions or requests, please do not hesitate to contact your dealer.

This Manual explains how to use and manage Milesight network cameras on your network. Previous experience of networking will be of use when using the products. Please read this manual carefully before operation and retain it for future reference.

This manual may contain several technically incorrect places or printing errors, and the content is subject to change without notice. The updates will be added into the new version of this manual. We will readily improve or update the products or procedures described in the manual.

1.1 Copyright Statement

This manual may not be reproduced in any form or by any means to create any derivative such as translation, transformation, or adaptation without the prior written permission of Milesight Technology Co., Ltd (Hereinafter referred to as Milesight).

Milesight reserves the right to change this manual and the specifications without prior notice. The latest specifications and user documentation for all Milesight products are available on our official website www.milesight.com

1.2 Industry Canada ICES-003 Compliance

This Class B digital apparatus complies with Canadian ICES-003.

Cet appareil numérique de la classe B est conforme à la norme NMB-003 du Canada.

1.3 Safety Instruction

These instructions are intended to ensure that user can use the product correctly to avoid danger or property loss. The precaution measures are divided into “Warnings” and “Cautions”

Warnings: Serious injury or death may be caused if any of these warnings is neglected.

- This installation must be conducted by a qualified service person and should strictly comply with the electrical safety regulations of the local region

- To avoid risk of fire and electric shock, do keep the product away from rain and moisture before installed.
- Do not touch components such as heat sinks, power regulators, and processors, which may be hot
- Source with DC/AC 12V or PoE
- Please make sure the plug is firmly inserted into the power socket
- When the product is installed on a wall or ceiling, the device should be firmly fixed
- If the product does not work properly, please contact your dealer. Never attempt to disassemble the camera by yourself

Cautions: Injury or equipment damage may be caused if any of these cautions are neglected.

- Make sure that the power supply voltage is correct before using the camera
- Do not store or install the device in extremely hot or cold temperatures, dusty or damp locations, and do not expose it to high electromagnetic radiation
- Only use components and parts recommended by manufacturer
- Do not drop the camera or subject it to physical shock
- To prevent heat accumulation, do not block air circulation around the camera
- Laser beams may damage image sensors. The surface of image sensors should not be exposed to where a laser beam equipment is used
- Use a blower to remove dust from the lens cover
- Use a soft, dry cloth to clean the surface of the camera. Stubborn stains can be removed using a soft cloth dampened with a small quantity of detergent solution, then wipe dry
- Do not use volatile solvents such as alcohol, benzene or thinners as they may damage the surface finishes
- Save the package to ensure availability of shipping containers for future transportation

1.4 EU Conformity Statement

2012/19/EU (WEEE directive): Products marked with this symbol cannot be disposed of as unsorted municipal waste in the European Union. For proper recycling, return this product to your local supplier upon the purchase of equivalent new equipment, or dispose of it at designated collection points. For more information see: www.recyclethis.info.

2006/66/EC (battery directive): This product contains a battery that cannot be disposed of as unsorted municipal waste in the European Union. See the product documentation for specific battery information. The battery is marked with this symbol, which may include lettering to indicate cadmium (Cd), lead (Pb), or mercury(Hg). For proper recycling, return the battery to your supplier or to a designated collection point. For more information see: www.recyclethis.info.

Chapter 2. Product Description

2.1 Product Overview

Milesight provides a consistent range of cost-effective and reliable network cameras to fully meet your requirements. Based on embedded Linux operating system, Milesight network cameras could be easily accessed and managed either locally or remotely with great reliability. With built-in high-performance DSP video processing modules, the cameras pride on low power consumption and high stability. They support state-of-the-art H.265/ H.264/ MJPEG video compression algorithm and industry-leading HD dual-stream technology to achieve the highest level of video image quality under the limited network resources. It is fully functional, supporting for flexible and comprehensive alarm linkage mechanism, day and night auto switch and privacy masking, etc.

In practical applications, Milesight network cameras could either work independently in the LAN, or be networked to form a powerful safety monitoring system. It is widely used in fields such as finance, education, industrial production, civil defense, health care for security's sake.

2.2 Key Features

- Up to 30X Optical Zoom for Speed Dome, 42X for Speed Dome II, 23X Optical Zoom for Mini PTZ Bullet and 23X for Mini PTZ Dome
- 360° continuous pan and 0°~ 90° (Auto Flip) tilt for Speed Dome/ Speed Dome II
- 360° continuous pan and -45°~30° tilt for Mini PTZ Bullet
- 360° continuous pan and -5°~90° (Auto Flip) tilt for Mini PTZ Dome
- 300 Preset Points, 8 Patrols and 4 Patterns
- Based on Linux OS with high reliability
- H.265/ H.264/ MJPEG video compression capability
- Support AI Video Analytics
- Support Plugin-Free mode
- Support Smart Stream
- Support ONVIF Profile G & Q & S & T
- Support activation and set-up of the security questions for cameras(V4x.7.0.69 or above)
- ICR filter with auto switch, true day/night
- Built-in WEB server, support IE/ Firefox/ Chrome/ Safari browser
- UPnP protocol for the easy management of IPC
- Support Milesight DDNS
- Auto Tracking, 3D Positioning, PTZ Motion, PTZ Limit, Scheduled Tasks and Auto Home function
- White LED for Mini PTZ Bullet
- Motion Detection, Privacy Masking, Network Fault Detection and ROI

- FTP upload, SMTP upload, SD card record and SIP function
- G.711/AAC audio compression capability
- Audio Input/Output and Alarm Input/Output
- Three-privilege levels of users for flexible management
- Micro SD/SDHC/SDXC card local storage support, expand the edge storage
- Local PAL/NTSC signal output

2.3 Hardware Overview

23X/30X/36X/42X Speed Dome Network Camera

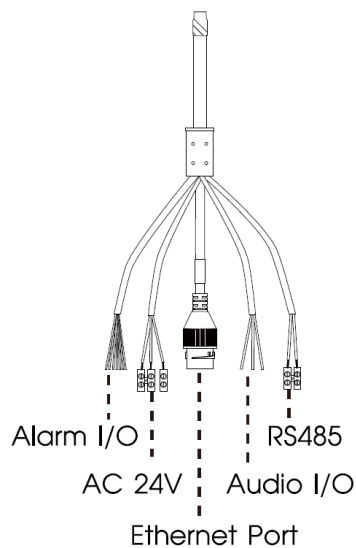
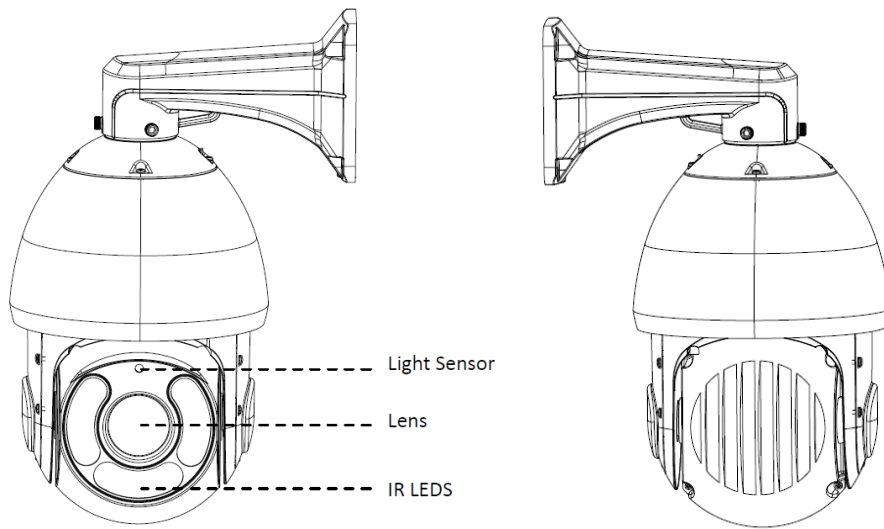

 **Note:**

- Only AC 24V is available for Speed Dome power supply. AC 24V and PoE (802.3at) are available for PoE Speed Dome power supply.
- Reset Button: Press “Reset” button for 5 seconds, then the device will be restored to factory default.

AI 23X/30X/36X/42X Speed Dome Network Camera

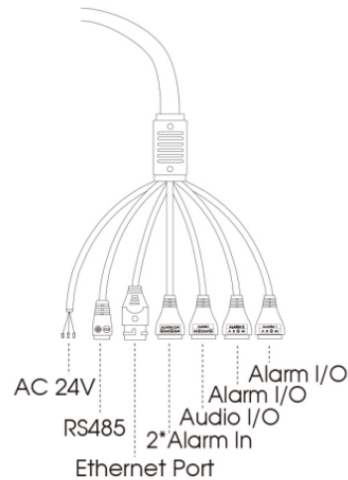
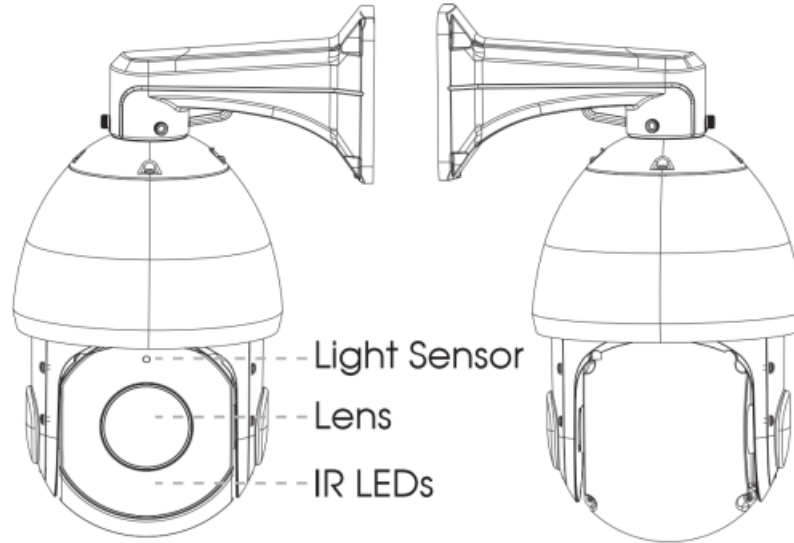

Note:

- Only AC 24V is available for AI Speed Dome power supply. AC 24V and PoE (802.3at) are available for PoE AI Speed Dome power supply.
- Reset Button: Press “Reset” button for 5 seconds, then the device will be restored to factory default.

(AI) 12X Mini PTZ Bullet Network Camera

Wall Mount:

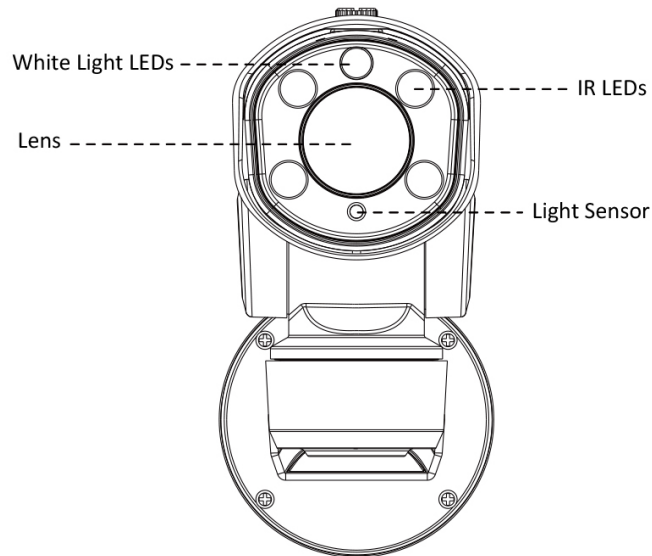

Pedestal Mount (Only for non-AI Mini PTZ Bullet) :

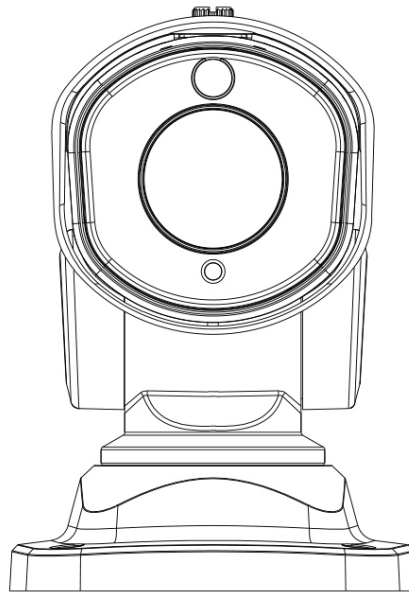

Mini PTZ Bullet (Only for non-AI PTZ bullet) :

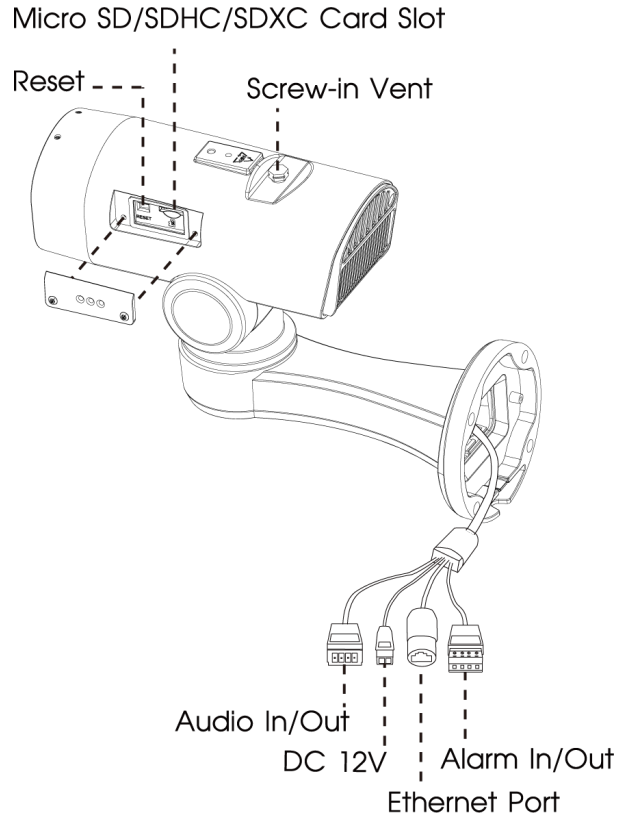

(AI) Mini PoE PTZ Bullet:

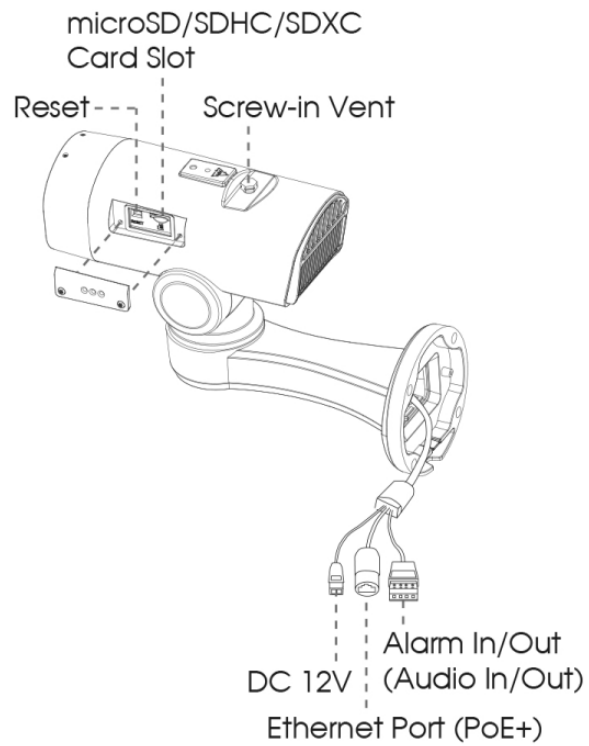

 **Note:**

- **Reset Button:** Press “Reset” button for 5 seconds, then the device will be restored to factory default.
- Only DC 12V is available for Mini PTZ Bullet power supply. DC 12V and PoE (802.3at) are available for (AI) Mini PoE PTZ Bullet power supply.

AI 5X/20X/23X Mini PTZ Bullet Plus Network Camera

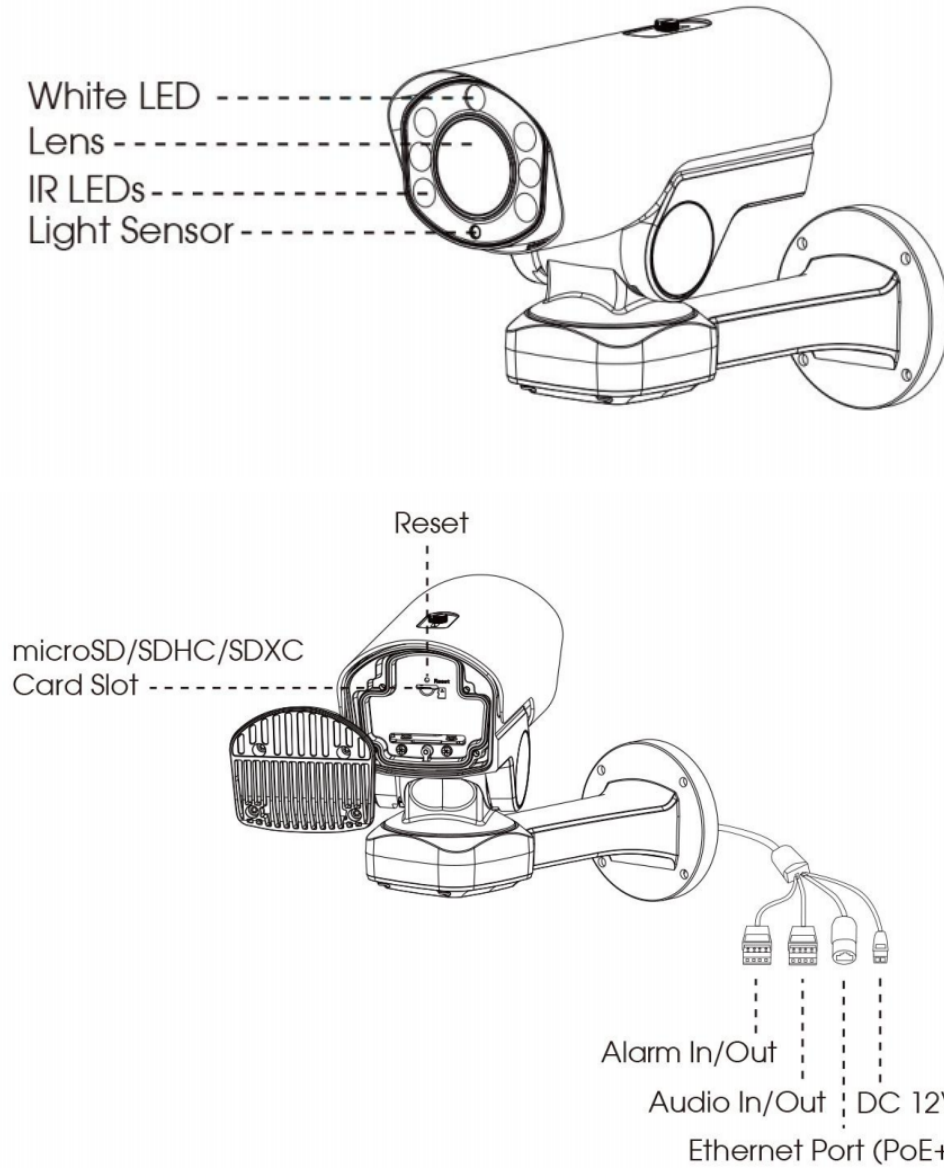

Note:

- Reset Button: Press “Reset” button for 5 seconds, then the device will be restored to factory default.
- DC 12V and PoE (802.3at) are available for power supply.

(AI) 12X/20X/23X Mini PTZ Dome Network Camera

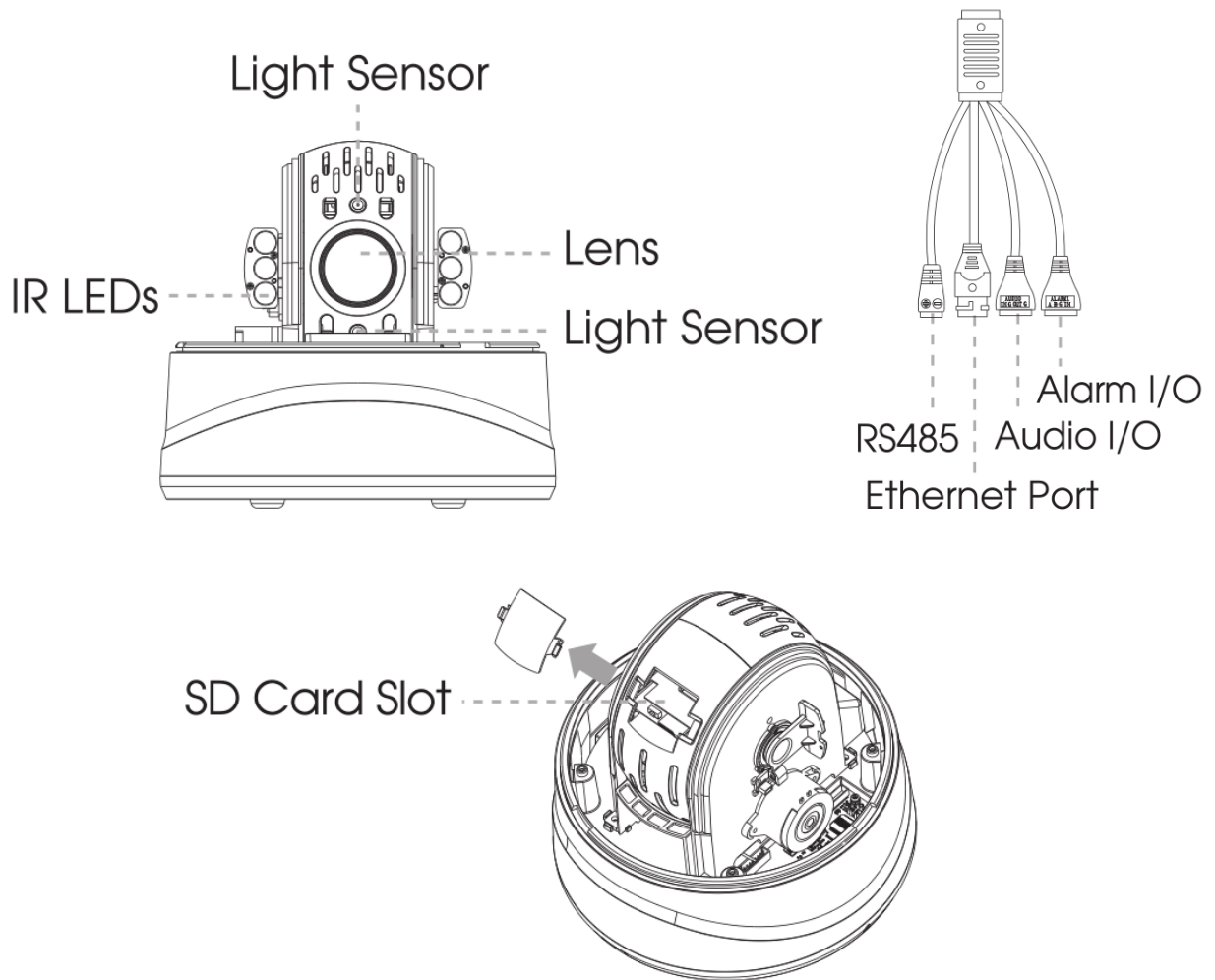

 **Note:**

- Reset Button: Press “Reset” button for 5 seconds, then the device will be restored to factory default.
- DC 12V and PoE (802.3at) are available for power supply.

2.4 How to Connect to Alarm Interface

External interface of camera is as the following, you can refer to the picture to install the external alarm device:

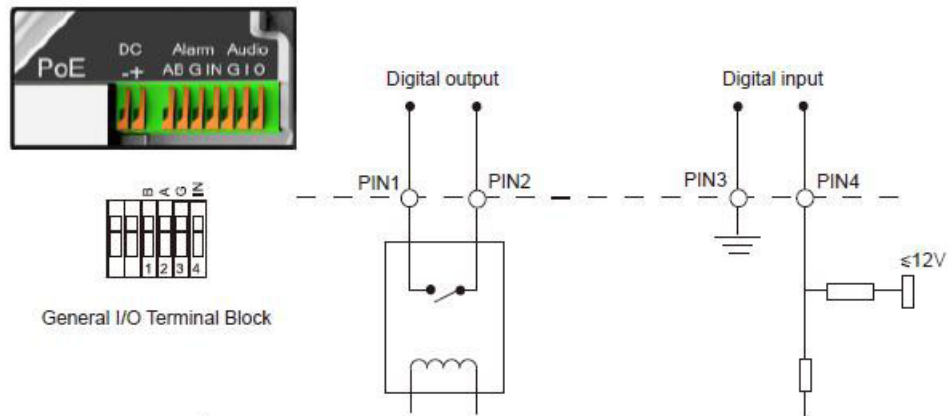

- PIN1: Alarm Output NC/NO 24V DC 1A
- PIN2: Alarm Output NC/NO 24V DC 1A
- PIN3: Alarm Input NC/NO $\leq 12V$
- PIN4: Alarm Input NC/NO $\leq 12V$

2.5 How to Connect the Water-proof Connector

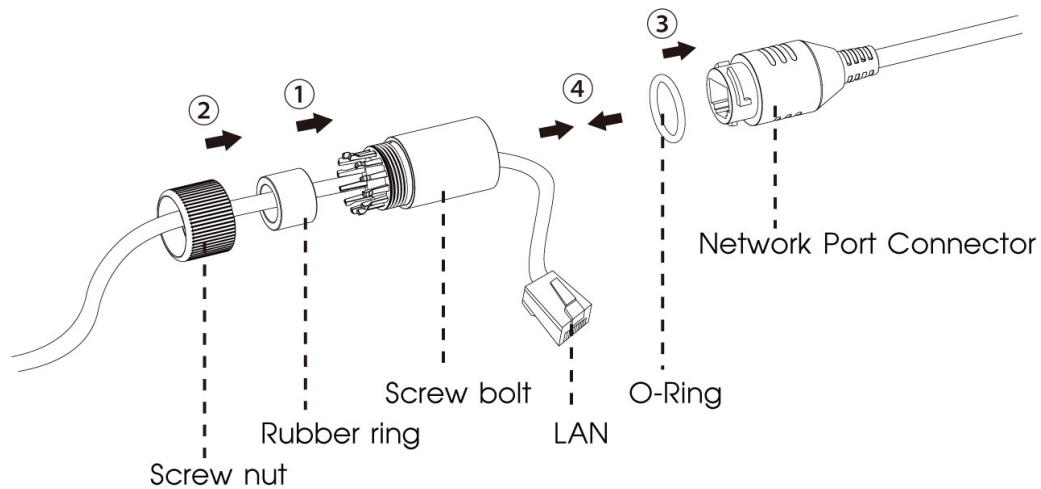

Step1: Get the network cable through the screw nut, rubber ring and the screw bolt.

Step2: Insert the rubber ring into the screw bolt.

Step3: Connect the screw nut to the screw bolt.

Step4: Place the O-Ring on the network port connector.

Step5: Connect the RJ45 to the network port connector, and tighten the screw bolt and the connector.

2.6 System Requirements

Operating System: Windows XP/Vista/7/8/10/Server 2000/Server 2008

CPU: 1.66GHz or higher

RAM: 1G or higher

Graphic memory: 128MB or more

Internet protocol: TCP/IP (IPv4/IPv6)

Web Browsers: Internet Explorer 8.0 and above version, Mozilla Firefox, Google Chrome and Safari.

Chapter 3. Network Connection

3.1 Setting the Camera over the LAN

Connecting the camera to a switch or a router is the most common connection method. The camera must be assigned an IP address that is compatible with its LAN.

3.1.1 Connect the Camera to the PC Directly

In this method, only the computer connected to the camera will be able to view the camera. The camera must be assigned a compatible IP address to the computer. Details are shown as the following figure.

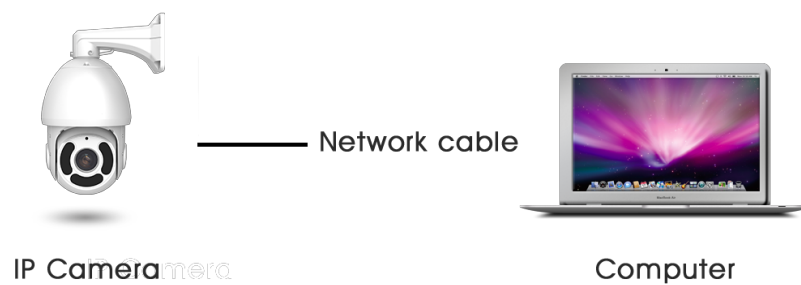

3.1.2 Connect via a Switch or a Router

Refer to the following figure to set network camera over the LAN via the switch or router.



3.2 Dynamic IP Connection

Connecting the network camera via a router

Step1: Connect the network camera to a router;

Step2: On the camera, assign a LAN IP address, the Subnet mask and the Gateway;

Step3: On the router, set port forwarding. E.g. 80, 8000 and 554 ports. The steps for port forwarding vary depending on different routers. Please look up the router's user manual for assistance with port forwarding;

Step4: Apply a domain name from a domain name provider;

Step5: Configure the DDNS settings in the setting interface of the router;

Step6: Visit the camera via the domain name.

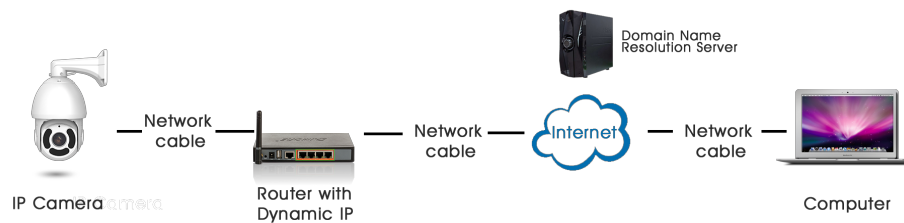

Chapter 4. Accessing the Network Camera

The camera must be assigned an IP address to be accessible.

4.1 Assigning An IP Address

The Network Camera must be assigned an IP address to be accessible. The default IP address of Milesight network cameras is 192.168.5.190.

You can either change the IP address of the camera via Smart Tools or browser. Please connect the camera in the same LAN of your computer.

4.1.1 Assigning An IP Address Using Smart Tools

Smart Tools is a software tool which can automatically detect multiple online Milesight network cameras in the LAN, set IP addresses, and manage firmware upgrades. It's recommended to use when assigning IP addresses for multiple cameras.

Step1: Install Smart Tools (The software could be downloaded from our website);

Step2: Start Smart Tools, click the IPC Tools page, then enter the device information, such as IP address, MAC address, Status, Port number, Netmask, and Gateway, then all related Milesight network cameras in the same network that will be displayed. Details are shown as the figure below;

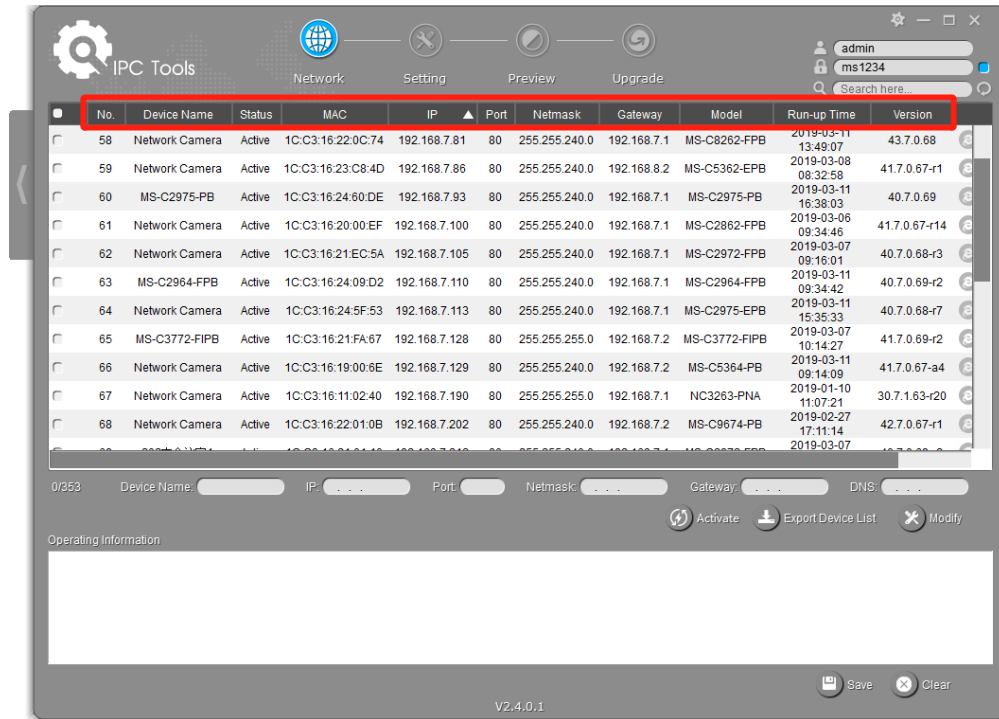

Step3: Select a camera or multiple cameras according to the MAC addresses;

Select single camera:

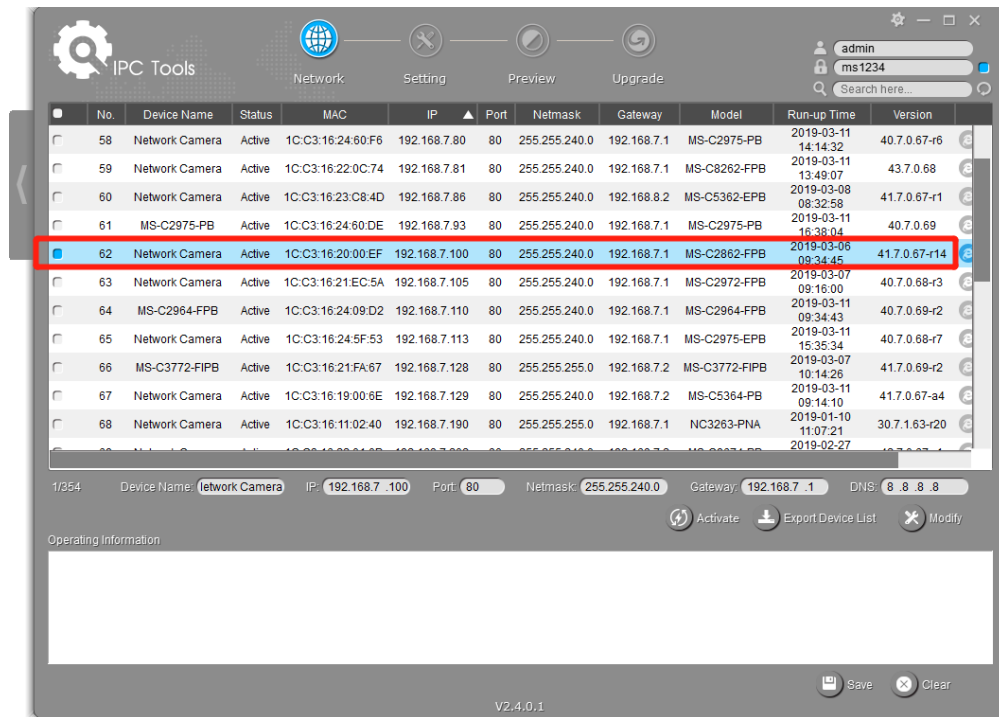

Select multiple cameras:

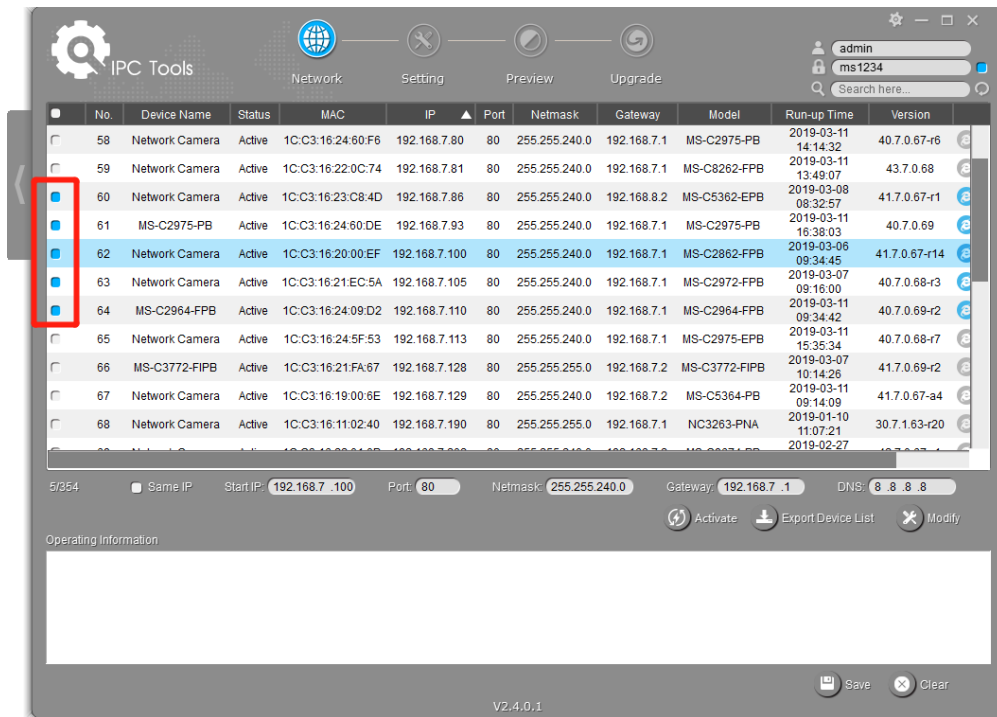

Step4: If the selected camera shows "Active" in the status bar, you can directly type the User Name and Password (Camera with version lower than 4x.7.0.69 is using admin/ms1234 by default), change the IP address or other network values, and then click “Modify” button;

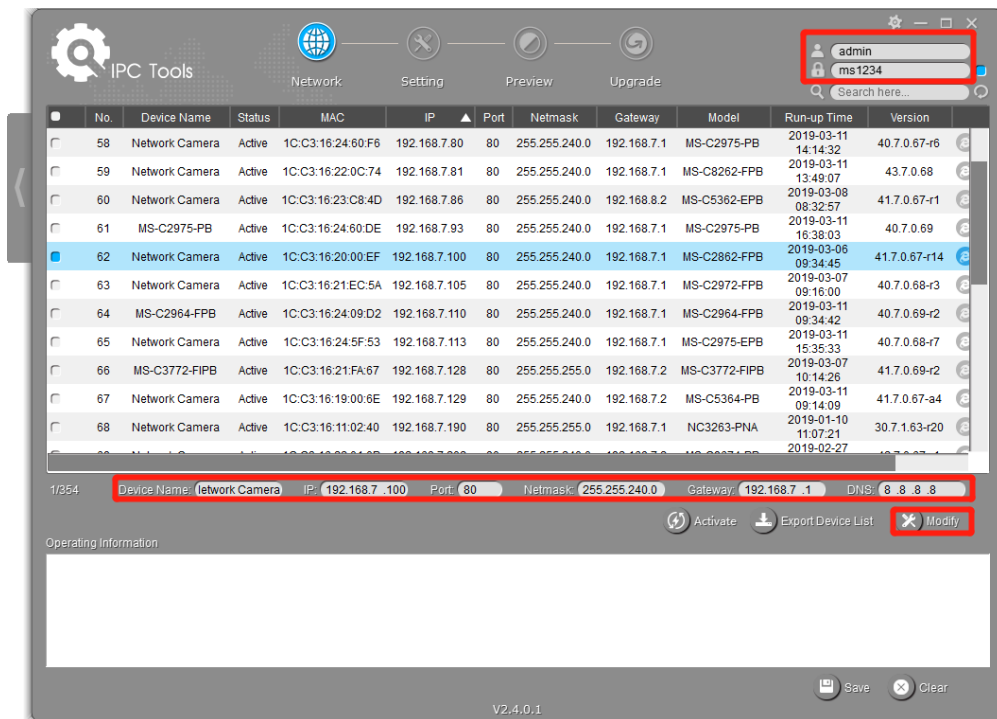

If the selected camera shows "Inactive" in the status bar (Camera with version V4x.7.0.69 or

above), click  to set the password when using it for the first time. You can also set the security questions when activating the camera in case that you forget the password (You can reset the password by answering three security questions correctly). Click 'Save' and it will show that the activation was successful.

 **Note:**

- Password must be 8 to 32 characters long, contain at least one number and one letter.
- You need to upgrade Smart Tools version to V2.4.0.1 or above to activate the camera.

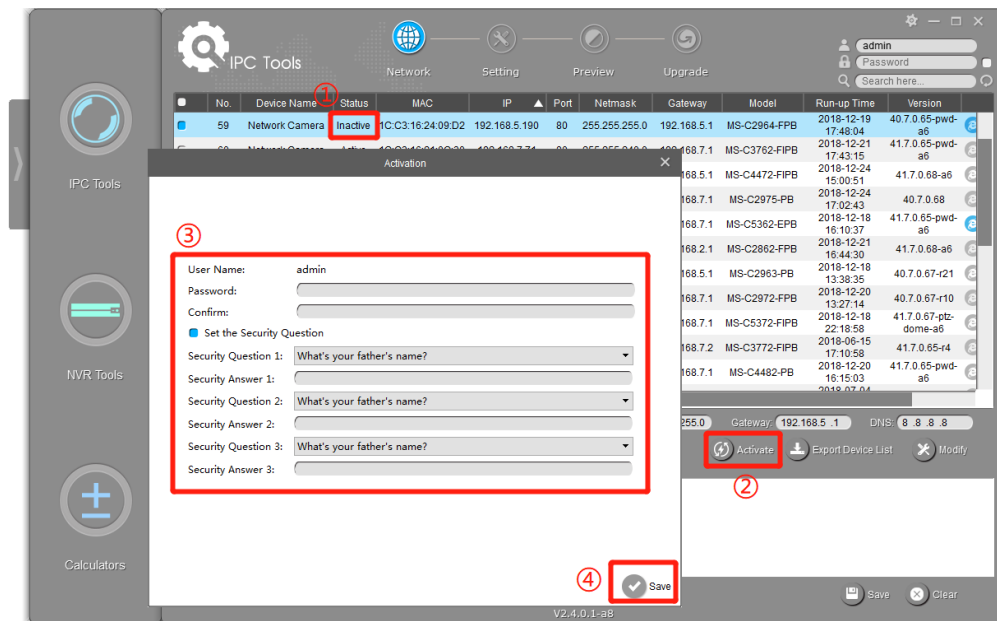

After activation, you can change the IP address or other network values, and then click "Modify" button.

The screenshot shows the 'IPC Tools' software interface. At the top, there are navigation icons for Network, Setting, Preview, and Upgrade. A user profile for 'admin' with ID '12345678' is visible in the top right. The main area contains a table of network devices:

No.	Device Name	Status	MAC	IP	Port	Netmask	Gateway	Model	Run-up Time	Version
58	Network Camera	Active	1C:C3:16:90:81:5E	192.168.7.92	80	255.255.240.0	192.168.7.1	NC9674-PB	2019-09-24 17:36:18	43.7.1.72
59	Network Camera	Active	1C:C3:16:20:00:EF	192.168.7.100	80	255.255.240.0	192.168.7.1	MS-C2962-FPB	2019-09-23 14:06:52	41.7.0.72-a5
60	Network Camera	Active	1C:C3:16:21:00:22	192.168.7.104	80	255.255.240.0	192.168.7.1	MS-C2962-FIPB	2019-09-02 03:22:14	40.7.0.69-r11
61	Network Camera	Active	1C:C3:16:24:09:...	192.168.7.114	80	255.255.240.0	192.168.7.1	MS-C2964-FPB	2019-09-30 08:55:39	40.7.0.72
62	Network Camera	Active	1C:C3:16:23:01:39	192.168.7.124	80	255.255.240.0	192.168.9.2	MS-C2962-FPB	2019-09-26 08:28:26	41.7.0.71-r35
63	IPCAM	Active	1C:C3:16:21:FA:67	192.168.7.132	80	255.255.255.0	192.168.5.1	MS-C3772-FIPB	2019-09-27 11:25:49	41.7.0.71-r15
64	Network Camera	Active	1C:C3:16:24:66:A1	192.168.7.161	80	255.255.240.0	192.168.5.1	MS-C2962-FPB	2019-09-26 09:46:16	40.7.0.71-r8
65	Network Camera	Active	1C:C3:16:22:19:6F	192.168.7.201	80	255.255.240.0	192.168.7.1	MS-C9674-PB	2019-09-17 11:20:43	43.7.0.72-fsh-autotrack-a2
66	Network Camera	Active	1C:C3:16:22:01:0B	192.168.7.202	4200	255.255.240.0	192.168.7.2	MS-C9674-PB	2019-07-31 23:53:33	42.7.0.67-r1
67	202大会议室1	Active	1C:C3:16:21:01:10	192.168.7.212	80	255.255.240.0	192.168.7.1	MS-C2972-FPB	2019-09-25 14:19:04	40.7.0.71-r15
68	202大会议室2	Active	1C:C3:16:21:32:...	192.168.7.214	80	255.255.240.0	192.168.7.1	MS-C2972-FPB	2019-09-26	40.7.0.71-r16

Below the table, the selected device (No. 61) is shown with details: Device Name: Network Camera, IP: 192.168.7.114, Port: 80, Netmask: 255.255.240.0, Gateway: 192.168.7.1, DNS: 8.8.8.8. There are buttons for 'Activate', 'Export Device List', and 'Modify'. The 'Operating Information' section shows a log entry: '1 2019-09-30 09:10:53 [1C:C3:16:24:09:D2] Modify IP:192.168.7.113->192.168.7.114 successfully.' The interface also includes 'Save' and 'Clear' buttons and a version number 'V2.4.0.1-r6'.

Step6: By double clicking the selected camera or the browser of interested camera, you can access the camera via web browser directly. The Internet Explorer window will pop up.

The screenshot shows the Milesight login page. At the top right, there is a language dropdown menu set to 'English'. The main content area features the Milesight logo and a login form with the following elements:

- User Name input field
- Password input field
- Remember me? checkbox
- Forgot Password? link
- Login button
- User icon

At the bottom of the page, there is a link for 'Download Plugin for Network Camera' and a copyright notice: 'Copyright © Milesight All rights reserved.'

More usage of Smart Tools, please refer to the *Smart Tools User Manual*.

4.1.2 Assign An IP Address via Browser

If the network segment of the computer and that of the camera are different, please follow the steps to change the IP address:

Step1: Change the IP address of computer to 192.168.5.0 segment, here are two ways as below:

a. Start→Control Panel→Network and Internet Connection→Network Connection→Local Area Connection, and double click it;

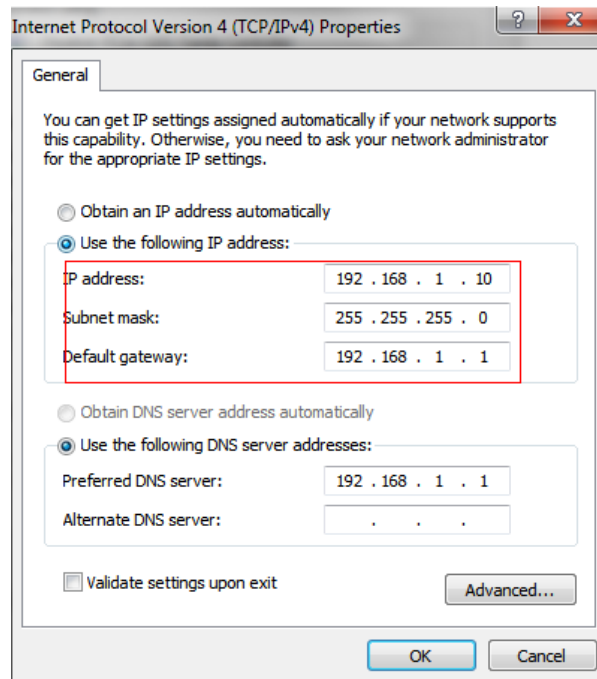

b. Click “Advanced”, and then click “IP settings”# “IP address”# “Add”. In the pop-up window, enter an IP address that in the same segment with Milesight network cameras (e.g. 192.168.5.61, but please note that this IP address shall not conflict with the IP address on the existing network);

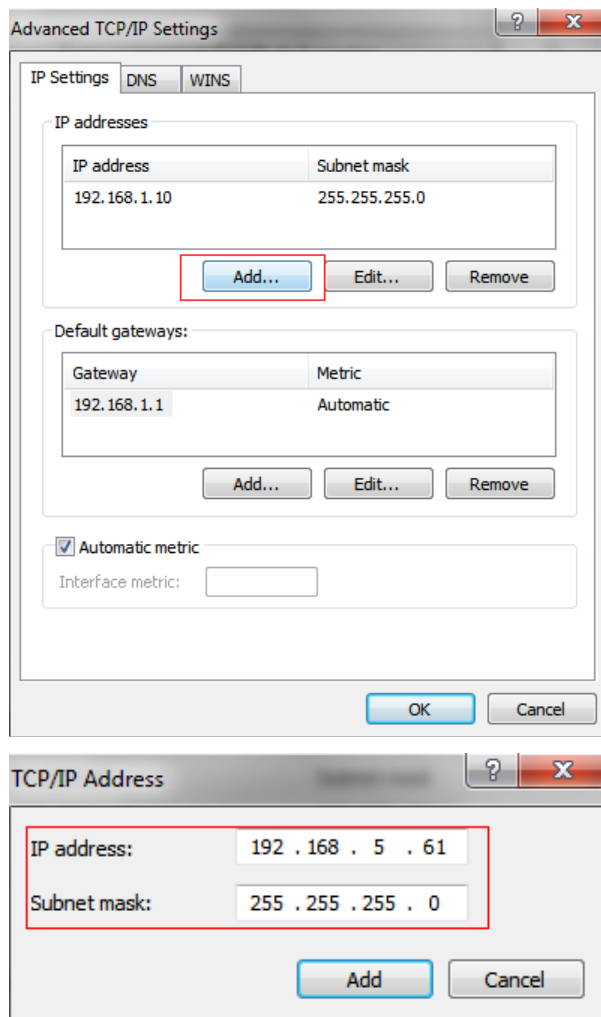

Step2: Start the browser. In the address bar, enter the default IP address of the camera:<http://192.168.5.190>;

Step3: If the camera's firmware version is lower than V4x.7.0.69, it will directly display the login page, enter the user name and password when the LOGIN page appears;

- Default user name: admin
- Default password: ms1234



If the camera's firmware version is V4x.7.0.69 or above, you need to set the password first when using it for the first time. And you can also set three security questions for your device after activation. Then, you can log in the device with You can log in to the camera with the username(admin) and a custom password.

Note:

- Password must be 8 to 32 characters long, contain at least one number and one letter.
- You can click the “forget password” in login page to reset the password by answering three security questions when you forget the password, if you set the security questions in advance.

Step4: After login, please select “Configuration” → “Basic Settings” → “Network” → “TCP/IP”. The Network Settings page appears (Shown as below Figure);

Step5: Change the IP address or other network values. Then click “Save” button;

Step6: The change of default IP address is completed.

4.2 Accessing from the Web Browser

The camera can be used with the most standard operating systems and browsers. The recommended browsers are Internet Explorer, Firefox, Chrome, Microsoft Edge, Safari.

4.2.1 Access with Plugin

Currently you can only access the camera with plugin via Internet Explorer.

Access over IE Browser

Before using the browser to get access to your camera, you need to install the MsActiveX firstly. You can refer the steps as follows:

Step1: Launch the IE browser and enter the IP address of the camera;

Step2: Enter the User Name and Password and click “Login”;

Step3: At the first time to log in the device, the browser will prompt to install Controls, please click “Click here to download and install controls manually” as shown in the figure below;

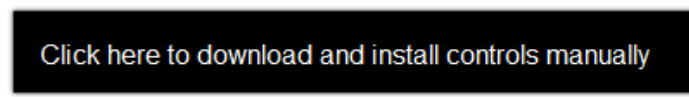

 **Note:** During installing the controls, please keep the browsers close.

Step4: Follow the prompts to install the Controls, when it's finished, it will pop out a window as shown in the figure below. Please click “Finish” and refresh the browser, then you will see the video.

If IE9 or higher version browser is used, it is suggested that the Milesight network cameras web link should be added as a trusted site. See the instructions as follows:

Step1: Start the IE9 or higher version browser, and select “Tools”→“Internet Options”;

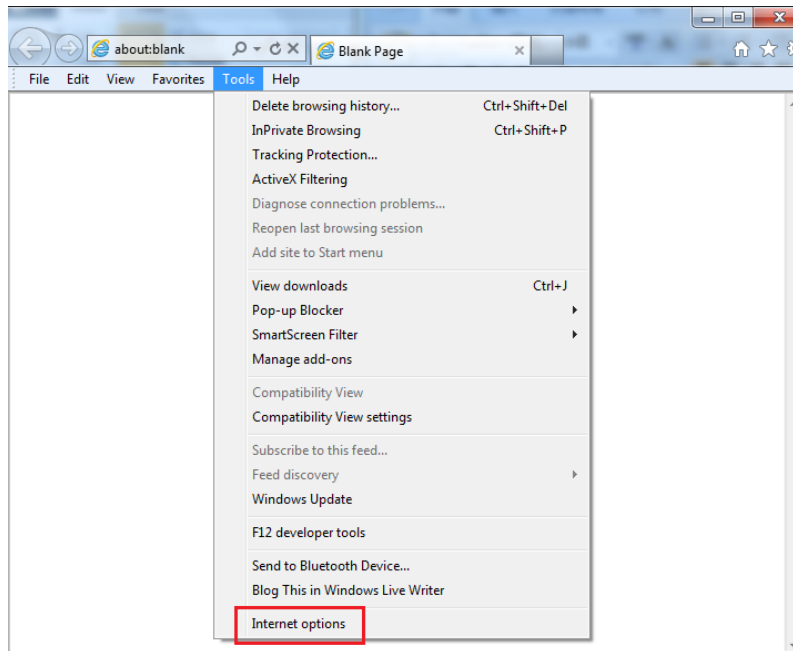

Step2: Select “Security” to “Trusted”;

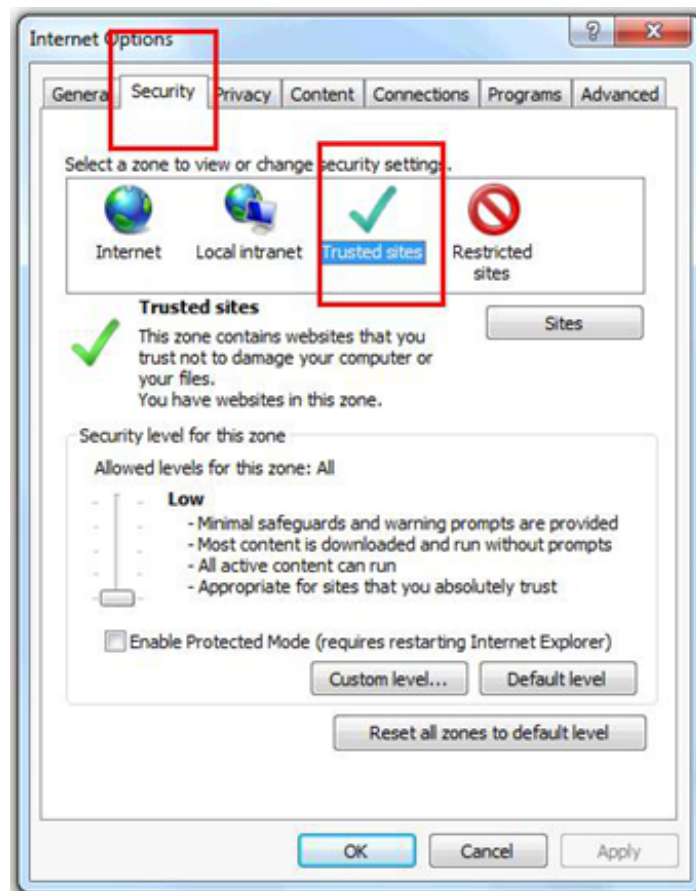

Step3: Enter the IP address of the camera in the blank and click “Add”;

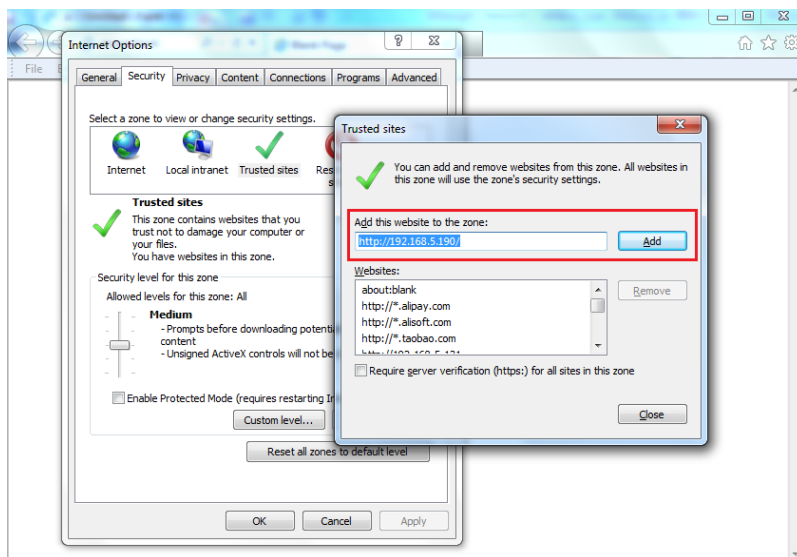

Step4: Enter the IP address. After logging on network camera’s web GUI successfully, user is allowed to view live video as follows.

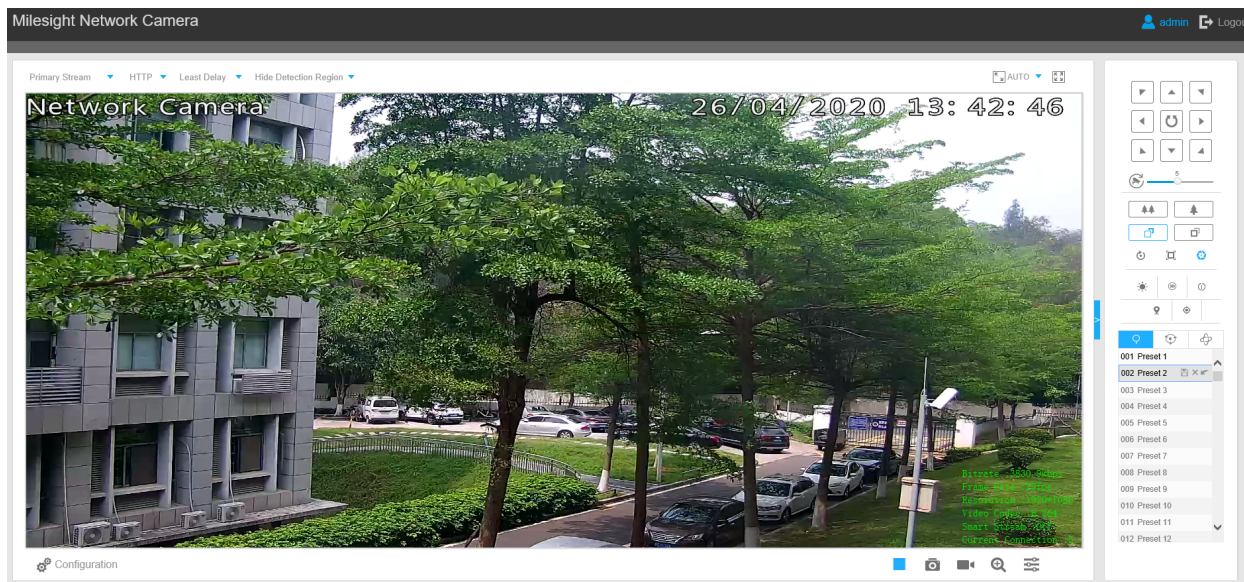

4.2.2 Access without Plugin

As browser security becomes more and more important, some browsers don’t support installing plugin. In order to normally preview the video on the browser, The camera was upgraded to support Plugin-Free Mode. In Plugin-Free Mode, you can preview the video on the browser without plugin. Currently Plugin-Free Mode is supported in Firefox & Google Chrome & Safari & Edge browser for

Windows system, MAC system, iOS system and Android system. Both H.265&H.264 video codec are supported in Plugin-Free Mode for camera, and it will play the secondary stream by default.

Note:

- You need to upgrade camera to V4x.7.0.70 or above to use Plugin-Free Mode.
- For the firmware which below V4x.7.0.74, please upgrade the Network Camera to V4x.7.0.74 or above (Please upgrade the browser to the latest version).
- For V4x.7.0.74 or above, you can enjoy Plugin-Free Mode without any configuration about the browser (Please upgrade the browser to the latest version).

You can preview the video without plugin by selecting Plugin-Free Mode in Live View interface.

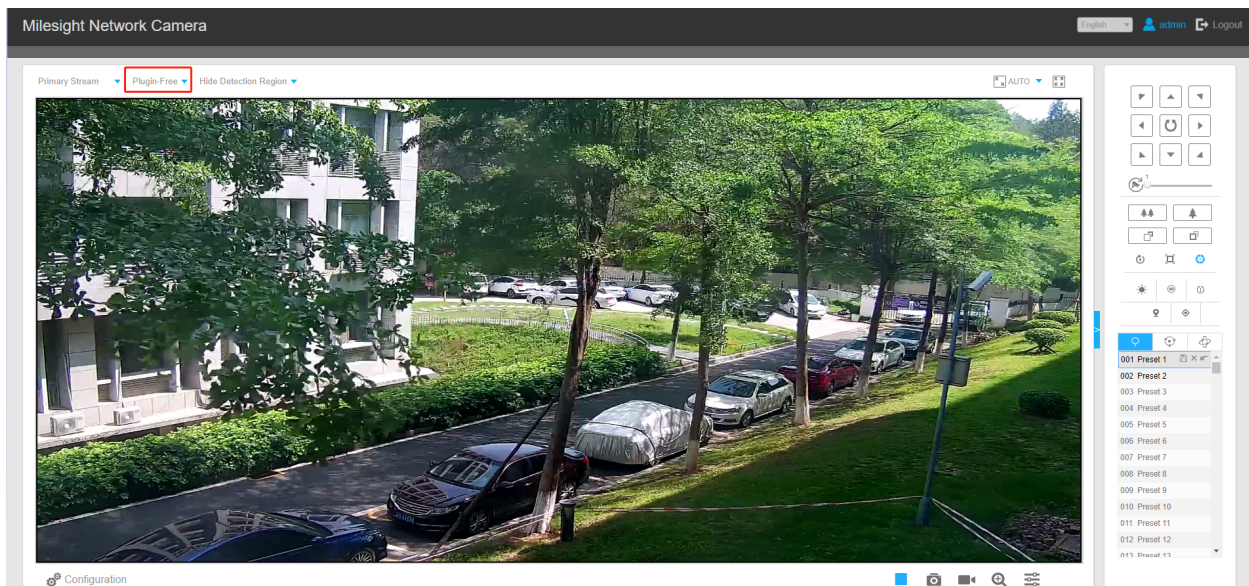

It supports previewing the video in Live View and other setting interfaces.

4.3 Accessing from Milesight VMS (Video Management Software)

Milesight VMS(ONVIF compatible) is a handy and reliable application designed to work with network cameras in order to provide video surveillance, recording settings and event management functions. The interface of Milesight VMS is very easy to use, intuitive, with easy access to the most common activities, such as viewing live video, searching through recordings and exporting videos and snapshots. It's able to be integrated with other devices through ONVIF. It is designed to work on

Windows XP/ 7/ 8/ Vista/ Server 2000/ Server 2008. The software could be downloaded from our website www.milesight.com.

Please install Milesight VMS; then launch the program to add the camera to the channel list. For detailed information about how to use the software, please refer to user manual of Milesight VMS.

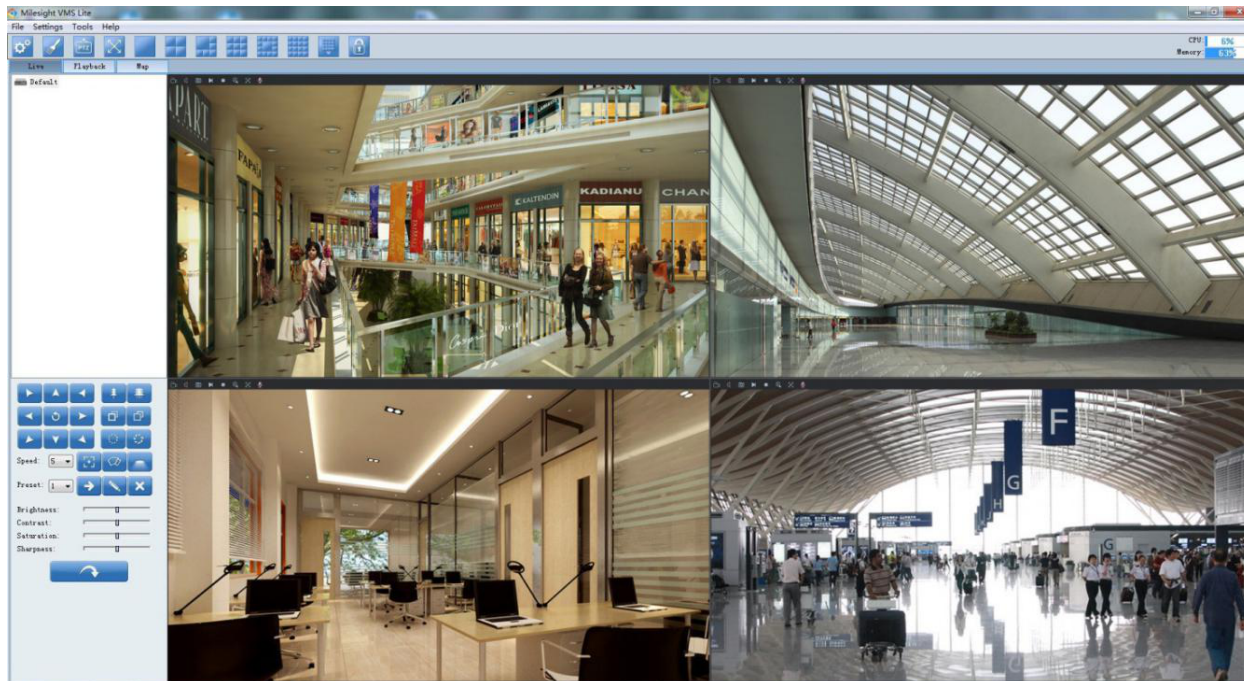

Chapter 5. System Operation Guide

5.1 Live Video



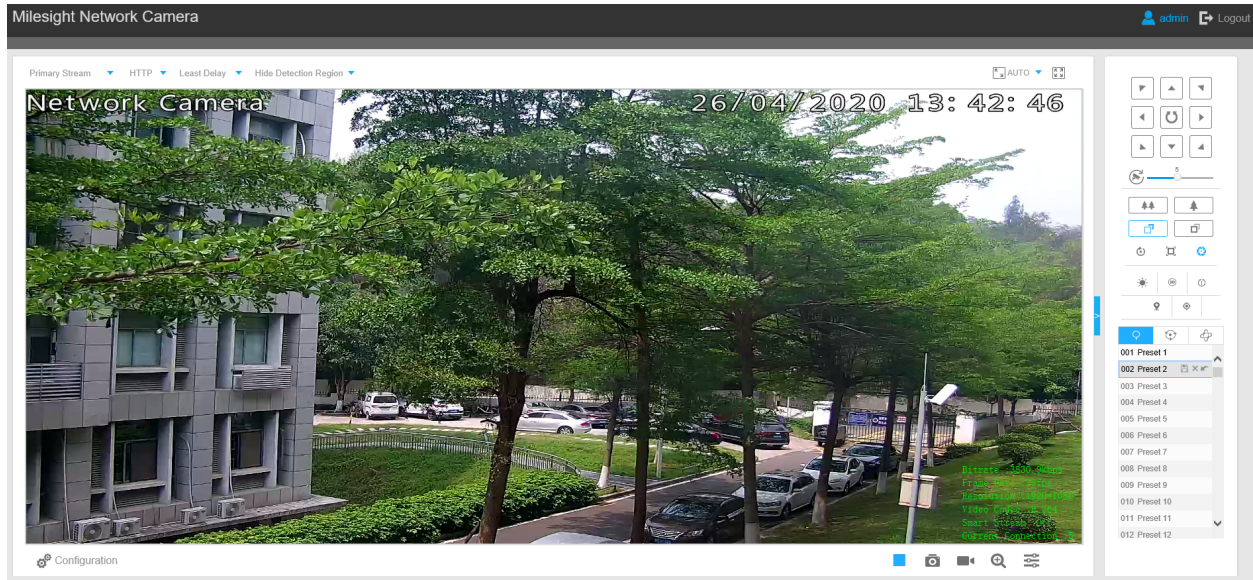



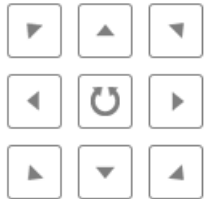

After logging in the network camera web GUI successfully, user is allowed to view live video as follows.







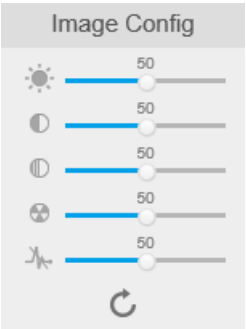

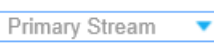











5.1.1 Operations on Live View Page

Table 1. Description of the buttons

No.	Parameter	Description
1	 PTZ Control	Navigation key is used to control the direction. The rotation key is used for auto-rotation.

No.	Parameter	Description
1	 <p>PTZ Speed</p>	To adjust the speed of pan/tilt movements, from 1 to 10
2		Click to zoom in and zoom out
3		Click to focus near or far of the lens
4		Lens Initialization, Auxiliary Focus and Auto Iris
5		Lighting For 30s: Click to open/ close the White LED for lighting 30s.
		3D Positioning: Click to enable/ disable 3D positioning.
		One-touch Patrol: Click to carry out the patrol.
		Auto Home: Click to enable Auto Home.
		Manual Tracking: Click to track the moving objects.
	 <p>Image Config</p>	Brightness: Adjust the Brightness of the scene
		Contrast: Adjust the color and light contrast
		Saturation: Adjust the Saturation of the image. Higher Saturation makes colors appear more "pure" while lower one appears more "wash-out"
		Sharpness: Adjust the Sharpness of image. Higher Sharpness sharpens the pixel boundary and makes the image looks "more clear"
		3D DNR: Adjust the noise reduction level
		Default: Restore brightness, contrast and saturation to default settings
6	 Configuration	Click to access the configuration page
7		Choose the Stream (Primary/Secondary/Tertiary)to show on the current video window

No.	Parameter	Description
8		<p>Only available for camera whose software version is 43 or above</p> <p>Web Components: Support Firefox, Safari, Chrome (Chrome version 44 or below); need to install the component to display the view;</p> <p>MJPEG: Support to display the view on Firefox, Safari, Chrome (Chrome version 45 or above);</p> <p> Note: IE choose Web Components mode for default, in this case, it will not show the options</p>
9		<p>TCP: More reliable connection;</p> <p>UDP: More instantaneous connection, but if you cannot get the live view successfully, please turn into TCP connection;</p> <p>HTTP: Faster and safer connection especially in Internet environment.</p>
10		<p>Least Delay: The most instantaneous mode;</p> <p>Balanced: A balanced mode between Least Delay and Best Fluency, maintains the fluency while keeps an acceptable delay;</p> <p>Best Fluency: The most fluent mode;</p>
11	 AUTO Window size	Click to display images at a window size
12	 100% Real size	Click to display images at a real size
13	 Full Screen	Click to display images at full-screen
14	 Recording	When recording, the icon will turn red
15	 Alarm	When an alarm of Smart Event was triggered, the icon appears

No.	Parameter	Description
16	 Alarm	When an alarm of Motion Detection was triggered, the icon appears
17	 Alarm	Except for the two kinds of alarms above, when other alarms were triggered, the icon appears
18	 Start/Stop live view	Start/Stop live view
19	 Capture	Click to capture the current image and save to the configured path. The default path is: C:\VMS\+-1\ IMAGE-MANUAL
20	 Start Recording	Click to start recording video and save to the configured path. The default path is C:\VMS\+-1\MS_Record. Click again to stop recording
21	 Play Audio	Enable Audio Input/Output. It can also be set in Audio configuration page
22	 Saving Path Settings	Set the saving path for captured images and video recordings of operating on the live view
23	 Enable Digital Zoom	When enabled, you can zoom in in a specific area of video image with your mouse wheel
24	 Start Talking	When it is enabled, you can start real-time talking
25	 English	Click to select system language.

5.1.2 3D Positioning

3D Positioning allows user to use mouse clicking and dragging to control the PTZ.

Steps:

1. Click  on the toolbar of Live View interface.
2. Operate the 3D positioning function
 - Left click a position of the Live View, the corresponding position will be moved to the center of the Live View.
 - Hold down the left mouse button and drag the mouse to the lower right or upper right on the Live View, you can see a blue rectangle. The corresponding position will be moved to the center of the Live View and Zoom in.
 - Hold down the left mouse button and drag the mouse to the lower left or upper left on the Live View, you can see a blue rectangle. The corresponding position will be moved to the center of the Live View and Zoom out.
 - The Bigger the rectangle is, the smaller zoom in/out will be acted.

5.1.3 Set / Call a Preset / Patrol / Pattern

A preset is a predefined image position. You can click the call button from the preset list to quickly go to the desired image position.

Set a preset:

Step1: In the PTZ control panel, select a preset number from the preset list, and you can also customize the preset name displayed on the screen. The patrol name displayed on the screen will also be customized if you customize preset name and set a patrol as shown below;

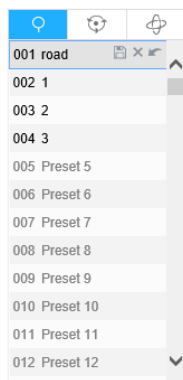

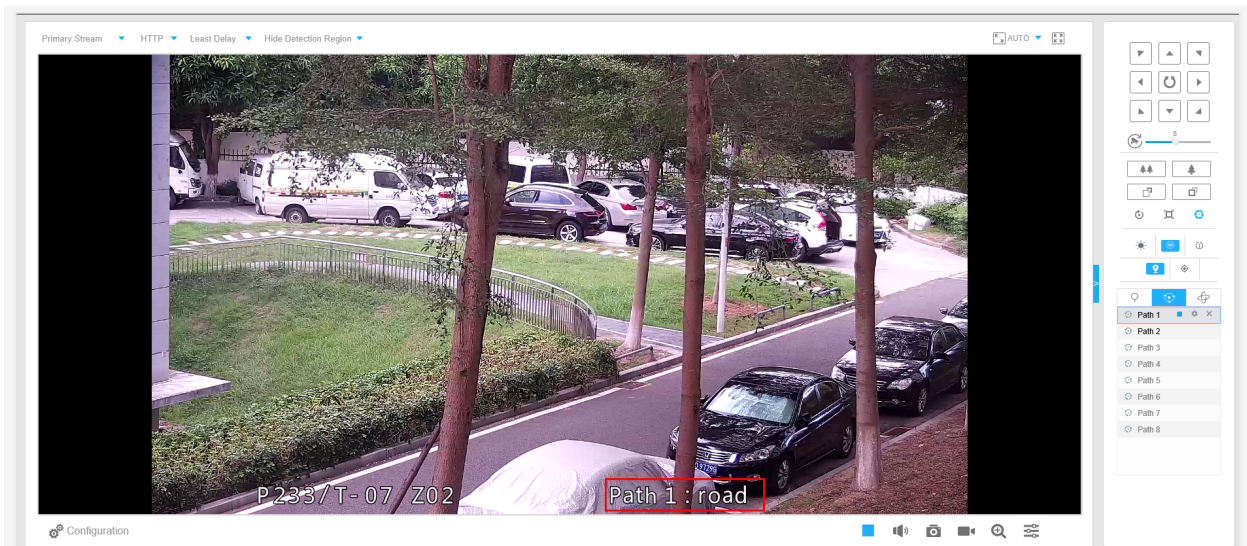
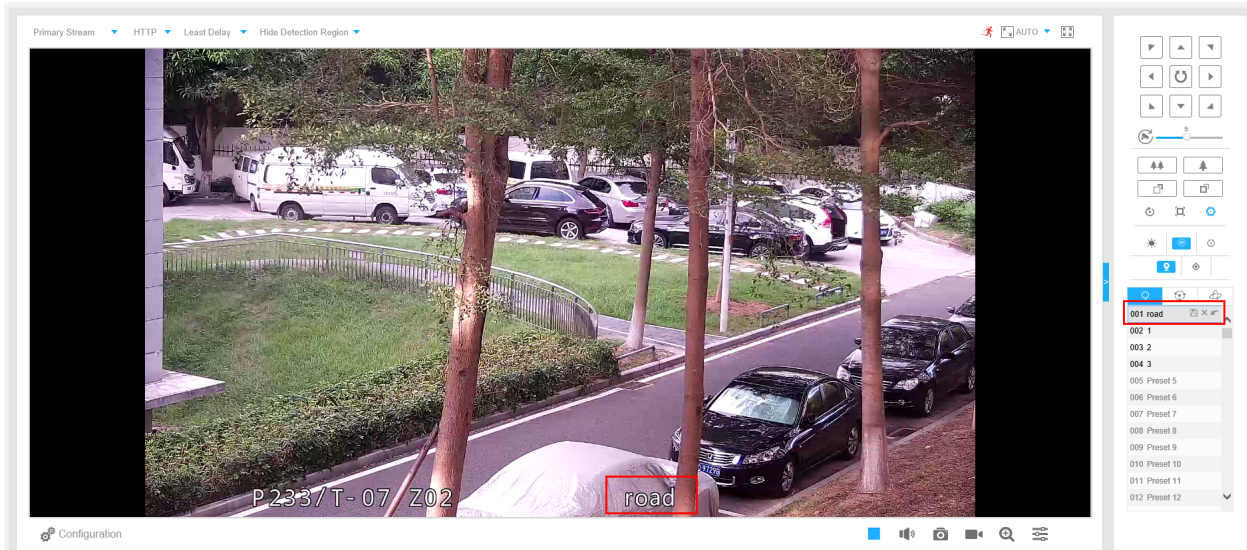

Step2: Use the PTZ control buttons to move the lens to the interested position;

Step3: Click  to save the setting of the current preset;

Step4: Click  to delete the chosen preset.

 **Note:** Up to 300 presets can be configured (18 presets are not modifiable).

Calling a preset:

Select a defined preset from the preset list and click  to call the preset.

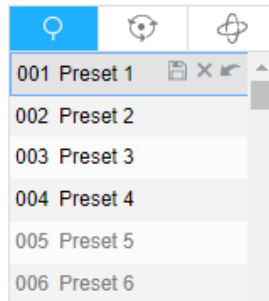

 **Note:** The following presets are predefined with special commands. You can only call them but can't configure them. For example, preset 037 is the "Self Check". If you call the preset number 037, the PTZ camera will start self check function at once.

Table 2. Special Presets

Special Preset	Function	Special Preset	Function
33	Auto Flip(Speed Dome only)	42	Path6
34	Goto Zero	43	Path7
35	Self Check	44	Path8
36	Patrol	45	Pattern1
37	Path1	46	Pattern2
38	Path2	47	Pattern3
39	Path3	48	Pattern4
40	Path4	49	Stop Scan
41	Path5	50	Auto Scan



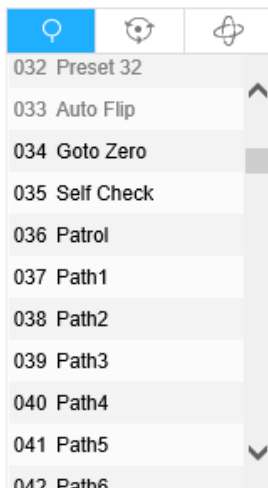

Set / Call a patrol

A patrol is a memorized series of preset function. It can be configured and called on the patrol setting list. You can customize up to 8 patrols and it can be configured with 48 presets. Before configuring the patrol, you should make sure that the presets you want to add to the patrol have been defined.

Set a patrol:

Step1: In the PTZ control panel, click  to enter the patrol settings interface;

Step2: Select a patrol number, the setting icon will appear , click it;

Step3: Click  to add presets to this patrol, as shown in Figure;

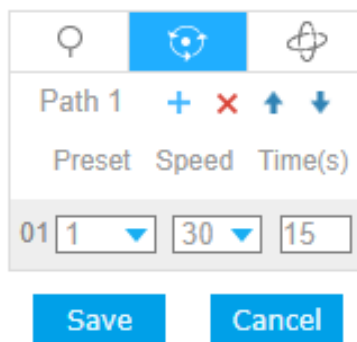

Step4: Configure the preset number, patrol speed and patrol time;

Table 3. Description of Patrol Settings

Name	Description
Patrol Speed	The speed of moving from one preset to another.
Patrol Time	The duration staying on one patrol point. The PTZ camera moves to another patrol point after the set patrol time.

Step5: Click  to save the patrol settings.

Note:

- Patrol Speed only works in Patrol mode.
- Patrol Time should be 15~120s for Mini PTZ Bullet and 0~120s for Speed Dome.

Call a patrol:

In the PTZ control panel, select a defined patrol from the patrol list, and click  to call the patrol, as shown below.

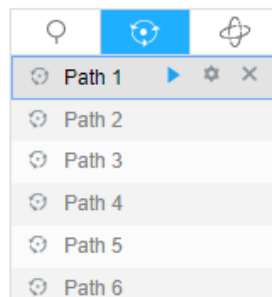

 Note: The three buttons behind the Patrol list means: Play, Set and Delete.

Set / Call a pattern

A pattern is a memorized series of pan, tilt, zoom and preset functions. It can be called on the pattern settings interface. There are up to 4 patterns can be set.

Set a pattern:

Step1: In the PTZ control panel, click  to enter the pattern settings interface;

Step2: Select a pattern number from the pattern list as shown in the figure below;

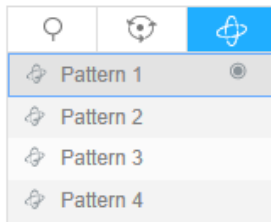

Step3: Click  to activate recording the panning, tilting and zooming actions;

Step4: Use the PTZ controller buttons to move the lens to the interested position;

Step5: Click  to save all the pattern settings.

 **Note:** The percentage of number on the OSD is the remaining space of pattern. Start with 100% and run out of 0%.

Call a pattern:

In the PTZ control panel, select a defined pattern from the pattern list, click  to call the pattern, as shown in the figure below.

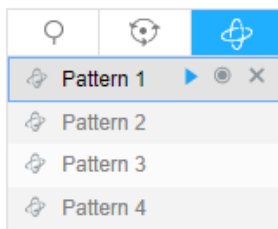

Note:

The three button behind the Pattern list means: Play, Record and Delete.

When configuring the pattern, pan and tilt are valid but the limit stops and auto flip will be invalid. Also, 3D Positioning operation is not supported.

5.2 Playback

This section explains how to view the recorded video files stored in SD cards or NAS.

Step1: Click **Playback** on the menu bar to enter playback interface;

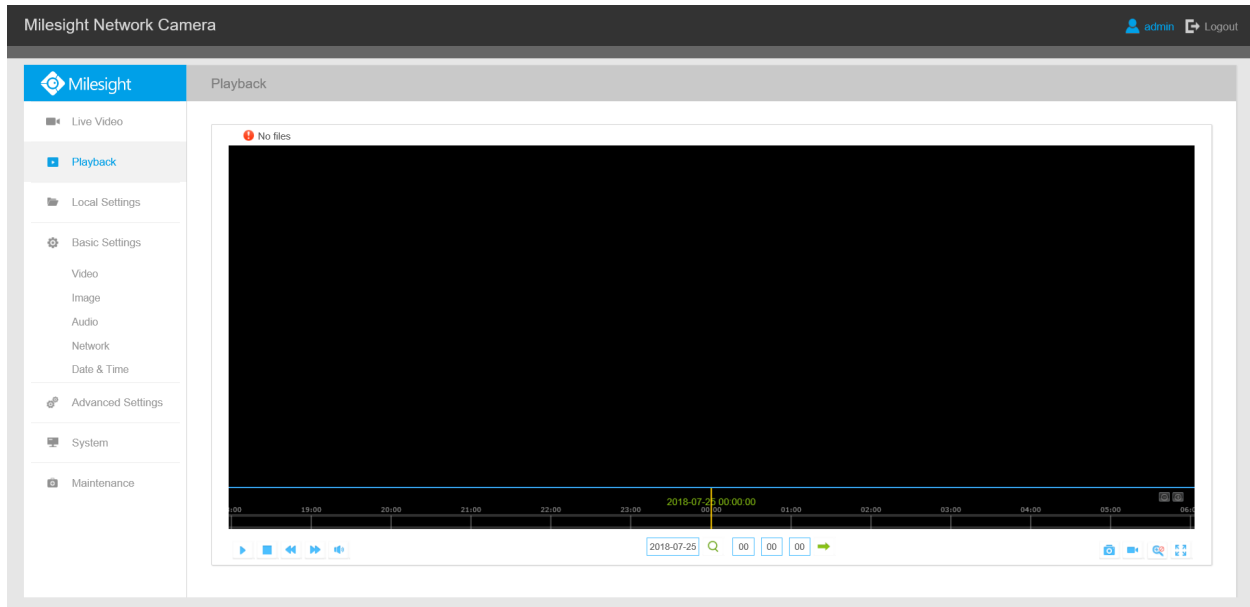

Step2: Click the date button, choose the date when date window pops up;

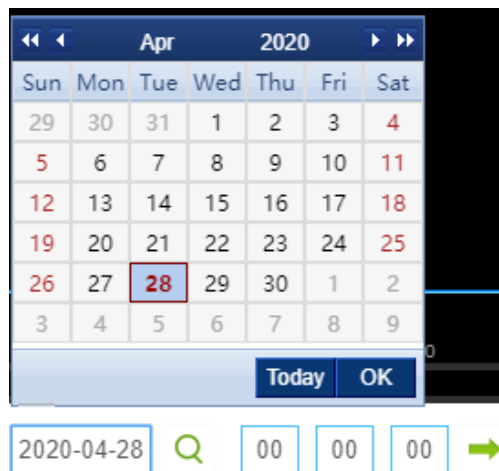

Note:

- The date with bright red means current date; one with a dark red number and white background means weekend day; one with a dark red number and blue background means that the date is selected now.
- It supports Plugin-free Playback function which allows to preview the playback without installing plugin in Firefox (Version 65 and above) & Google Chrome (Version 69 and above). You need to configure the browser properties before using this function. Please refer to for more browser configuration.

Step3: Click  to play the video files found on this date.

The toolbar on the bottom of playback interface can be used to control playing progress.

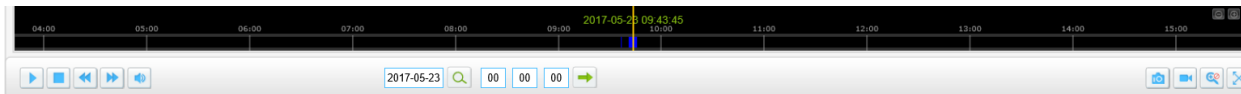











Table 4. Description of the buttons

Button	Operation
	Play
	Pause
	Stop
	Speed Down
	Speed Up
	Audio On/Off
	Search
	Go To
	Time Narrow/Expand
	Start/Stop Recording
	Snapshot
	Zoom On/Off
	Full Screen

 **Note:**

Drag the progress bar with the mouse to locate the exact playback point. You can also input the time and click  to locate the playback point in the **Set Playback Time** field. You can also click  to zoom out/in the progress bar.



5.3 Local Settings

Record File Length and storage path can be customized in this setting page.

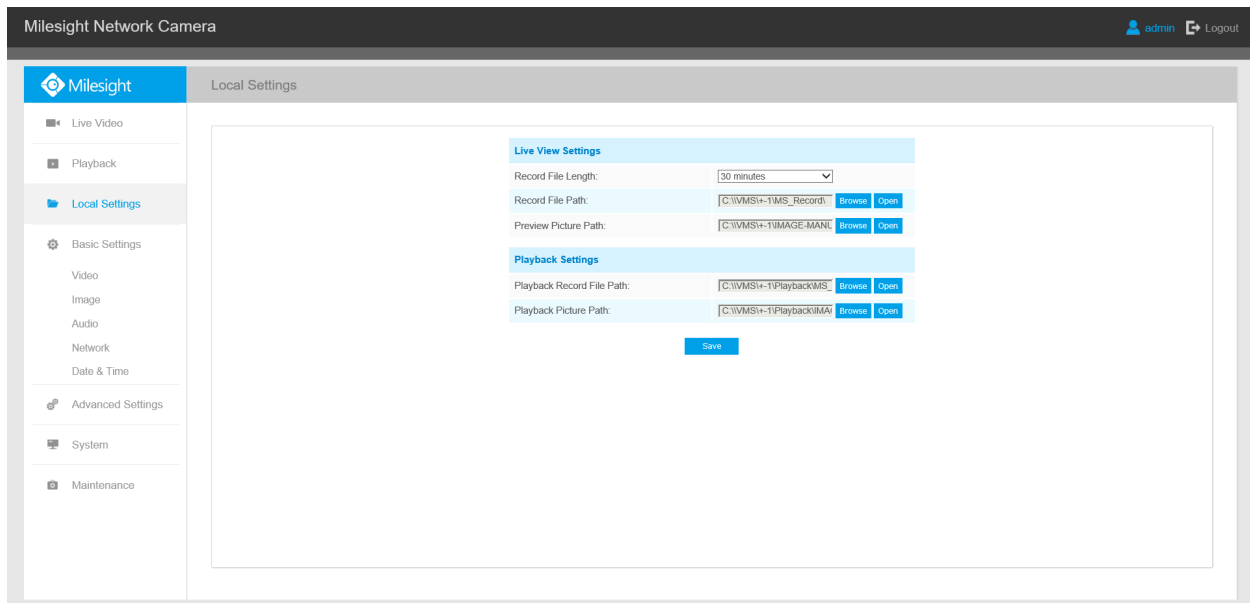

5.4 Basic Settings

5.4.1 Video

Stream parameters can be set in this module, adapting to different network environments and demands.

Primary Stream Settings

Record Stream Type (General)

Basic Settings >> Video

Primary Stream Secondary Stream Tertiary Stream

Record Stream Type :	General
Video Codec :	H.264
Frame Size :	1080P(1920*1080)
Maximum Frame Rate :	25 fps
Bit Rate :	4096 kbps
Smart Stream :	On
Level :	5
Bit Rate Control :	CBR
Profile :	Main
I-frame Interval :	50 frame (1-120)

[Save](#)

Record Stream Type (Event)

Basic Settings >> Video

Primary Stream Secondary Stream Tertiary Stream

Record Stream Type :	Event
Enable Event Stream :	<input checked="" type="checkbox"/>
Video Codec :	H.264
Frame Size :	1080P(1920*1080)
Maximum Frame Rate :	25 fps
Bit Rate :	4096 kbps
Smart Stream :	Off
Bit Rate Control :	CBR
Profile :	Main
I-frame Interval :	50 frame (1-120)

[Save](#)

Secondary Stream Settings

Basic Settings >> Video

Primary Stream Secondary Stream Tertiary Stream

Enable:	<input checked="" type="checkbox"/>
Video Codec:	H.265
Frame Size:	640*480
Maximum Frame Rate:	25 fps
Bit Rate:	512 kbps
Smart Stream:	On
Level:	5
Bit Rate Control:	CBR
Profile:	Main
I-frame Interval:	50 frame(1-120)

[Save](#)

Tertiary Stream Settings

Basic Settings >> Video

Primary Stream Secondary Stream Tertiary Stream

Enable:	<input checked="" type="checkbox"/>
Video Codec:	H.264
Frame Size:	640*480
Maximum Frame Rate:	25 fps
Bit Rate:	1024 kbps
Smart Stream:	On
Level:	5
Bit Rate Control:	CBR
Profile:	Main
I-frame Interval:	50 I-frame(1-120)

Save

Table 5. Description of the buttons

Parameters	Function Introduction
Record Stream Type	<p>General & Event are available only for Primary Stream. General refers to continuous record video, while Event includes events that can trigger alarms, such as Motion, Exception, LPR and so on.</p> <p>This item can separately set different bit rate and frame rate for different Recording Stream Types. If user chooses Event, video will be recorded according to the configuration of video stream type when an event happens, thereby greatly reducing the recording storage space.</p>
Enable Event Stream	This item is optional only if you selected the Event .
Video Codec	H.265/H.264/MJPEG are available
Frame Size	<p>Options include 5M(2592*1944)(only for 5MP Mini PTZ Bullet and 5MP Speed Dome), 4M(2592*1520)(only for 5MP Mini PTZ Bullet and 5MP Speed Dome), 3M(2304*1296), 1080P(1920*1080), 1.3M(1280*960), 720P(1280*720), D1 (704*576).</p> <p>For Secondary Stream, it includes 704*576, 640*480, 640*360, 352*288, 320*240, 320*192, 320*176.</p> <p>For Tertiary Stream, it include 1920*1080, 1280*720, 704*576, 640*480, 640*360, 352*288, 320*240, 320*192, 320*176.</p>
Maximum Frame Rate	Maximum refresh frame rate of per second
Bit Rate	Set the bitrate to 32~16384 Kbps. The higher value corresponds to the higher video quality, and the higher bandwidth is required as well.

Parameters	Function Introduction
Smart Stream	<p>Smart Stream mode remarkably reduces the bandwidth and the data storage requirements for network cameras while ensuring the high quality of images, and it is a 10-level adjustable codec.</p> <p>It is optional to turn On/Off Smart Stream mode.</p> <p>Level: Level 1~10 are available to meet your need.</p>
Bit Rate Control	CBR: Constant Bitrate. The rate of CBR output is constant
	VBR: Variable Bitrate. VBR files vary the amount of output data per time segment
Image Quality	Low/Medium/High are available, this item is optional only if you select VBR.
Profile	The option is for H.264, Main/High/Base can be selected according to your needs.
I-frame Interval	Set the I-frame interval to 1~120, 50 for the default. The number must be a multiple of the number of frames.
JPEG Quality	Low/Medium/High/Higher are available, this item is optional only if you selected the MJPEG

 **Note:** The options of **Frame Size** are variable according to the model selected.

5.4.2 Image

Display information, enhancement of image and Day/Night setting can be set in this module. OSD (On Screen Display) content and video time can be displayed to rich the image information.

Display

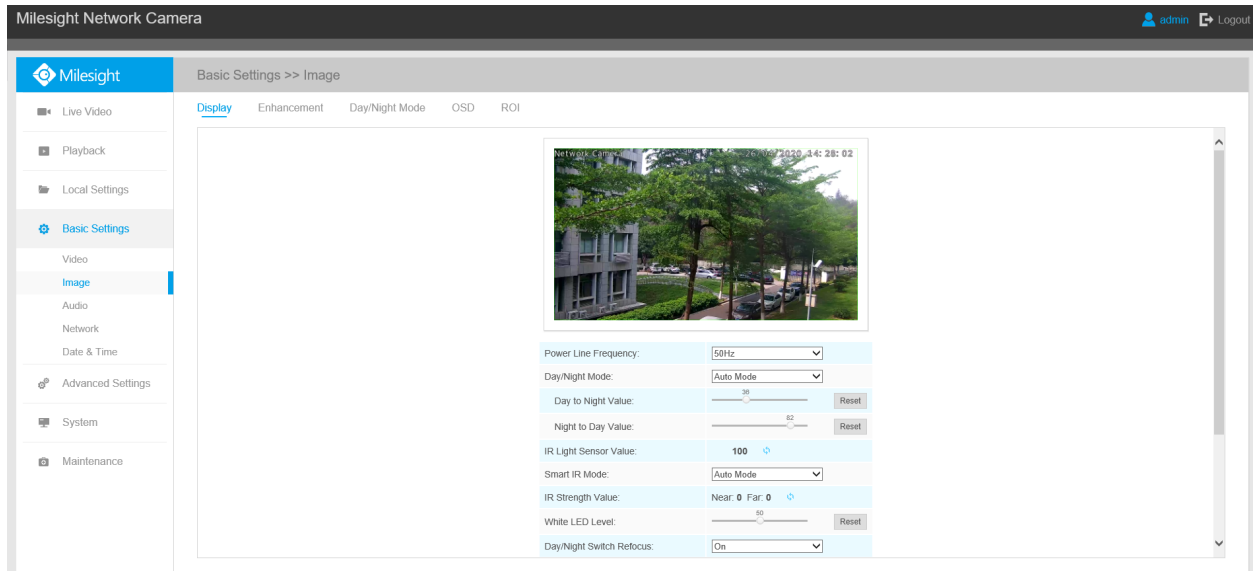

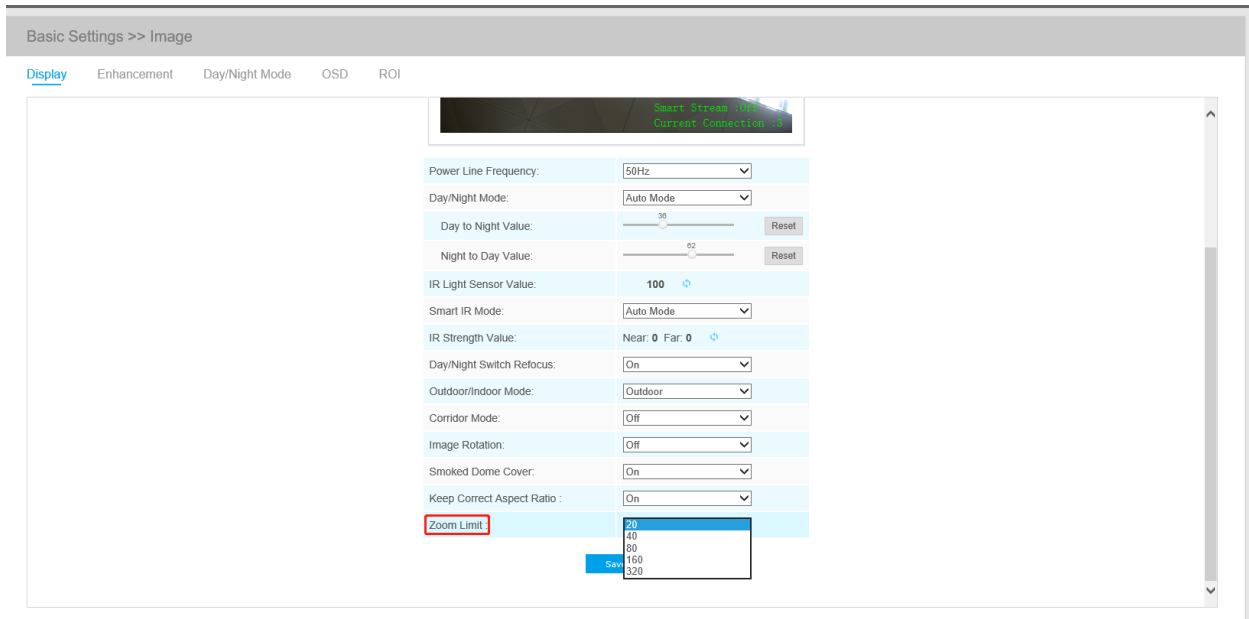

Table 6. Description of the buttons

Parameters	Function Introduction
Power Line Frequency	60Hz flicker for 30fps camera model and 50Hz flicker for 25fps camera model
Day/Night Mode	<p>There are several parameters such as Exposure Level, Maximum Exposure Time and IR-CUT Interval, etc, associated with this mode</p> <p>Night Mode: Shown in live view based on Night Mode settings</p> <p>Day Mode: Shown in live view based on Day Mode settings</p> <p>Auto Mode: Shown in live view based on environment, set the sensitivity for switching Day Mode to Night Mode, or Night Mode to Day Mode</p> <p>Customize: Shown in live view based on your own settings' time to start/end Night Mode</p>
Day To Night Value	This is the sensitivity for switching Day Mode to Night Mode . When IR Light Sensor Current Value is lower than this value, it will switch Day Mode to Night Mode
Night To Day Value	This is the sensitivity for switching Night Mode to Day Mode . When IR Light Sensor Current Value is higher than this value, it will switch Night Mode to Day Mode
IR Light Sensor Value	The current value of the IR light sensor

Parameters	Function Introduction
Smart IR Mode	<p>With the combination of the High Beam and Low Beam, The IR LEDs technology has been upgraded to provide better image clarity and quality regardless of the object distance. Also, the Low Beam and High Beam's brightness can be adjusted manually or automatically on the basis of the Zoom ratio. Moreover, with the IR anti-reflection panel, the infrared light transmittance is highly increased.</p> <p>Support to set the strength of the IR to Auto Mode or Customize to achieve the best effect.</p> <p>Speed Dome has 8 LED lights, 4 are High Beams and 4 are Low Beams. And Mini PTZ Bullet has 4 LED lights, 2 are High Beams and 2 are Low Beams.</p>
Near view level	Adjust the light strength of Low-Beams LED light level from 0 to 100.
Far view level	Adjust the light strength of High-Beams LED light level from 0 to 100.
IR Strength Value	The current value of Low-Beams LED and High-Beams LED light value
Day/Night Switch Refocus	With this option enabled, the camera will refocus when switching between day mode and night mode.
Outdoor/Indoor Mode	Select indoor or outdoor mode to meet your needs
Corridor Mode	<p>There are three options available, you can select one to meet your need</p> <p>Off: Keep the image in normal direction</p> <p>Clockwise 90°: Rotate the image by 90° clockwise</p> <p>Anticlockwise90°: Rotate the image by 90° anticlockwise</p>
Image Rotation	<p>There are four options available, you can select one to meet your need</p> <p>Off: Keep the image in normal direction</p> <p>Rotating 180°: Upside down the image</p> <p>Flip Horizontal: Flip the image horizontally</p> <p>Flip vertical: Flip the image vertically</p>

 **Note:** The PTZ Network Camera which with optical zoom of 20X or above supports Zoom Limit function. Take the 20X Mini PTZ Dome camera as an example:



Enhancement

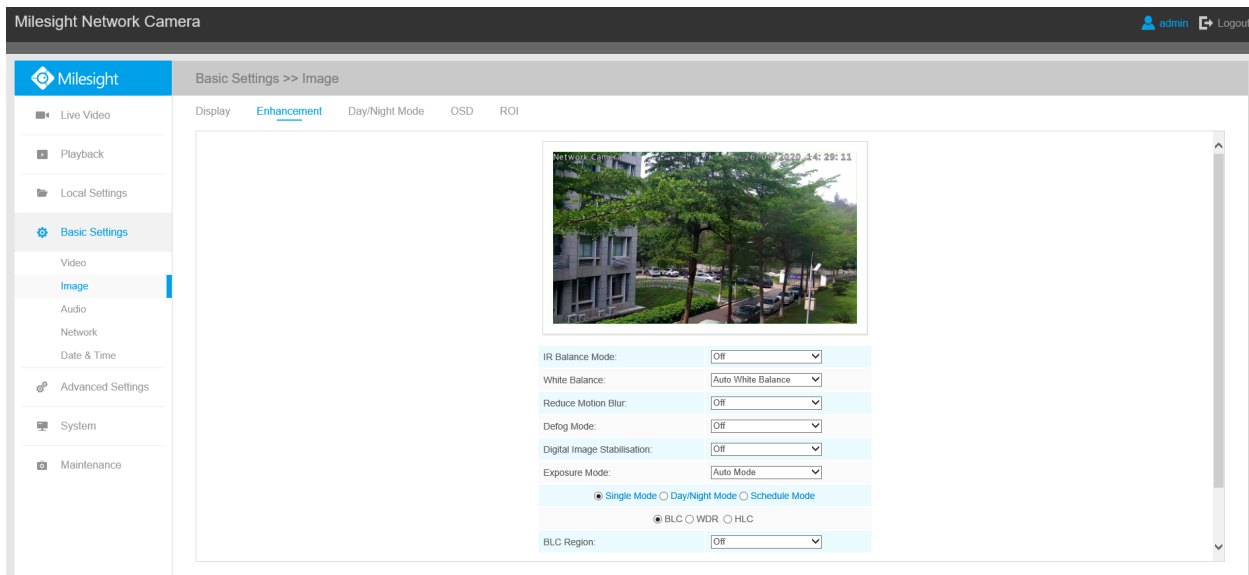

Table 7. Description of the buttons

Parameters	Function Introduction
<p>IR Balance Mode</p>	<p>There is an option to turn On/Off the IR LED.</p> <p>IR Balance Mode would avoid the problem of overexposure and darkness, and the IR LED will change according to the actual illumination.</p>

Parameters	Function Introduction
White Balance	<p>To restore white objects, removed color distortion caused by the light of the environment</p> <p>Auto White Balance:This option will automatically enable the White Balance function</p> <p>Manual White Balance: This option is only for H.265 series. Set Red Gain Level and Blue Gain Level manually.</p> <p>Incandescent Lamp: Select this option when light is similar with incandescent lamp</p> <p>Warm Light Lamp: Select this option when light is similar with warm light lamp</p> <p>Natural Light: Select this option when there is no other light but natural light</p> <p>Fluorescent Lamp: Select this option when light is similar with Fluorescent Lamp</p> <p>Schedule mode: Select this option that you can customize the schedule to enable/disable above modes</p>
Reduce Motion Blur	<p>Enable this function to reduce the motion blur of objects effectively.</p> <p>You can adjust the deblur level from 1 to 100.</p>
Defog Mode	<p>Better image effect in foggy weather.</p>
Digital Image Stabilisation	<p>Decrease the blur and shakiness of the image.</p>
Exposure Mode	<p>Auto Mode, Manual Mode and Schedule Mode are available.</p> <p>Auto Mode: The camera will adjust the brightness according to the light environment automatically;</p> <p>Manual Mode: The camera will adjust the brightness according to the value you set, you can set the exposure time from 1~1/100000s, the higher the value is, the brighter the image is;</p> <p>Schedule Mode: You can customize the schedule to enable/disable Auto Mode and Manual Mode.</p>
Single Mode	<p>Set single mode for BLC/WDR/HLC.</p>
Day/Night Mode	<p>Support BLC/WDR/HLC on Day Enhancement Mode/Night Enhancement Mode separately.</p>
Schedule Mode	<p>Set schedule mode for BLC/WDR/HLC.</p>

Parameters	Function Introduction
BLC Region	<p>Off, Customize, and Centre are available (in single mode, only enable when WDR is disable)</p> <p>Off: Calculate the full range of view and offer appropriate light compensation</p> <p>Customize: This option enables you to customize inclusive or exclusive region manually</p> <p>Centre: This option will automatically add an inclusive region in the middle of the window and give the necessary light compensation</p>
Wide Dynamic Range	<p>This function which can capture and display both bright and dark areas in the same frame enables details of objects in both bright and dark areas to be visible.</p> <p>Off: Disable WDR function</p> <p>On: Enable the WDR, there are Low/High/Auto three levels</p> <p>Customize: Customize the schedule to enable/disable the WDR function and set the levels with Low/High/Auto</p>
Wide Dynamic Level	Set WDR with Low/High/Auto level
Anti-flicker Level	Reduce flickers that appear on screen in some lighting conditions and there are 10 levels of anti-flicker adjustments
High Light Compensation	<p>This function is only for H.265 series to adjust the brightness to a normal range when the light is strong, refers to Figure 4-4-11</p> <p>Off: Disable HLC function</p> <p>General Mode: Enable the general mode of HLC, and there is a setting for HLC Level</p> <p>Enhanced Mode: Enable the enhanced mode of HLC, and there is a setting for HLC Level</p>
HLC Level	Select level for HLC
Day Enhancement Mode	BLC/WDR/HLC are available.
Night Enhancement Mode	BLC/WDR/HLC are available.
Schedule Setting	Customize the schedule to enable/disable BLC/WDR/HLC mode

 **Note:**

- You can customize the schedule to enable/disable the difference White Balance modes.

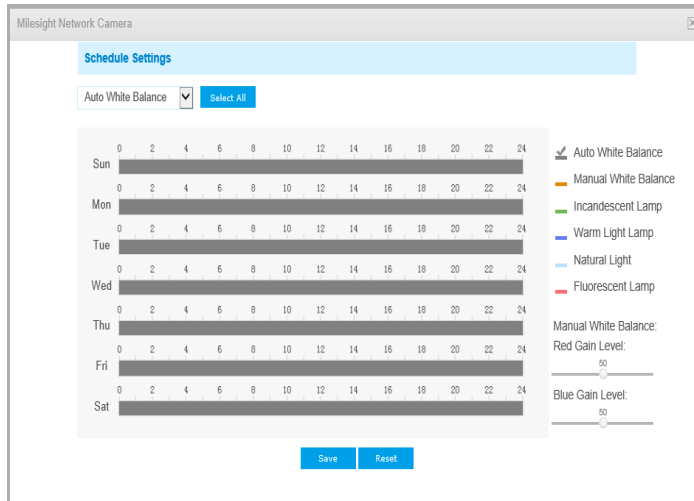

- You can customize the schedule to enable/disable the difference exposure modes.

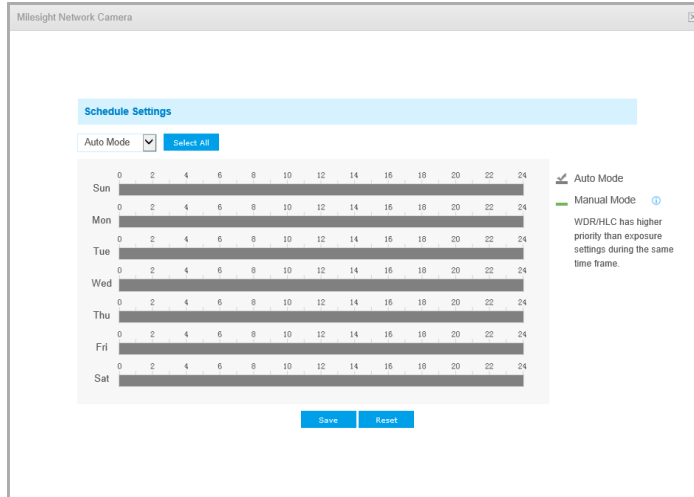

- You can customize the schedule to enable/disable BLC/WDR/HLC mode.

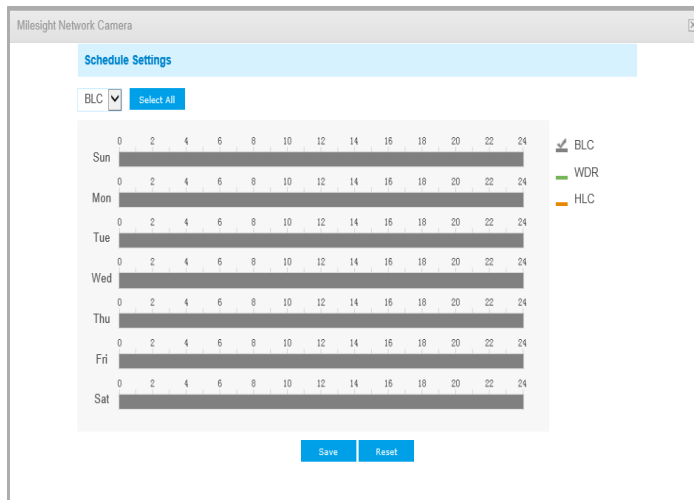

- WDR/HLC has higher priority than exposure settings at the same time frame.
- Defog Image.



- HLC Image.



Day/Night Mode

Milesight Network Camera admin Logout

Basic Settings >> Image

Display Enhancement **Day/Night Mode** OSD ROI

Day/Night Mode

Day/Night Mode	Exposure Level	Minimum Shutter	Maximum Shutter	Limit Gain Level	IR-CUT Latency	IR-CUT	LED	Color Mode
Night Mode:	5	1/25	1/1000000	100	5s	Off	IR LED On	B/W
Day Mode:	5	1/25	1/1000000	100	5s	On	All LED Off	Color

Schedule Mode

<input type="checkbox"/>	Timer	Exposure Level	Minimum Shutter	Maximum Shutter	Limit Gain Level	IR-CUT Latency	IR-CUT	LED	Color Mode
<input type="checkbox"/>	00:00 - 24:00	5	1/25	1/1000000	100	5s	Off	All LED Off	B/W
<input type="checkbox"/>	00:00 - 24:00	5	1/25	1/1000000	100	5s	Off	All LED Off	B/W
<input type="checkbox"/>	00:00 - 24:00	5	1/25	1/1000000	100	5s	Off	All LED Off	B/W
<input type="checkbox"/>	00:00 - 24:00	5	1/25	1/1000000	100	5s	Off	All LED Off	B/W
<input type="checkbox"/>	00:00 - 24:00	5	1/25	1/1000000	100	5s	Off	All LED Off	B/W

Table 8. Description of the buttons

Parameters	Function Introduction
Exposure Level	Level 0~10 are available to meet your need
Minimum Shutter	Minimum Shutter is the same as Maximum Exposure Time. Set the minimum Shutter to 1~1/100000s
Maximum Shutter	Maximum Shutter is the same as Minimum Exposure Time. Set the maximum Shutter to 1~1/100000s
IR-CUT Latency	The interval time of switching one mode to another
IR-CUT	Turn on or turn off IR-CUT
IR LED	Turn on or turn off IR-LED
Color Mode	Select B/W or Color mode under Day/Night mode
Schedule Mode	Here you can customize your special demands for different time, then the Day mode and Night mode will switch automatically according to your settings

On Screen Display(OSD)

The screenshot displays the Milesight Network Camera web interface. At the top, it says 'Milesight Network Camera' and 'admin Logout'. The main navigation bar includes 'Milesight' and 'Basic Settings >> Image'. Below this, there are tabs for 'Display', 'Enhancement', 'Day/Night Mode', 'OSD', and 'ROI'. The 'OSD' tab is selected. On the left side, there is a sidebar menu with various settings categories. The main content area shows a video preview window with a live feed of a street scene. Below the preview, there are several configuration options for the OSD: 'Video Stream' (Primary Stream), 'Font Size' (Medium), 'Font Color' (a color picker), 'Show Video Title' (checked), 'Video Title' (Network Camera), 'Text Position' (Top-Left), 'Show Timestamp' (checked), 'Date Position' (Top-Right), and 'Date Format' (DD/MM/YYYY).

Table 9. Description of the buttons

Parameters	Function Introduction																				
Video Stream	Enable to set OSD for primary stream and secondary stream																				
Font Size	Smallest/Small/Medium/Large/Largest/Auto are available for title and date																				
Font Color	Enable to set different color for title and date																				
Background Color	<p>Enable to set different colors for display information background on screen</p> <p>You can set different colors for font and background of image , then the image OSD will show as below:</p> <div data-bbox="570 741 1243 1140" data-label="Image"> </div> <div data-bbox="558 1163 1252 1633" data-label="Form"> <table border="1"> <tr> <td>Video Stream:</td> <td>Primary Stream</td> </tr> <tr> <td>Font Size:</td> <td>Medium</td> </tr> <tr> <td>Font Color:</td> <td></td> </tr> <tr> <td>Background Color:</td> <td><input checked="" type="checkbox"/></td> </tr> <tr> <td></td> <td></td> </tr> <tr> <td>Show Video Title:</td> <td><input checked="" type="checkbox"/></td> </tr> <tr> <td>Video Title:</td> <td>Network Camera</td> </tr> <tr> <td>Text Position:</td> <td>Top-Left</td> </tr> <tr> <td>Show Timestamp:</td> <td><input checked="" type="checkbox"/></td> </tr> <tr> <td>Date Position:</td> <td>Top-Right</td> </tr> </table> </div>	Video Stream:	Primary Stream	Font Size:	Medium	Font Color:		Background Color:	<input checked="" type="checkbox"/>			Show Video Title:	<input checked="" type="checkbox"/>	Video Title:	Network Camera	Text Position:	Top-Left	Show Timestamp:	<input checked="" type="checkbox"/>	Date Position:	Top-Right
Video Stream:	Primary Stream																				
Font Size:	Medium																				
Font Color:																					
Background Color:	<input checked="" type="checkbox"/>																				
																					
Show Video Title:	<input checked="" type="checkbox"/>																				
Video Title:	Network Camera																				
Text Position:	Top-Left																				
Show Timestamp:	<input checked="" type="checkbox"/>																				
Date Position:	Top-Right																				
Show Video Title	Check the checkbox to show video title																				
Video Title	Customize the OSD content																				

Parameters	Function Introduction
Text Position	OSD display position on the image
Show Timestamp	Check the checkbox to display date on the image
Date Position	Date display position on the image
Date Format	The format of date
Copy to Other Streams	Copy the settings to other streams

ROI

Region of interest (often abbreviated ROI), is a selected subset of samples within a dataset identified for a particular purpose. Users can select up to 8 key regions of a scene to transmit through separate streams for targeted preview and recording.

By using Milesight ROI technology, more than 50% of bit rate can be saved and therefore less bandwidth demanded and the storage usage reduced. So according to this, you can set a small bit rate for high resolution.

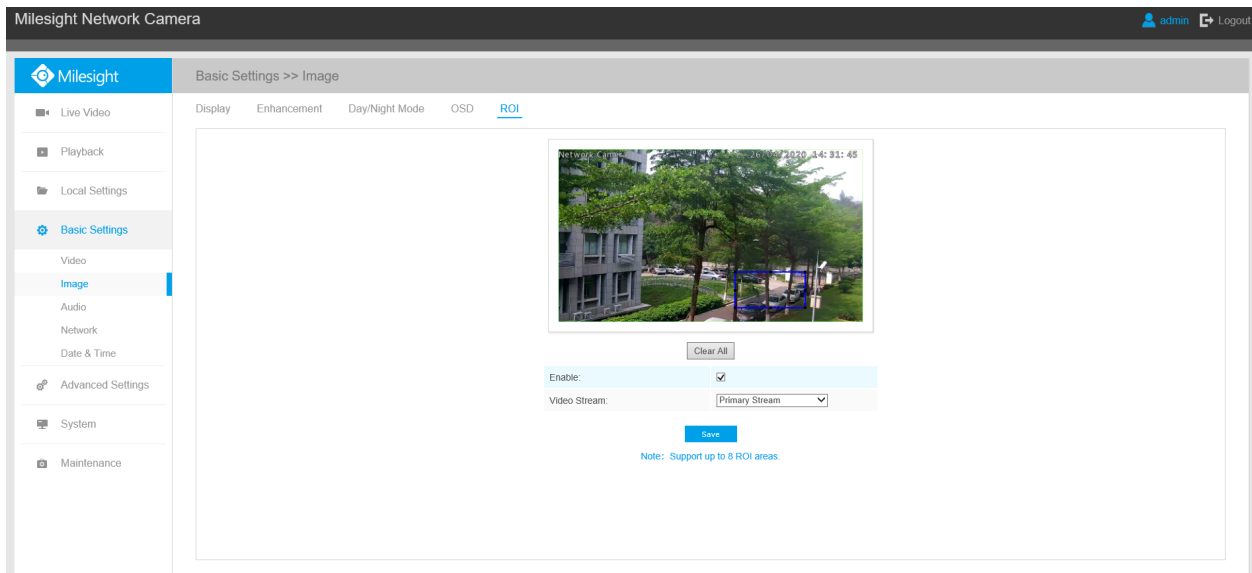

Table 10. Description of the buttons

Parameters	Function Introduction
Enable	Check the checkbox to enable the ROI function
Clear All	Clear all areas you drew before
Video Stream	Choose the Video Stream

Note:

- You can set a low bit rate. For example, you can set a bit rate with 512Kbps and a resolution with 1080P, then you can see the image quality of ROI is more clear and fluent than the other region.

5.4.3 Audio

This audio function allows you to hear the sound from the camera or transmit your sound to the camera side. A two-way communication is also possible to be achieved with this feature. Alarm can be triggered when the audio input is above a certain alarm level you set, and configured audio can be played when an alarm occurs.

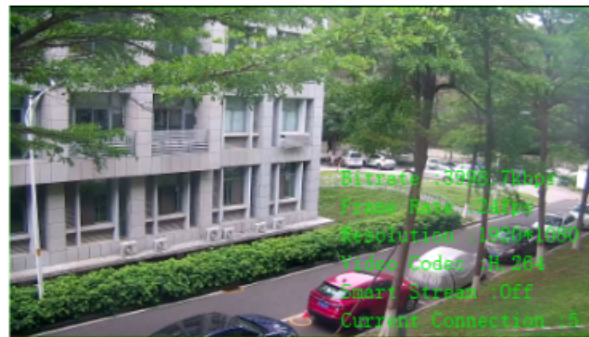

Enable Audio:	<input checked="" type="checkbox"/>
Audio Mode:	Both Audio Input & Output
Audio Input	
Denoise:	<input type="checkbox"/>
Encoding:	AAC LC
Sample Rate:	48KHz
Audio Bit Rate:	144kbps
Input Gain:	<input type="range" value="79"/>
Audio Output	
Auto Gain Control:	<input checked="" type="checkbox"/>
Output Volume:	<input type="range" value="78"/>
<input type="button" value="Save"/>	

Table 11. Description of the buttons

Parameters	Function Introduction
Enable Audio	Check on the check box to enable audio feature
Audio Input	<p>Denoise: Set it as On/Off. When you set the function on, the noise detected can be filtered</p> <p>Encoding: G.711-ULaw, G.711-ALaw, AAC LC, G.722 and G.726 are available</p> <p>Audio Bit Rate: The function is available only for AAC LC, and supports up to 256kbps</p> <p>Sample Rate: 8KHz, 16KHz, 32KHz, 44.1KHz, and 48KHz are available</p> <p>Input Gain: Input audio gain level, 0-100</p> <p>Alarm Level: Alarm will be triggered if voice alarm is enabled and input gained volume is higher than the alarm level, 1-100</p>
Audio Output	<p>Auto Gain Control: This function is only for H.265 series, improve the quality of audio</p> <p>Output Volume: Adjust volume of output</p>

You can upload up to 5 audio files manually to Flash or SD Card on the Audio web page and you can also edit the audio file's name when upload.

Audio File Storage Type:

Audio File Upload

Audio File Name:

Audio File:

ID	Audio File Name	Delete
1	audio	<input type="button" value="✘"/>

Note: Only support '.wav' audio files with codec type PCM/PCMU/PCMA, 64kbps or 128kbps bitrate and no more than 500k!

 **Note:** Only support '.wav' audio files with codec type PCM/PCMU/PCMA, 64kbps or 128 kbps and no more than 500k.

5.4.4 Network

TCP/IP

Get IPv4 address automatically

Use fixed IPv4 address

IP Address:

IPv4 Subnet Mask:

IPv4 Default Gateway:

Preferred DNS Server:

IPv6 Mode:

IPv6 Address:

IPv6 Prefix:

IPv6 Default Gateway:

Table 12. Description of the buttons

Parameters	Function Introduction
Get IPv4 Address Automatically	Get an IP address from the DHCP server automatically
Use fixed IP address	<p>IPv4 Address: An address that used to identify a network camera on the network</p> <p>IPv4 Subnet Mask: It is used to identify the subnet where the network camera is located</p> <p>IPv4 Default Gateway: The default router address</p> <p>Preferred DNS Server: The DNS Server translates the domain name to IP address</p> <p>IPv6 Mode: Choose different mode for IPv6: Manual/Route Advertisement/ DHCPv6</p> <p>IPv6 Address: IPv6 Address used to identify a network camera on the network</p> <p>IPv6 Prefix: Define the prefix length of IPv6 address</p> <p>IPv6 Default Gateway: The default router IPv6 address</p> <p>MTU: Maximum Transmission Unit. The default value is 1500. You can customize the value from 1200 to 1500 as needed</p>

 **Note:** The **Test** button is used to test if the IP is conflicting.

HTTP

HTTP Enable:	<input checked="" type="checkbox"/>
HTTP Port:	<input type="text" value="80"/>
HTTPS Enable:	<input checked="" type="checkbox"/>
HTTPS Port:	<input type="text" value="443"/>

HTTPS Settings

Installed Certificate:

Attributes:

Awarded to:
C=US, H/IP=IPC
Issuer:
C=US, H/IP=IPC
Period of Validity:
Dec 18 06:46:09 2019 ~
Sep 12 06:46:09 2022

Installation Type:

Create a Private Certificate:



Table 13. Description of the buttons

Parameters	Function Introduction
HTTP Enable	Start or stop using HTTP
HTTP Port	Web GUI login port, the default is 80, the same with ONVIF port
HTTPS Enable	Start or stop using HTTPS
HTTPS Port	Web GUI login port via HTTPS, the default is 443
HTTP Settings	Upload and set the SSL certificate.

Table 14. HTTP URL are as below:

Stream	URL
Main Stream	http://username:password@IP:port/ipcam/mjpeg.cgi
Secondary Stream	http://username:password@IP:port/ipcam/mjpegcif.cgi
Tertiary Stream	http://username:password@IP:port/ipcam/mjpegthird.cgi

RTSP

RTSP Port:	<input type="text" value="554"/>	
Playback Port:	<input type="text" value="555"/>	
RTP Packet:	<input type="text" value="Better Compatibility"/>	
Multicast Group Address:	<input type="text" value="239 . 6 . 6 . 6"/>	
QoS DSCP(0~63):	<input type="text" value="0"/>	

Save

Table 15. Description of the buttons

Parameters	Function Introduction
RTSP Port	The port of RTSP, the default is 554
Playback Port	Playback Port The port of playback, the default is 555
RTP Packet	There are Better Compatibility and Better Performance two options, if your camera's image mess up, please switch this option
Multicast Group Address	Support multicast function
QoS DSCP	The valid value range of the DSCP is 0-63

Table 16. RTSP URL are as below:

Stream	URL
Main Stream	rtsp://username:password@IP:port/main
Secondary Stream	rtsp://username:password@IP:port/sub
Tertiary Stream	rtsp://username:password@IP:port/third

 **Note:**

- Get the format of RTSP URL by clicking “

UPnP

Universal Plug and Play (UPnP) is a networking architecture that provides compatibility among networking equipment, software and other hardware devices. The UPnP protocol allows devices to connect seamlessly and to simplify the implementation of networks in the home and corporate environments. With the function enabled, you don't need to configure the port mapping for each port, and the camera is connected to the Wide Area Network via the router.

Enable UPnP:

Port Mapping

Enable Port Mapping:

Name:

Type:

Protocol Name	External Port	Internal Port	Status
HTTP	<input type="text" value="21202"/>	<input type="text" value="80"/>	Invalid
RTSP	<input type="text" value="23202"/>	<input type="text" value="554"/>	Invalid
Playback	<input type="text" value="25202"/>	<input type="text" value="555"/>	Invalid

Table 17. Description of the buttons

Parameters	Function Introduction
Enable	Check the checkbox to enable the UPnP function
Enable Port Mapping	Check the checkbox to enable the Port Mapping
Name	The name of the device detected online can be edited
Type	<p>Auto: Automatically obtain the corresponding HTTP and RTSP port, without any settings</p> <p>Manual: Need to manually set the appropriate HTTP port and RTSP Port. When choose Manual, you can customize the value of the port number by yourself</p>

DDNS

DDNS allows you to access the camera via domain names instead of IP address. It manages to change IP address and update your domain information dynamically. You need to register an account from a provider.

DDNS is not running

Enable DDNS:	<input type="checkbox"/>
Provider:	ddns.milesight.com ▼
External HTTP Port :	80
External RTSP Port:	554
External Playback Port:	555
DDNS URL: http://ddns.milesight.com/210C1E	

Note: Recommend to enable and configure UPnP ports which can be used directly in DDNS.

Save

You can choose “ddns.milesight.com” as provider for DDNS. After enabling it, you can access the device via the URL “http://ddns.milesight.com/MAC address”.

Table 18. Description of the buttons

Parameters	Function Introduction
Enable DDNS	Check the checkbox to enable DDNS service
Provider	Get support from DDNS provider: ddns.milesight.com, freedns.afraid.org, dyndns.org, www.no-ip.com, www.zoneedit.com. You can also customize the provider for DDNS.
Hash	A string used for verifying, only for "freedns.afraid.org"
User name	Account name from the DDNS provider, unavailable for "freedns.afraid.org"
Password	Account password, unavailable for "freedns.afraid.org"
Host name	DDNS name enabled in the account

 **Note:**

- Please do the Port Forwarding of HTTP Port and RTSP Port before you use Milesight DDNS.
- Make sure that the internal and the external port number of RTSP are the same.

Email

Alarm video files can be sent to specific mail account through SMTP server. You must configure the email settings correctly before using it.

Enable:	<input type="checkbox"/>
User Name:	<input type="text" value="hdipnc"/>
Sender Email Address:	<input type="text" value="hdipnc@sina.com"/>
Password:	<input type="password" value="•••••"/>
Email Server:	<input type="text" value="smtp.sina.com"/>
Email Port:	<input type="text" value="25"/>
Recipient Email Address1:	<input type="text" value="user@domain.com"/>
Recipient Email Address2:	<input type="text"/>
Encryption:	<input type="radio"/> SSL <input type="radio"/> TLS
Snapshot Settings	
Alarm Snapshot File Name:	<input type="text" value="Customize"/> <input type="button" value="Reset"/>
	<input type="text" value="&Device_&Y&M&D_&h&m"/> <input type="button" value="Reset"/>
	<input type="text" value="Network Camera_2021061"/> <input type="button" value="Reset"/>
Timing Snapshot File Name:	<input type="text" value="Add prefix"/> <input type="text"/>
	<input type="text"/>
	<input type="button" value="Save"/> <input type="button" value="Test"/>

Table 19. Description of the buttons

Parameters	Function Introduction
Enable	Check the checkbox to enable Email function
User Name	The sender's name. It is usually the same as the account name
Sender Email Address	Email address to send video files attached emails
Password	The password of the sender

Parameters	Function Introduction
SMTP Server	The SMTP server IP address or host name(e.g. smtp.gmail.com)
SMTP Port	The default TCP/IP port for SMTP is 25(not secured). For SSL/TLS port, it depends on the mail you use
Recipient Email Address1	Email address to receive video files
Recipient Email Address2	Email address to receive video files
Encryption	Check the checkbox to enable SSL or TLS if it is required by the SMTP server.
Alarm Snapshot File Name	Default(YYYY-MM-DD) /MM-DD-YYYY/ DD-MM-YYYY/ Add prefix/ Overwrite with the base file name/ Customize are available.
Timing Snapshot File Name	Default(YYYY-MM-DD) /MM-DD-YYYY/ DD-MM-YYYY/ Add prefix/ Overwrite with the base file name/ Customize are available.

 **Note:** You can refer to the following file name tip to customize the file name.

File Name Tip:
 &Device - Device Name
 &Y - Year
 &M - Month
 &D - Day
 &h - hour
 &m - minute
 &s - second
 && - &

FTP

Alarm video files can be sent to specific FTP server. You must configure the FTP settings correctly before using it.

FTP Server Settings	
Server Address:	<input type="text" value="192.168.5.1"/>
Server Port:	<input type="text" value="21"/>
User Name:	<input type="text" value="admin"/>
Password:	<input type="password" value="••••••"/>
FTP over SSL/TLS(FTPS):	<input type="checkbox"/>

FTP Storage Settings	
Storage Path:	<input type="text" value="Child Directory"/>
Parent Directory:	<input type="text" value="Date"/>
Child Directory:	<input type="text" value="IP Address"/>
Alarm Action File Name:	<input type="text" value="Customize"/>
Video File Name:	<input type="text" value="YYYY-MM-DD"/>
Image File Name:	<input type="text" value="YYYY-MM-DD"/>
Timing Snapshot File Name:	<input type="text" value="Default(YYYY-MM-DD)"/>
Pre-record:	<input type="text" value="0 second"/>

Save
Test

Table 20. Description of the buttons

Parameters	Function Introduction
Server Address	FTP server address
Server Port	The port of the FTP server. Generally it is 21
User Name	User name used to log in to the FTP sever
Password	User password

Parameters	Function Introduction
Storage Path	Storage Path where video and image will be uploaded to the FTP server. Four FTP storage path types are available, including Root Directory, Parent Directory, Child Directory and Customize.
Parent Directory	Choose IP Address/ Device Name/ Date as the folder name of Parent Directory, or customize the folder name.
Child Directory	Choose IP Address/ Device Name/ Date as the folder name of Child Directory, or customize the folder name.
Multilevel Folder Name	If the storage path is more than two levels, enter Multilevel FTP storage path here manually.
Alarm Action File Name	Choose the default(YYYY-MM-DD) or customize the alarm action file name.
Video File Name	If you choose to customize the alarm action file name, YYYY-MM-DD/ MM-DD-YYYY/ DD-MM-YYYY/ Add prefix are available.
Image File Name	If you choose to customize the alarm action file name, YYYY-MM-DD/ MM-DD-YYYY/ DD-MM-YYYY/ Add prefix are available.
Timing Snapshot File Name	Default(YYYY-MM-DD) /MM-DD-YYYY/ DD-MM-YYYY/ Add prefix/ Overwrite with the base file name are available.

 **Note:**

- Parent Directory will be under Root Directory, and Child Directory will be under Parent Directory.
- You can refer to the following file name tip to customize the file name.

File Name Tip:
 &Device - Device Name
 &Y - Year
 &M - Month
 &D - Day
 &h - hour
 &m - minute
 &s - second
 && - &

VLAN

A virtual LAN (VLAN) is any broadcast domain that is partitioned and isolated in a computer network at the data link layer (OSI layer 2). LAN is an abbreviation of local area network. VLANs allow network administrators to group hosts together even if the hosts are not on the same network switch. This can greatly simplify network design and deployment, because VLAN membership can be configured through software. Without VLANs, grouping hosts according to their resource needs necessitates the labour of relocating nodes or rewiring data links.

VLAN Enable:	<input checked="" type="checkbox"/>
VLAN ID(1~4094):	<input type="text" value="1"/>
VLAN IP:	<input type="text" value="."/> <input type="text" value="."/> <input type="text" value="."/>
VLAN Netmask:	<input type="text" value="."/> <input type="text" value="."/> <input type="text" value="."/>
VLAN Gateway:	<input type="text" value="."/> <input type="text" value="."/> <input type="text" value="."/>

[Save](#)

 **Note:** How to set up VLAN in switches, please refers to your switches user manual.

PPPoE

This camera supports the PPPoE auto dial-up function. The camera gets a public IP address by ADSL dial-up after the camera is connected to a modem. You need to configure the PPPoE parameters of the network camera.

Enable PPPoE:	<input type="checkbox"/>
Dynamic IP:	<input type="text" value="0.0.0.0"/>
User Name:	<input type="text"/>
Password:	<input type="text"/>
Confirm Password:	<input type="text"/>

[Save](#)

 **Note:**

- The obtained IP address is dynamically assigned via PPPoE, so the IP address always changes after rebooting the camera. To solve the inconvenience of the dynamic IP, you need to get a domain name from the DDNS provider (e.g. DynDns.com).
- The user name and password should be assigned by your ISP.

SNMP

You can set the SNMP function to get camera status, parameters and alarm related information and manage the camera remotely when it is connected to the network.

Before setting the SNMP, please download the SNMP software and manage to receive the camera information via SNMP port. By setting the Trap Address, the camera can send the alarm event and exception messages to the surveillance center.

SNMP v1/v2	
SNMP V1 Enable:	<input type="checkbox"/>
SNMP V2c Enable:	<input type="checkbox"/>
Write Community:	<input type="text" value="public"/>
Read Community:	<input type="text" value="private"/>
SNMP v3	
SNMP V3 Enable:	<input type="checkbox"/>
Read Security Name:	<input type="text"/>
Level of Security:	<input type="text" value="no auth,no priv"/>
Write Security Name:	<input type="text"/>
Level of Security:	<input type="text" value="no auth,no priv"/>
SNMP Port	
SNMP Port:	<input type="text" value="161"/>

Table 21. Description of the buttons

Parameters	Function Introduction
SNMP v1/2/3	The version of SNMP, please select the version of your SNMP software. SNMP v1: Provide no security SNMP v2: Require password for access SNMP v3: Provide encryption and the HTTPS protocol must be enabled
Write Community	Input the name of Write Community
Read Community	Input the name of Read Community
Read Security Name	Input the name of Read Security Community
Level of Security	There are three levels available: (auth, priv), (auth, no priv) and (no auth, no priv)
Write Security Name	Input the name of Write Security Community
Level of Security	There are three levels available: (auth, priv), (auth, no priv) and (no auth, no priv)
SNMP Port	The port of SNMP, the default is 161

 **Note:**

- The settings of SNMP software should be the same as the settings you configure here;
- A reboot is required for the settings to take effect.

802.1x

The IEEE 802.1X standard is supported by the network cameras, and when the feature is enabled, the camera data is secured and user authentication is needed when connecting the camera to the network protected by the IEEE 802.1X.

Enable 802.1x:	<input checked="" type="checkbox"/>
Protocol:	EAP-MD5 ▾
Eapol Version:	1 ▾
User Name:	<input type="text"/>
Password:	<input type="text"/>
Confirm Password:	<input type="text"/>

Save

Bonjour

Bonjour is based on Apple's multicast DNS service. Bonjour devices can automatically broadcast their service information and listen to the service information of other devices.

If you don't know the camera information, you can use the Bonjour service on the same LAN to search for network camera devices and then to access the devices.

Enable Bonjour:	<input checked="" type="checkbox"/>
Bonjour Name:	MS-C2962-FPB-1CC316210991

Save

RTMP

Real-Time Messaging Protocol (RTMP) was initially a proprietary protocol for streaming audio, video and data over the Internet, between a Flash player and a server. RTMP is a TCP-based protocol which maintains persistent connections and allows low-latency communication. It can realize the function of live broadcast so that customers can log in to the camera wherever there is a network.

Enable RTMP:	<input checked="" type="checkbox"/>
Stream Type:	Secondary Stream ▼
Server Address:	rtmp://a.rtmp.youtube.com/

[Save](#)

For more information, please refer to ***Troubleshooting-How to Use RTMP for Live Broadcast***

 **Note:**

- For YouTube live broadcast, if you use a newly created account to live broadcast, you need to wait for 24hrs to activate the account for using live function.
- For RTMP, since G.711 is not available for YouTube, so you can only play video from Milesight network cameras with H.264 video coding and AAC audio coding on YouTube.
- Server Address in Network Camera RTMP interface needs to be filled with the format: rtmp://< Server URL >/< Stream key >, remember it needs '/' to connect between < Server URL > and < Stream key >.

More

Here you can set more functions, like Push Message Settings and ONVIF Settings.

Push Message Settings

Push Message Settings	
Enable Push Message:	<input checked="" type="checkbox"/>
Push Event Type:	Edit

When enabling the Push Message function, you can click [Edit](#) to choose the types of Events' message which will be pushed to M-sight Pro App as shown below:

Push Event Type	
<input checked="" type="checkbox"/> All	
<input checked="" type="checkbox"/> Motion Detection	<input checked="" type="checkbox"/> Region Entrance
<input checked="" type="checkbox"/> Region Exiting	<input checked="" type="checkbox"/> Advanced Motion Detection
<input checked="" type="checkbox"/> Tamper Detection	<input checked="" type="checkbox"/> Line Crossing
<input checked="" type="checkbox"/> Loitering	<input checked="" type="checkbox"/> Human Detection
<input checked="" type="checkbox"/> People Counting	<input checked="" type="checkbox"/> Object Left/Removed
<input checked="" type="checkbox"/> Face Detection	

Save

 **Note:** There must be Opened Alarm Push of corresponding cameras in M-sight Pro APP.

ONVIF Settings

Here you can choose whether to enable or disable camera ONVIF function. If camera ONVIF function is enabled, it can be searched out, added and connected by third-party software through ONVIF protocols. Generally, the default status of ONVIF function is enabled.

ONVIF Setting	
Enable ONVIF:	<input checked="" type="checkbox"/>

Save

5.4.5 Date&Time

Current System Time	
Date:	26/04/2020
Time:	14:49:33
Set the System Time	
Time Zone:	(UTC+08:00) China(Beijing, Hong Kong) ▼
Daylight Saving Time:	Disabled ▼
<input checked="" type="radio"/> NTP server	
Server Address:	192.168.14.101
NTP Sync:	<input checked="" type="checkbox"/> Interval: 1 day ▼
<input type="radio"/> Manual	
Time:	26/04/2020 14:48:34 
<input type="radio"/> Synchronize with computer time	
Date:	26/04/2020
Time:	14:49:35
<input type="button" value="Save"/>	

Current System Time

Current date&time of the system

Set the System Time

Table 22. Description of the buttons

Parameters	Function Introduction
Time Zone	Choose a time zone for your location
Daylight Saving time	Enable the daylight saving time
NTP server	Input the address of NTP server

Parameters	Function Introduction
NTP Sync	Regularly update your time according to the interval time
Manual	Set the system time manually
Synchronize with computer time	Synchronize the time with your computer

5.5 Advanced Settings

5.5.1 Storage

Before you start:

To configure record settings, please make sure that you have the network storage device within the network or the SD card inserted in your camera.

Choose the storage mode according to your needs.

Storage Management

SD Card:

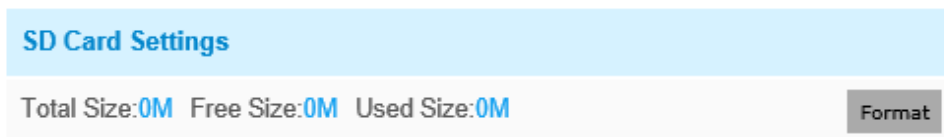

Note: Please insert SD card.

Table 23. Description of the buttons

Parameters	Function Introduction
Format	Format SD card, the files in SD card will be removed
Mount/UnMount	Mount/Dismount SD card

Parameters	Function Introduction
Delete	Enable cyclic storage, when the free disk space reach at a certain value, it will automatically delete the files at certain percentage according to your settings

NAS:

The network disk should be available within the network and properly configured to store the recorded files, etc.

NAS (Network-Attached Storage), connecting the storage devices to the existing network, provides data and files services.

NAS Settings

Server Address:

File Path:

Mounting Type:

Add

Table 24. Description of the buttons

Parameters	Function Introduction
Server Address	IP address of NAS server
File Path	Input the NAS file path, e.g. “\path”.
Mounting Type	NFS and SMB/CIFS are available. And you can set the user name and password to guarantee the security if SMB/CIFS is selected

 **Note:** Up to 5 NAS disks can be connected to the camera.

Record Settings

Storage Settings

Enable Recycle Storage:

Pre-record: 0 second ▼

Save

Schedule Settings

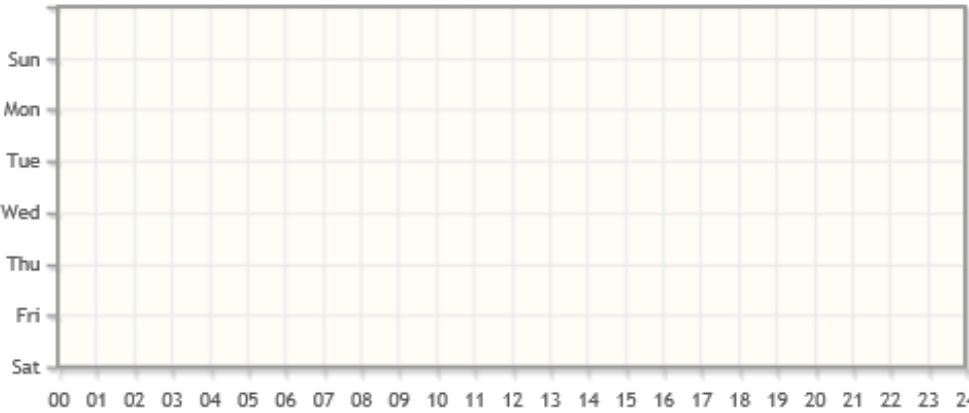

Edit

Table 25. Description of the buttons

Parameters	Function Introduction
Enable Recycle Storage	Enable/Disable Recycle Storage, if you enable this option, it will delete the files when the free disk space reach a certain value.
Pre-record	Reserve the record time before alarm, 0~10 sec
Schedule Settings	Click the Edit button to edit record schedule

Note: SD Card or NAS are available.

Snapshot Settings

Snapshot Settings	
Enable Timing Snapshot:	<input type="checkbox"/>
Interval:	<input type="text" value="1"/> <input type="text" value="hour"/>
Save Into Storage:	<input type="checkbox"/> (Please mount storage device.)
File Name:	<input type="text" value="Add Time Suffix"/>
Upload Via FTP:	<input type="checkbox"/>
Upload Via SMTP:	<input type="checkbox"/>

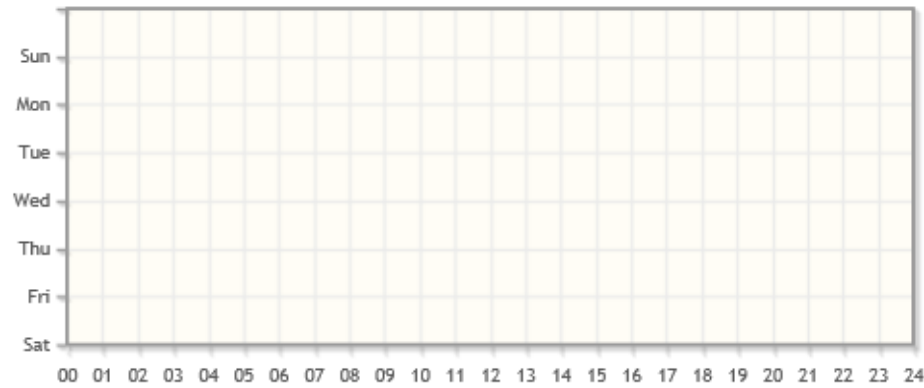

Save

Schedule Settings



Edit

Table 26. Description of the buttons

Parameters	Function Introduction
<p style="text-align: center;">Snapshot Settings</p>	<p>Enable Timing Snapshot: Check the checkbox to enable the Timing Snapshot function</p> <p>Interval: Set the snapshots interval, input the number and choose the unit(millisecond, second, minute, hour, day)</p> <p> Note: The interval must be between 1 and 604800.</p> <p>Save Into Storage: Save the snapshots into SD card or NAS, and choose the file name to add time suffix or overwrite the base file name.</p> <p>Save Into NAS: Save the snapshots into NAS, and choose the file name to add time suffix or overwrite the base file name</p> <p>Upload Via FTP: Upload the snapshots via FTP</p> <p>Upload Via SMTP: Upload the snapshots via SMTP</p> <p> Note: If you choose to add time suffix, every snapshot picture will be saved, but if you choose to overwrite the base file name, only one latest picture will be saved. When you choose add overwrite the base file name to SD Card or NAS, it will create a file named "Snapshot" to place the snapshot.</p>
<p style="text-align: center;">Schedule Settings</p>	<p>Click the Edit button to edit record schedule</p>

Explorer

Files will be seen on this page when they are configured to save into SD card or NAS. You can set time schedule every day for recording videos and save video files to your desired location.

 **Note:** Files are visible once SD card is inserted. Don't insert or pull out SD card when power on

Video files are arranged by date. Set file type and start/end time to search out files. Each day files will be displayed under the corresponding date, from here you can copy and delete files etc. You can visit the files in SD card by ftp, for example, ftp://username:password@192.168.5.190(user name and password are the same as the camera account and the IP followed is the IP of your device.).

Show entries Download

<input type="checkbox"/>	File Name	Start Time	End Time	Type	Size
Please mount storage device first!					

File Search

Main Type:

Sub Type:

Start Time:

End Time:

Showing 0 to 0 of 0 entries [First](#) [Previous](#) [Next](#) [Last](#)

5.5.2 Security

User

Manage Privilege

Allow Anonymous Viewing:

Security Question

Security Question:

Account Management

ID	User Name	Privilege
1	admin	Administrator

Admin Password:

User Level:

User Name:

Password:

Confirm:

User Privilege

<input checked="" type="checkbox"/> All	
<input checked="" type="checkbox"/> Live Video	<input checked="" type="checkbox"/> Playback
<input checked="" type="checkbox"/> Local Settings	<input checked="" type="checkbox"/> Video Settings
<input checked="" type="checkbox"/> Audio Settings	<input checked="" type="checkbox"/> Image Settings
<input checked="" type="checkbox"/> Network Settings	<input checked="" type="checkbox"/> RTSP Access
<input checked="" type="checkbox"/> Date & Time	<input checked="" type="checkbox"/> Event Settings
<input checked="" type="checkbox"/> Storage Settings	<input checked="" type="checkbox"/> Storage Format
<input checked="" type="checkbox"/> Security Settings	<input checked="" type="checkbox"/> SIP Settings
<input checked="" type="checkbox"/> Logs	<input checked="" type="checkbox"/> System
<input checked="" type="checkbox"/> Maintenance	

Note: You can only add 20 users

Save

Table 27. Description of the buttons

Parameters	Function Introduction
Manage Privilege	Allow anonymous viewing: Check the checkbox to enable visit from whom doesn't have account of the device

Parameters	Function Introduction
<p style="text-align: center;">Security Question</p>	<p>Click "Edit" button to set three security questions for your camera. In case that you forget the password, you can click "Forget Password" button on login page to reset the password by answering three security questions correctly.</p> <div style="border: 1px solid #ccc; padding: 10px; margin: 10px 0;"> <p style="text-align: center; color: #0070C0; font-weight: bold;">Security Question Settings</p> <p>Admin Password: <input type="text"/></p> <p>Security Question1: <input type="text" value="What's your father's name?"/> ▼</p> <p>Answer1: <input type="text"/></p> <p>Security Question2: <input type="text" value="What's your father's name?"/> ▼</p> <p>Answer2: <input type="text"/></p> <p>Security Question3: <input type="text" value="What's your father's name?"/> ▼</p> <p>Answer3: <input type="text"/></p> <p style="text-align: center; margin-top: 10px;"><input type="button" value="Save"/></p> </div> <p>There are twelve default questions below, you can also customize the security questions.</p> <div style="border: 1px solid black; padding: 5px; margin-top: 10px;"> <p style="background-color: #0070C0; color: white; padding: 2px;">What's your father's name?</p> <p>What's your favorite sport?</p> <p>What's your mother's name?</p> <p>What's your mobile number?</p> <p>What's your first pet's name?</p> <p>What's your favorite book?</p> <p>What's your favorite game?</p> <p>What's your favorite food?</p> <p>What's your lucky number?</p> <p>What's your favorite color?</p> <p>What's your best friend's name?</p> <p>Where did you go on your first trip?</p> <p>Customized Question</p> </div>

Parameters	Function Introduction
Account Management	<p>Click “Add” button, it will display Account Management page. You can add an account to the camera by entering Admin Password, User Level, User Name, New Password, Confirm, and edit user privilege by clicking <input type="checkbox"/>. The added account will be displayed in the account list.</p> <p>Admin Password: You can add an account only after you enter the correct admin password.</p> <p>User Level: Set the privilege for the account.</p> <p>User Name: Input user name for creating an account.</p> <p>Password: Input password for the account.</p> <p>Confirm: Confirm the password.</p> <p>You can edit and delete the account in the account list under the admin account. For the default admin account, you can only change the password, and it cannot be deleted.</p>

 **Note:**

- Support up to 20 users, including a default user and 19 custom added users.
- The operator privilege is all checked by default.
- For camera firmware version 4X.7.0.69 or above, it removes the default admin password and allows to set a password when logging in for the first time. It also supports set-up of the security questions for the devices. Users can reset the password by answering the correct security questions in case of forgetting the password, which is more convenient for users.

Online User

Here real-time status of user logging in camera will be shown.

Online User				
Refresh				
No.	User Name	User Level	IP Address	User Login Time
1	admin	Administrator	192.168.7.110	2021-02-20 10:12:29
2	admin	Administrator	192.168.7.79	2021-02-20 09:16:06
3	admin	Administrator	192.168.7.25	2021-02-19 17:12:02

Table 28. Description of the buttons

Parameters	Function Introduction
Refresh	Click to get latest status of user accessing to camera.
No.	Record serial number of user logging in camera.  Note: <ul style="list-style-type: none"> • There are at most 30 records shown at the list. • There is only one record if the same user logging on camera by the same IP address.
User Name	Name of user logging in camera.
User Level	Level of user logging in camera.
IP Address	Device IP address where user logging in camera web located.
User Login Time	Camera system time of user logging in camera.

Access List

General Settings

Maximum Number of Concurrent Streaming:

IP Access List

Rule:

IP Address:

Enable Access List Filtering:

Filter Type: Allow Deny

Table 29. Description of the buttons

Parameters	Function Introduction
General Settings	Maximum number of concurrent streaming: Select the maximum number of concurrent streaming. Options include No Limit, 1~10
IP access list	Rule: Single, Network and Range are available IP address: Input the address to get the access to the device
Enable access list filtering	Able to access or restrict access for some IP address
Filter type	Access or restrict access

Security Service

SSH Settings

Enable SSH:	<input checked="" type="checkbox"/>
SSH Port:	<input style="width: 80%;" type="text" value="6022"/>

Table 30. Description of the buttons

Parameters	Function Introduction
SSH Settings	Secure Shell (SSH) has many functions: it can replace Telnet and also provides a secure channel for FTP, POP, even for PPP.

Watermark

Watermark Settings

Enable Watermark:	<input checked="" type="checkbox"/>
Watermark String:	<input style="width: 80%;" type="text" value="IP CAMERA"/>

Watermarking is an effective method to protect information security, realizing anti-counterfeiting traceability and copyright protection. Milesight network cameras supports Watermark function to ensure information security.

About

Open Source Software Licenses

[View Licenses](#)

User can view some open source software licenses about the camera by clicking the View Licenses button.

5.5.3 SIP

The Session Initiation Protocol(SIP) is a signaling communications protocol, widely used for controlling multimedia communication sessions such as voice and video calls over Internet Protocol (IP) networks. This page allows user to configure SIP related parameters. Milesight network cameras can be configured as SIP endpoint to call out when alarm triggered; or allow permitted number to call in to check the video if the video IP phone is used. To use this function, the settings in SIP page must be configured properly. There are two ways to get video through SIP, one is to dial the IP address directly, the other is account registration mode. the details are as follows:

Method 1: IP Direct mode

Dial on the camera's IP address directly through SIP phone, so you can see the video.

 **Note:** SIP phone and the camera should in the same network segment.

Method2: Account registration mode

- Before using the SIP, you need to register an account for the camera from the SIP server;
- Register another user account for the SIP device from the same SIP server;
- Call the camera User ID from the SIP device, you will get the video on the SIP device.

SIP Settings

Unregistered	
Enable:	<input type="checkbox"/>
Register Mode:	Enable ▼
User ID:	500
User Name:	sipclient
Password:	••••••••
Server Address:	192.168.5.101
Server Port:	5060
Connection Protocol:	UDP ▼
Video Stream:	Secondary Stream ▼
Max Call Duration:	1800 s (0 means no limitation.)

Note: SIP supports Direct IP call.

Save

Table 31. Description of the buttons

Parameters	Function Introduction
Unregistered/Registered	SIP registration status. Display "Unregistered" or "Registered"
Enable	Start or stop using SIP
Register Mode	Choose to use Enable mode or Disable mode. Enable mode means to use SIP with register account. Disable mode refers to use SIP without register account, just use the IP address to call.
User ID	SIP ID
User Name	SIP account name
Password	SIP account password

Parameters	Function Introduction
Server Address	Server IP address
Server Port	Server port
Connection Protocol	UDP/TCP
Video Stream	Choose the video stream
Max Call Duration	The max call duration when use SIP

 **Note:** SIP supports Directly IP call.

Alarm Phone List

Phone Type:	<input type="text" value="Phone Number"/>
To Phone Number:	<input type="text"/>
Remark Name:	<input type="text"/>
Duration:	From <input type="text" value="00"/> : <input type="text" value="00"/> To <input type="text" value="24"/> : <input type="text" value="00"/>

Table 32. Description of the buttons

Parameters	Function Introduction
Phone Type	Phone Number(Call by phone number) & Direct IP Call(Check to accept peer to peer IP call).
To Phone Number/IP Address	Call by phone number or IP address.
Remark Name	Display name.
Duration	The time schedule to use SIP.

White List

Phone Type:	Phone Number ▼
Phone Number:	<input type="text"/>
Add	
Enable White List Number Filter:	<input type="checkbox"/>
Save	

Table 33. Description of the buttons

Parameters	Function Introduction
Phone Type	Phone Number(Call by phone number) & Direct IP Call
Phone Number/IP Address	Including the phone number or IP address on the white list
Enable White List Number Filter	When enabled, only the designated phone number or IP address can visit

5.5.4 PTZ

PTZ Settings provides you to configure the functions and parameters about Pan/Tilt/Zoom.

PTZ parameters are mainly include the Basic parameters, Auto Home, PTZ Limits, Initial Position(Mini PTZ Bullet), Privacy Mask, Scheduled Tasks, Auto Tracking, Config Clear, RS485(Speed Dome).

Basic

PTZ OSD	
Zoom Status:	5 seconds ▼
Pan & Tilt Status:	5 seconds ▼
Preset Status:	5 seconds ▼
Patrol Status:	Always Open ▼
Pattern Status:	Always Open ▼
Auto Scan Status:	Always Open ▼
Preset	
Preset Freezing:	<input type="checkbox"/>
Speed	
Preset Speed:	5 ▼
Manual Speed:	Medium ▼
Patrol	
Patrol Recovering:	<input type="checkbox"/>
Patrol Recovery Time(5-720s):	10 s
Focus	
Focus Mode:	Semi-Auto ▼
Minimum Focus Distance:	1 meter ▼
Power Off Memory	
Set Resume Time:	Disable ▼
Dehumidifying	
Fan Working Mode:	General ▼

[Save](#)

Table 34. Description of the buttons

Parameters	Function Introduction
PTZ OSD	Configure the OSD parameter, you can set the Zoom status OSD , Pan&Tilt Status , Preset Status with Always Close/Always Open/2s/5s/10s, and Patrol Status , Pattern Status , Auto Scan Status with Always Open/ Always Close.
Preset	If you enabled Preset Freezing, the live view of preset position will be showed directly instead of showing both the moving path to the position and the live view. It can also reduce the use of bandwidth in the digital network system.
Speed	Preset Speed: It determines the speed of calling presets. Level 1~10 are available.
	Manual Speed: it only for Speed Dome, and it determines the PTZ speed of Manually control. Low/ Medium/ High are available.
	Scan Speed: it is only for Speed Dome, and it determines the speed of Auto Scan. Level 1~10 are available.
Patrol	Patrol Recovering: Click to enable Patrol Recovering.
	Patrol Recovery Time: Set time for Patrol Recovering, which is between 5 to 720 seconds.
Focus	Focus Mode: Three focus modes are available: Auto/ Semi-Auto/ Manual.
	Minimum Focus Distance: Set the minimum focus distance to adjust the step length of each focus. 1 meter, 1.5 meters, 3 meters, 6 meters, 10 meters and 20 meters are available. The default minimum focus distance is 1 meter.
Power Off Memory	If the camera stop working for a longer time than predefined, the position of it will be recorded. And it will resume to the position after going back to the normal work from power off. You can set the resume time to 30 seconds, 60 seconds, 300 seconds or 600 seconds to record its position.
Dehumidifying	<p>Fan Working Mode: Three fan working modes are available: General/ Enhancement/ Constant.</p> <p>General: The fans are turned on from 4am to 7am and 5pm to 8pm every day.</p> <p>Enhancement: The fans are turned on from 5pm to 7am every day.</p> <p>Constant: The fans work 24 hours a day.</p>

Auto Home



Enable:	<input checked="" type="checkbox"/>
Latency Time(5-720s):	<input type="text" value="5"/> s
Auto Home Mode:	<input type="text" value="Preset"/> ▼
Auto Home Mode Number:	<input type="text" value="Current Location"/> ▼ <input type="button" value="Call"/>

Save

Auto Home allows the PTZ camera to return to a predefined Home Position automatically after a period of latency time. Check the checkbox to enable the Auto Home mode.

Table 35. Description of the buttons

Parameters	Function Introduction
Latency Time	Set a latency time to trigger Auto Home mode, 5-720s.
Auto Home Mode	Preset: A preset point will take effect when triggering the Auto Home.
Auto Home Mode Number	Select a predefined preset in the list, press "Call" to check the location. Also support to select current location.

PTZ Limit

The PTZ camera can be programmed to move within the configurable PTZ Limits(Left/Right).

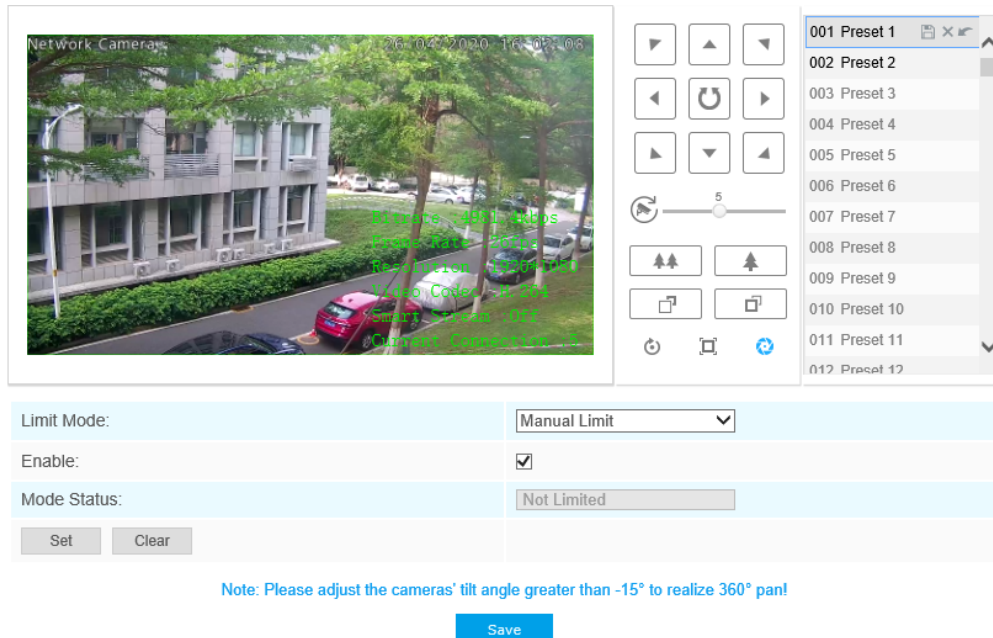

Step1: Check the checkbox to enable the PTZ Limit function.

Step2: Choose the limit mode as Manual limit or scanning limit.

- Manual Limit:

When Manual limit stops are set, you can operate the PTZ control panel manually only in the limited surveillance area.

- Scan Limit:

When Scan limit stops are set, the auto scan is performed only in the limited surveillance area.

Step3: Click the PTZ controller buttons to set the left/right limit stops; you can also call the defined presets and set them as the limits of the PTZ camera.

Step4: Click **Set** to save the limits or **Clear** to clear the limits.

Initial Position

You can configure the Initial Position for PTZ cameras as a zero point.

Step1: Click the PTZ control buttons as the Initial Position of the Mini PTZ bullet, you can also call a defined preset and set it as the Initial Position.

Step2: Click Set to save the position as the Initial Position.

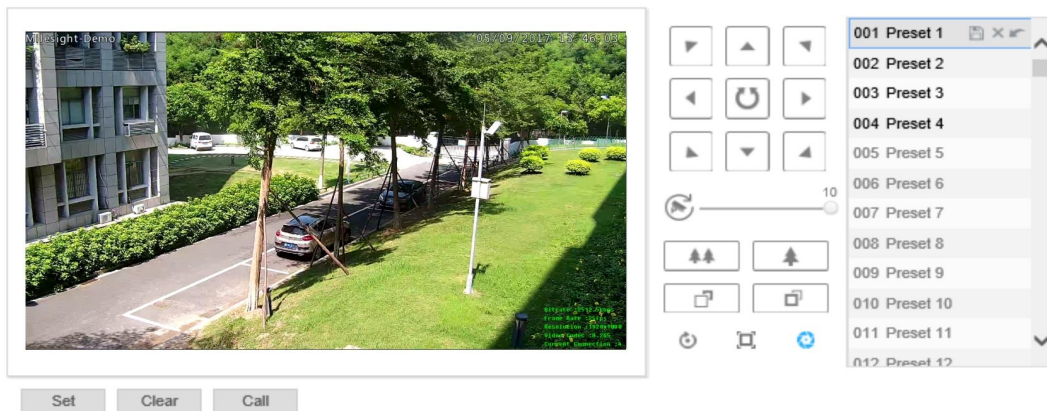
**Table 36. Description of the buttons**

Parameters	Function Introduction
Set	Click to set the current position as a Initial Position
Clear	Clear the Initial Position to default settings.
Call	Click to call the Initial Position.

Privacy Mask

Privacy mask enables to cover certain areas on the live video to prevent certain spots in the surveillance area from being viewed and recorded. The mask area does not move as the lens moves. You can set 28 mask areas at most, which include 24 mask areas and 4 mosaic areas.

Privacy Mask

You can set 24 mask areas at most.

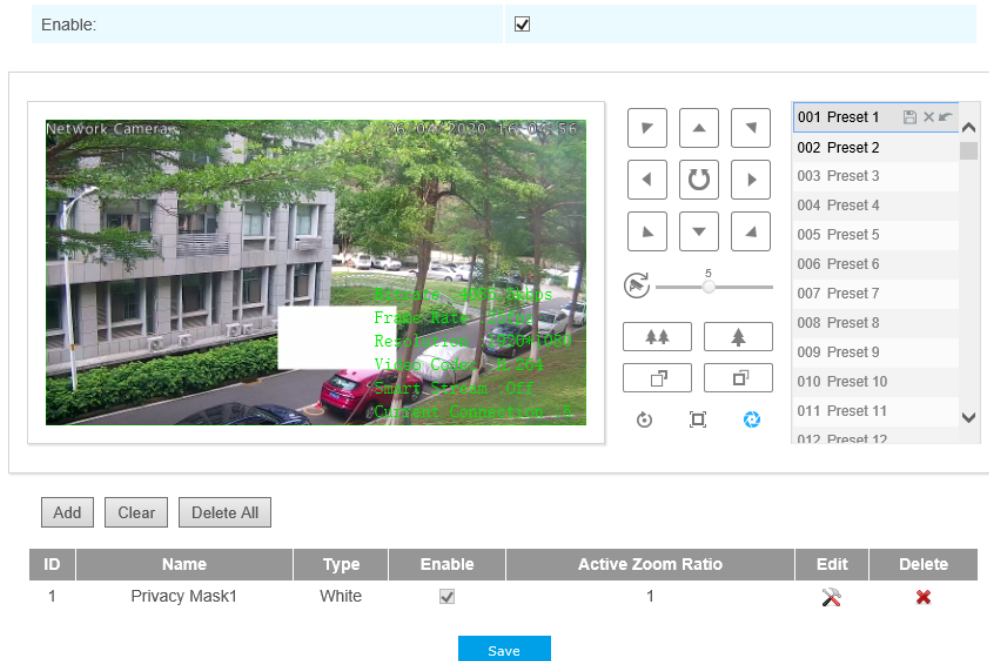

Table 37. Description of the buttons

Parameters	Function Introduction
Enable	Check the checkbox to enable the Privacy Mask function
Add	Add the current drawing area as Privacy Mask
Clear	Clear the current drawing area
Clear All	Clear all areas you drew before
Name	Support to customize the name of Privacy Mask
Type	Select the color for the privacy areas, there are eight colors available: White, Black, Blue, Yellow, Green, Brown, Red, Violet
Active Zoom Ratio	Set the value of Active Zoom Ratio according to your need, and then the mask will only appear when the zoom ratio is greater than the predefined value

Mosaic type of Privacy Mask (Optional)

You can set 28 mask areas at most, which includes 24 mask areas and 4 mosaic areas. The mosaic type can maintain the continuity of the picture and improve the visual effect.

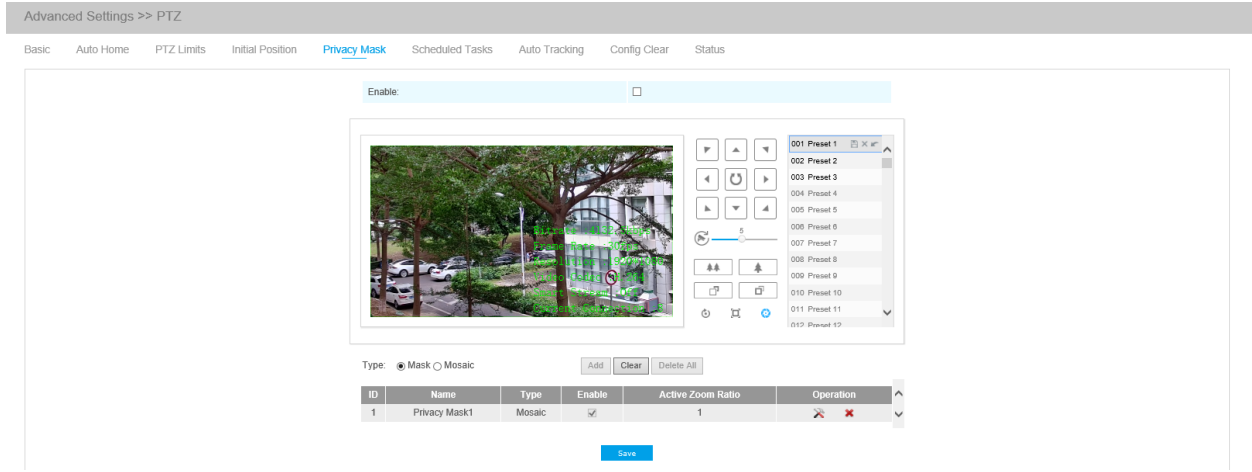

Table 38. Description of the buttons

Parameters	Function Introduction	
Type	Select the type to use for the privacy areas, there are two types available: Mask and Mosaic	
Operation		Change the color of Mask area, there are eight colors available: White, Black, Blue, Yellow, Green, Brown, Red and Violet
		Delete the privacy mask area

Schedule Tasks

You can configure the PTZ camera to perform a certain action automatically in a user-defined time period.

Step1: Enter the Scheduled Task Settings interface:

Enable Scheduled Tasks:

Schedule Settings

Close

Sun	0	2	4	6	8	10	12	14	16	18	20	22	24
Mon	0	2	4	6	8	10	12	14	16	18	20	22	24
Tue	0	2	4	6	8	10	12	14	16	18	20	22	24
Wed	0	2	4	6	8	10	12	14	16	18	20	22	24
Thu	0	2	4	6	8	10	12	14	16	18	20	22	24
Fri	0	2	4	6	8	10	12	14	16	18	20	22	24
Sat	0	2	4	6	8	10	12	14	16	18	20	22	24

Tasks Interference Settings

Tasks Recovery Time(5-720s): s

Close
 Auto Scan
 Preset
 Patrol
 Pattern
 Check

Step2: Check the checkbox to Enable Scheduled Task.

Step3: Set the schedule and task details.

Step4: Set the Task Recovery Time(from 5 to 720 seconds). You can set the time(a period of inactivity) before the PTZ camera starts the schedule and task details.

Step5: Click button to save all the configurations.

Note:

- The time of each task cannot be overlapped. Up to 10 tasks can be configured for each day.
- The Scheduled Tasks function is prior to Auto Home function. When these two functions are set at the same time, only the Scheduled Tasks function takes effect.

- You can click button to select or close all schedule of different kinds of tasks.

Auto Tracking

PTZ series cameras support to track the moving objects automatically after you configure this function.

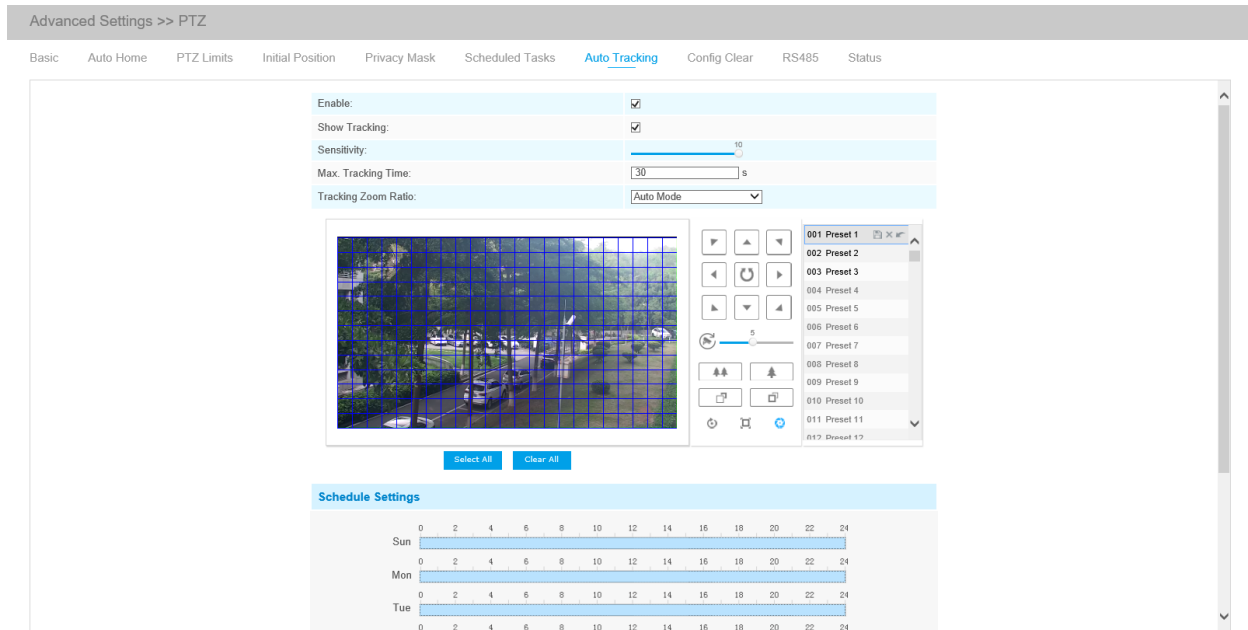

Step1: Check the checkbox to enable Auto Tracking;

Step2: Enable “Show Tracking” to show tracking in Auto Tracking function.

Step3: Set detecting sensitivity;

Step4: Set Max. Tracking Time which must be between 5~300s. The camera will stop tracking when the tracking time is used up.

Step5: Set Tracking Zoom Ratio including Auto Mode and Customize. The camera will automatically adjust tracking zoom ratio when Auto Mode is chosen. When Customize is chosen, user needs to set the tracking zoom ratio first by adjusting zoom button, then camera will automatically track the moving objects according to customized tracking zoom ratio and the object's proportion in the picture at the moment. At the same time, the object will always keep the same proportion in the picture during the tracking process.

Step6: Set Auto Tracking schedule.

Step7: Draw the screen to set the detection region.

Step8: Set Auto Tracking Schedule.

 **Note:** Please turn off Auto Home before using Auto Tracking.

Config Clear

Clear All:	<input type="checkbox"/>
Clear All Presets:	<input type="checkbox"/>
Clear All Patrols:	<input type="checkbox"/>
Clear All Patterns:	<input type="checkbox"/>
Clear All Auto Homes:	<input type="checkbox"/>
Clear All PTZ Limits:	<input type="checkbox"/>
Clear Initial Position:	<input type="checkbox"/>
Clear All Privacy Masks:	<input type="checkbox"/>
Clear All Scheduled Tasks:	<input type="checkbox"/>

Save

Here you can clear PTZ configurations, including all PTZ configurations, Presets, Patrols, Patterns, Auto Homes, PTZ Limits , Initial Position(Mini PTZ Bullet), Privacy Masks and Scheduled Tasks.

RS485

Protocol:	<input checked="" type="radio"/> Pelco-D <input type="radio"/> Pelco-P
Baudrate:	9600 ▼
Data Bit:	8 ▼
Stop Bit:	1 ▼
Parity:	None ▼
Flow Control:	None ▼
PTZ Address:	1

Save

Here you can clear configure RS485 serial port to control the PTZ of Speed Dome. Protocol, Baudrate, Data Bit, Stop Bit, Parity, Flow Control, PTZ Address should be exactly the same as those of the control device.

 **Note:** This function is only for Speed Dome.

Logs

The logs contain the information about the time and IP that has accessed the camera through web.

Show entries

Time	Main Type	Sub Type	Param	User	IP	Detail	Log Search
2017-09-04 13:35:41	Operation	RTSP Session Stop	-	-	192.168.8.50	stop one session.	Main Type: <input type="text" value="All Types"/> Sub Type: <input type="text" value="All Types"/> Start Time: <input type="text" value="2017-09-04 00:00:00"/> End Time: <input type="text" value="2017-09-04 13:30:26"/> <input type="button" value="Search"/> <input type="button" value="Log Export"/> Save Period: <input type="text" value="Permanent"/> <input type="button" value="Save"/>
2017-09-04 13:29:18	Operation	RTSP Session Start	-	-	192.168.8.50	start one session.	
2017-09-04 13:29:14	Operation	RTSP Session Stop	-	-	192.168.8.50	stop one session.	
2017-09-04 13:28:54	Operation	RTSP Session Start	-	-	192.168.8.50	start one session.	
2017-09-04 13:28:53	Operation	Login Remotely	-	admin	192.168.8.50	-	
2017-09-04 05:50:00	Information	IR-CUT On	-	-	-	-	
2017-09-03 18:35:25	Information	IR-CUT Off	-	-	-	-	
2017-09-03 05:43:58	Information	IR-CUT On	-	-	-	-	
2017-09-02 18:37:57	Information	IR-CUT Off	-	-	-	-	
2017-09-02 05:41:22	Information	IR-CUT On	-	-	-	-	
2017-09-01 18:43:37	Information	IR-CUT Off	-	-	-	-	
2017-09-01 17:00:57	Operation	RTSP Session Stop	-	-	192.168.8.50	stop one session.	
2017-09-01 16:55:24	Event	Motion Detection Stop	-	-	-	-	
2017-09-01 16:55:19	Operation	RTSP Session Start	-	-	192.168.8.50	start one session.	
2017-09-01 16:55:17	Operation	RTSP Session Stop	-	-	192.168.8.50	stop one session.	
Motion Detection							
Showing 1 to 30 of 1,221 entries							
<input type="button" value="First"/> <input type="button" value="Previous"/> <input type="text" value="1"/> <input type="button" value="2"/> <input type="button" value="3"/> <input type="button" value="4"/> <input type="button" value="5"/> <input type="button" value="..."/> <input type="button" value="41"/> <input type="button" value="Next"/> <input type="button" value="Last"/> <input type="text" value=""/> <input type="button" value="Go"/>							

Table 39. Description of the buttons

Parameters	Function Introduction
Main Type	There are five main log types: All Type, Event, Operation, Information, Exception, Event
Sub Type	On the premise of main type has been selected, select the sub type to narrow the range of logs
Start Time	The time log starts
End Time	The time log ends
Log Export	Export the logs
Save Period	Set the period of log saving, there are eight options to choose: Permanent and 30/60/120/180/240/300/360 Days
Go	Input the number of logs' page

5.6 Event

5.6.1 Basic Event

Motion Detection

Step1: Check the checkbox to enable the motion detection;

Step2: Select the detection mode;

Step3: Set motion region;

Enable Motion Detection:	<input type="checkbox"/>
Detection Mode:	Normal Mode
Sensitivity:	5
Onvif Motion ActiveCells Settings:	Normal
Enable Motion Analysis:	<input type="checkbox"/>

Set Motion Region

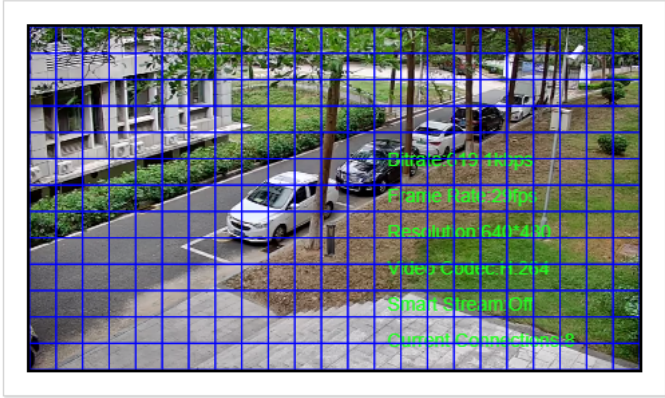

Select All Clear All

Note: Please draw the screen for setting!

Table 40. Description of the buttons

Parameters	Function Introduction
Enable Motion Detection	Check the checkbox to enable Motion Detection function

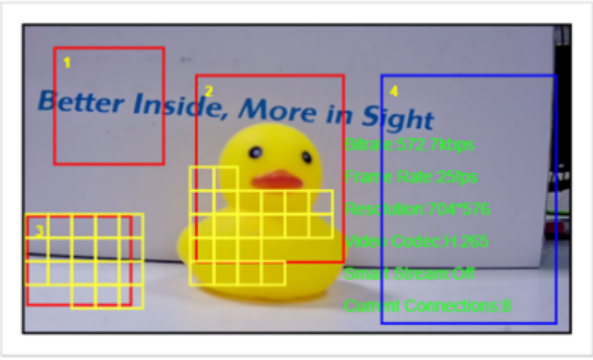
Parameters	Function Introduction
Detection Mode	Normal Mode and Advanced Mode are available for the option. When Advanced Mode is selected, users can configure up to 4 detection regions and sensitivity for each detection region.
Onvif Motion ActiveCells Settings	Normal and Compatible are available for the option. If the setting of motion region of the third-party software is different from ours, please set this option to Compatible
Enable Motion Analysis	<p>When Motion Analysis is enabled, the moving region will turn yellow so that the user can know exactly where the motion occurred.</p> <p> Note: Only support when HTTP is selected in Live View.</p> 
Select All	Click the button, the motion in the area will be detected
Clear All	Click the button, the area drawn before will be removed
Sensitivity	Sensitivity level, 1~10

Step4: Set motion detection schedule;

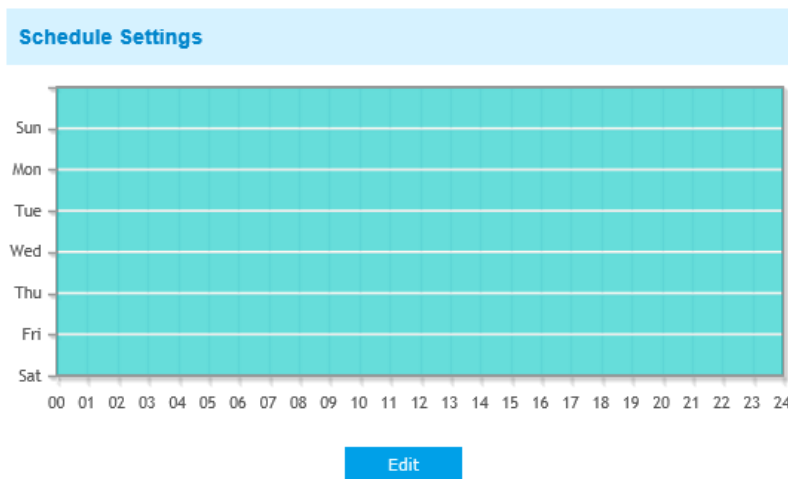

Step5: Set alarm action;

Alarm Action	
Save Into Storage:	<input type="checkbox"/> File Format: Record <input type="button" value="v"/> (Please mount storage device.)
Upload Via FTP:	<input type="checkbox"/> File Format: Record <input type="button" value="v"/>
Upload Via Email:	<input type="checkbox"/> File Format: Snapshot <input type="button" value="v"/> (Please enable the Email.)
External Output:	<input type="checkbox"/> (Please configure the External Output Action Time.)
Play Audio:	<input type="checkbox"/> (Please enable the Audio Speaker.)
Alarm to SIP Phone:	<input type="checkbox"/> (Please open the SIP.)
HTTP Notification:	<input type="checkbox"/>
White LED:	<input type="checkbox"/>
PTZ Motion:	<input checked="" type="checkbox"/>

Table 41. Description of the buttons

Parameters	Function Introduction
Save Into Storage	Save alarm recording files into SD Card or NAS
Upload Via FTP	Upload the recording files via FTP
Upload Via SMTP	Upload the files via SMTP
External Output	If the camera equips with External Output, you can enable the action after configuring the trigger duration
Play Audio	If the camera equips with Speaker, you can enable the action after configuring the audio speaker
Play Buzzer	If the camera equips with Buzzer, you can check the checkbox to enable the function.
Alarm to SIP Phone	Support to call the SIP phone after enable the SIP function.
HTTP Notification	Support to pop up the alarm news to specified HTTP URL.  Note: <ul style="list-style-type: none"> • Three HTTP notifications at most can be added to the same event. • HTTP Notification supports Basic & Digest authentication

Parameters	Function Introduction
White LED	When the alarm triggered, White LED will turn on to warning the detected objects (Only for Mini PTZ Bullet).
PTZ Motion	When the motion alarm triggered, PTZ Motion allows the camera move the lens to the motion triggered position and zoom in.
Call Preset/ Call Patrol/Call Pattern (only for External Input)	When the motion alarm triggered, the specified preset/patrol/pattern can be called.

 **Note:** The **HTTP notification** function is just one way for camera to send messages to VMS Software. And it's the VMS that defines what the messages mean and decides what to do after receiving this kind of messages. So, we can use the **HTTP Notification** function of our cameras only if the VMS supports this kind of message format.

Here will take the Digifort as an example to introduce the **HTTP Notification** function.

The following are the detail steps of setting for HTTP Notification in Digifort VMS and our cameras.

Step1: Enable Alarm, set Motion Region and detection Schedule;

Step2: Check the HTTP Notification as Alarm Action, and fill the fields. Then save the alarm setting. You can add up to three HTTP notifications to the same event;

HTTP Notification:	<input checked="" type="checkbox"/>
HTTP Notification URL:	URL 1 
Enable:	<input checked="" type="checkbox"/>
Trigger Interval:	5 (0-900) s
URL:	192.168.8.75:8601/Interface/Cameras/MotionDetection/Notify?Camera=annie
User Name:	admin
Password:	••••••••

HTTP User Name: admin (the user name of your camera)

HTTP Password: ms1234 (the password of your camera)

HTTP Notification URL:

<http://IP:8601/Interface/Cameras/MotionDetection/Notify?Camera=CameraName>

IP refers to the PC's IP where the Digifort installed.

8601 is the port for Motion signal in Digifort.

CameraName is the camera name you set in Digifort VMS, like the picture shown below.

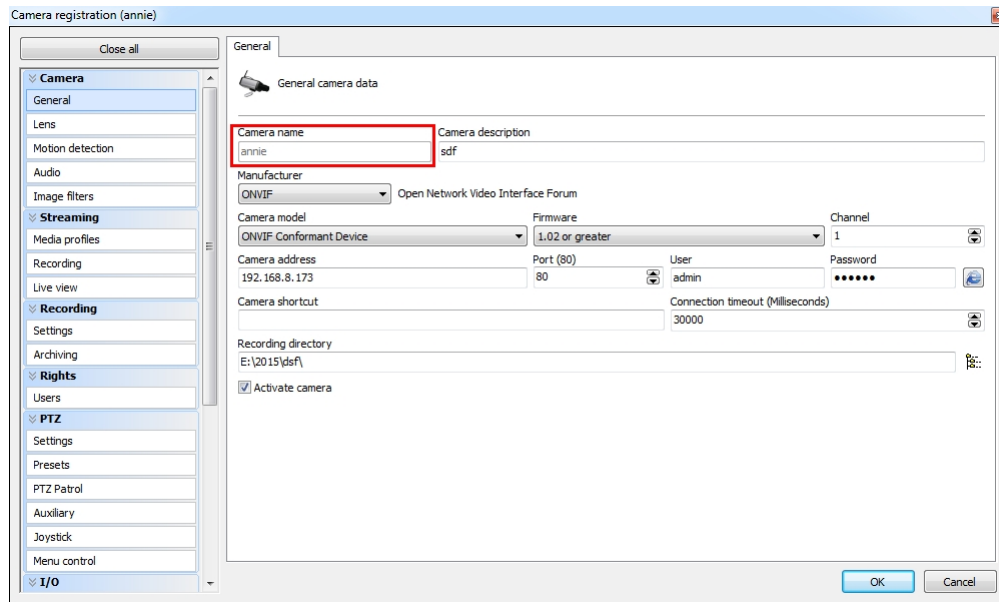

Example:

<http://192.168.8.75:8601/Interface/Cameras/MotionDetection/Notify?Camera=annie>,

this URL format is exactly supported by Digifort VMS, so we can set as above to our cameras and get it work well.

Step3: choose use motion detection by external notification;

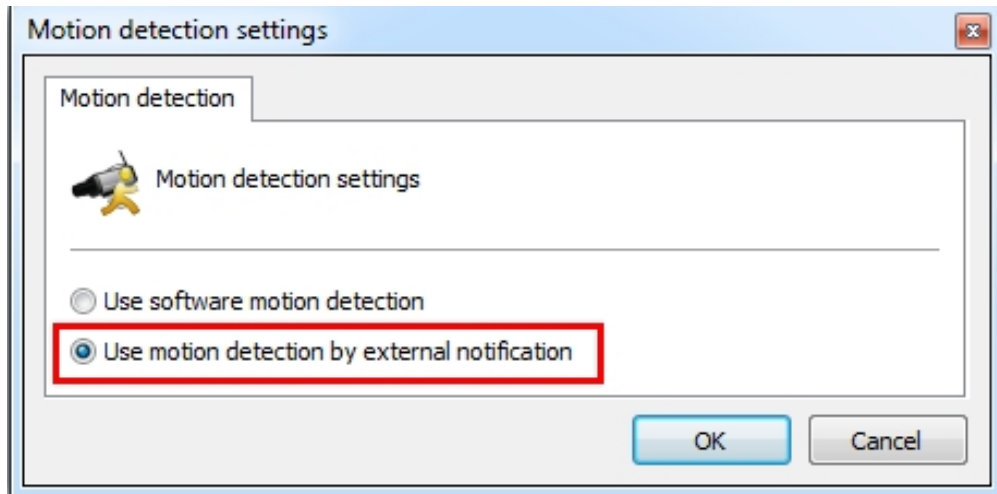

Step4: If successful, you can see the device icon turns yellow in the Surveillance when the camera is under Motion Detection Alarm;

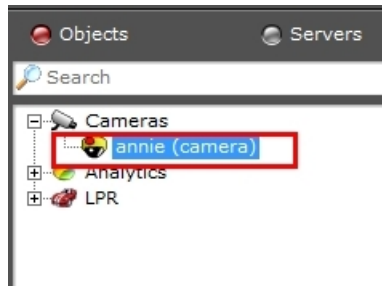

So, it's the VMS Software which decides whether we can use this function successfully.

Step5: Set alarm settings.

Alarm Setting

Record Video Sections: ▼

Snapshot: ▼

Snapshot Interval: ▼

Email Triggered Interval: ▼

External Output Action Time: ▼

Audio Action Settings:

Play Audio Interval: ▼

Table 42. Description of the buttons

Parameters	Function Introduction
Record Video Sections	Six different periods are available(5, 10, 15, 20, 25, 30 sec)
Snapshot	The number of snapshot, 1~5
Snapshot Interval	This cannot be edited unless you choose more than 1 to Snapshot
External Output Action Time	Length of time an alarm lasts, this cannot be edited unless you enable the External Output on the Alarm Action firstly.
Audio Action Settings	Set the audio schedule to trigger different audio files and action times in different time, which is corresponded to alarm action.
Play Audio Interval	Auto/ 10 seconds/ 30 seconds/ 1 minute/ 5 minutes/ 10 minutes are available.
White LED Flash Mode	Twinkle: The White LED will continuous flashing before recovered; Always: The White LED will always open before recovered.

Parameters	Function Introduction
White LED Flash Time	The duration of flash. Twinkle from 1 second to 10 seconds; Always from 1 second to 60 seconds.
Proportional Zoom Times	Support to zoom proportionally when PTZ Motion is triggered.
PTZ Motion Recovery Time	The duration of one alarm. It must be longer than flash time.

 **Note:**

- Recovery time should not be less than flash time.
- You can customize the schedule of Audio Action.

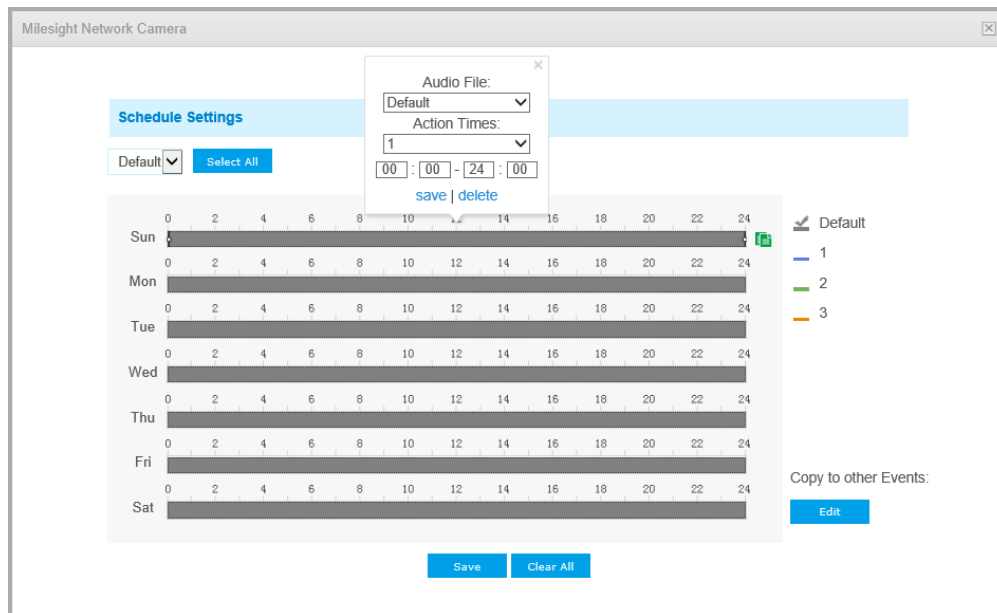

Audio Alarm

Enable the Audio before using Audio Alarm function.

Enable Audio Alarm:	<input type="checkbox"/>
Alarm Threshold:	<input type="range" value="25"/>
Audio Sample Value:	0 

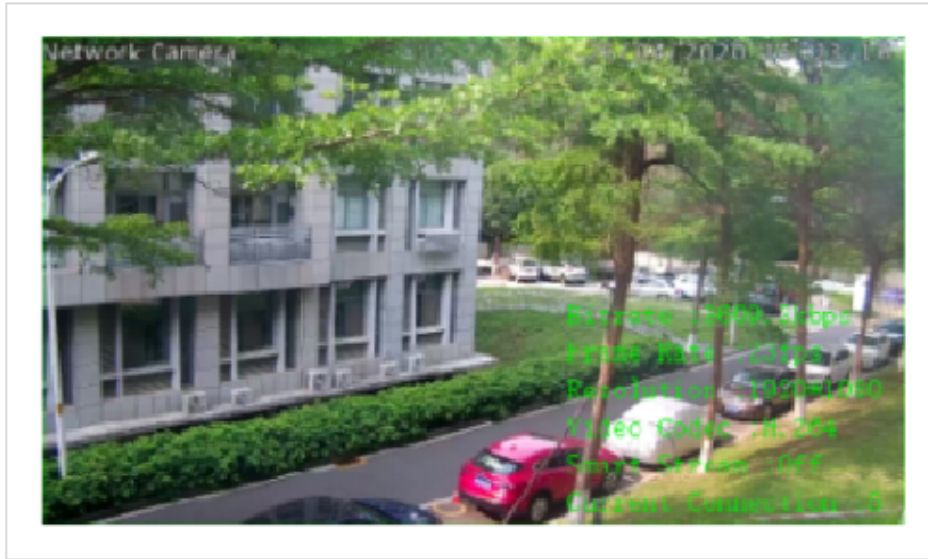

Schedule Settings

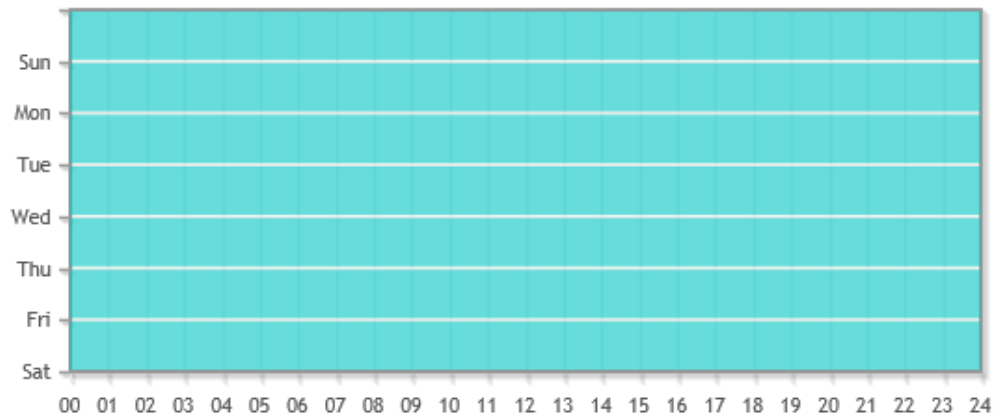

Edit

Alarm Action	
Save Into Storage:	<input type="checkbox"/> File Format: <input type="text" value="Record"/> <input type="button" value="v"/> (Please mount storage device.)
Upload Via FTP:	<input type="checkbox"/> File Format: <input type="text" value="Record"/> <input type="button" value="v"/>
Upload Via Email:	<input type="checkbox"/> File Format: <input type="text" value="Snapshot"/> <input type="button" value="v"/> (Please enable the Email.)
External Output:	<input type="checkbox"/> (Please configure the External Output Action Time.)
Play Audio:	<input type="checkbox"/> (Please enable the Audio Speaker.)
Alarm to SIP Phone:	<input type="checkbox"/> (Please open the SIP.)
HTTP Notification:	<input type="checkbox"/>
Alarm Setting	
Record Video Sections:	<input type="text" value="5 seconds"/> <input type="button" value="v"/>
Snapshot:	<input type="text" value="3"/> <input type="button" value="v"/>
Snapshot Interval:	<input type="text" value="1"/> <input type="text" value="second"/> <input type="button" value="v"/>
Email Triggered Interval:	<input type="text" value="Auto"/> <input type="button" value="v"/>
External Output Action Time:	<input type="text" value="30 seconds"/> <input type="button" value="v"/>
Audio Action Settings:	<input type="button" value="Edit"/>
Play Audio Interval:	<input type="text" value="Auto"/> <input type="button" value="v"/>

Refer to the table in Motion Detection chapter for the meanings of the items, here will not repeat again.

External Input

Enable External Input:

Schedule Settings

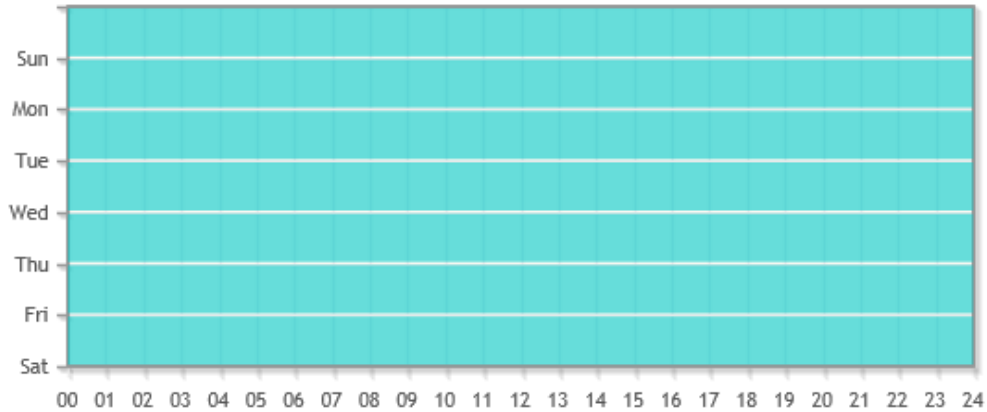

Edit

Alarm Action

Save Into Storage:	<input type="checkbox"/> File Format: Record <input type="button" value="v"/> (Please mount storage device.)
Upload Via FTP:	<input type="checkbox"/> File Format: Record <input type="button" value="v"/>
Upload Via Email:	<input type="checkbox"/> File Format: Snapshot <input type="button" value="v"/> (Please enable the Email.)
External Output:	<input type="checkbox"/> (Please configure the External Output Action Time.)
Play Audio:	<input type="checkbox"/> (Please enable the Audio Speaker.)
Alarm to SIP Phone:	<input type="checkbox"/> (Please open the SIP.)
HTTP Notification:	<input type="checkbox"/>

Alarm Setting	
Record Video Sections:	5 seconds ▼
Snapshot:	3 ▼
Snapshot Interval:	1 second ▼
Email Triggered Interval:	Auto ▼
External Output Action Time:	30 seconds ▼
Audio Action Settings:	Edit
Play Audio Interval:	Auto ▼

[Save](#)

Refer to the table in Motion Detection chapter for the meanings of the items, here will not repeat again.

External Output

External Output	
Normal Status:	<input type="radio"/> Open <input checked="" type="radio"/> Grounded
Current Status:	Grounded

[Test](#)

[Save](#)

Please set the **Normal Status** firstly, when the **Current Status** is different with **Normal Status**, it will lead to the alarm.

Exception

Alarm Type	
Enable Record Failed Alarm:	<input type="checkbox"/> Network Disconnected <input type="checkbox"/> IP Address Conflict <input checked="" type="checkbox"/> Record Failed <input type="checkbox"/> SD Card Full <input type="checkbox"/> SD Card Uninitialized <input type="checkbox"/> SD Card Error <input type="checkbox"/> No SD Card
Alarm Action	
Upload Via FTP:	<input type="checkbox"/> File Format: Record
Upload Via Email:	<input type="checkbox"/> File Format: Snapshot (Please enable the Email.)
External Output:	<input type="checkbox"/> (Please configure the External Output Action Time.)
Play Audio:	<input type="checkbox"/> (Please configure the Audio Action Settings and Audio Interval.)
Alarm to SIP Phone:	<input type="checkbox"/> (Please open the SIP.)
HTTP Notification:	<input type="checkbox"/>
Alarm Setting	
Record Video Sections:	5 seconds
Snapshot:	3
Snapshot Interval:	1 second
Email Triggered Interval:	Auto
External Output Action Time:	30 seconds
Audio Action Settings:	Edit
Play Audio Interval:	Auto
Save	

Table 43. Description of the buttons

Parameters	Function Introduction
Alarm Type	<p>Network Disconnected, IP Address Conflicted, Record Failed, SD Card Full, SD Card Uninitialized, SD Card Error and No SD Card are available</p> <p>Check the checkbox to enable the alarm type you selected</p>

Parameters	Function Introduction
<p style="text-align: center;">Alarm Action</p>	<p>Save Into Storage: Save alarm recording files into SD Card</p> <p>Upload Via Email: Upload alarm recording files via email. This option is available for Record Failed, SD Card Full, SD Card Uninitialized, SD Card Error and No SD Card</p> <p>External Output: If the camera equips with External Output, you can enable the action after configuring the trigger duration</p> <p>Play Audio: If the camera equips with Speaker, you can enable the action after configuring the audio speaker</p> <p>Alarm to SIP Phone: Support to call the SIP phone after enable the SIP function.</p> <p>HTTP Notification: Enable the HTTP Notification</p> <p>HTTP Notification URL: There are three types of HTTP Notification URL, including URL1, URL2 and URL3.</p> <ul style="list-style-type: none"> • Enable: Check the checkbox to enable a kind of HTTP Notification URL. • Trigger Interval: Trigger Interval of camera pushing information to some third-party devices. • HTTP Method: There are two HTTP push methods, including Post and Get. • URL: Camera can use the API URL to send face detection information to back-end devices when the detected face is captured. The format of the API URL depends on the back-end devices, including server, port and other required formats. For example, if you want to send information to Milesight VMS Enterprise, the format of the API URL is as follows: http://VMS server IP: VMS Port/api/httpEvent <p> Note: It supports HTTPS for HTTP Post.</p> <ul style="list-style-type: none"> • User Name: Receiver name. • Password: Receiver Password. <p>Play Buzzer: If the camera equips with Buzzer, you can check the checkbox to enable the function</p> <p>White LED: The White LED could flash as a warning signal when the alarm triggered if the camera equipped with it(only for Mini PTZ Bullet)</p>

Parameters	Function Introduction
Alarm Setting	<p>Record Video Sections: Six different periods are available(5, 10, 15, 20, 25, 30 sec)</p> <p>Snapshot: The number of snapshot, 1~5</p> <p>Snapshot Interval: This cannot be edited unless you choose more than 1 to Snapshot</p> <p>Email Triggered Interval: Auto / 10 seconds / 20 seconds / 40 seconds / 60 seconds / 100 seconds / 5 minutes / 15 minutes / 30 minutes / 1 hour / 8 hours / 12 hours / 24 hours are available. This cannot be set unless when you choose Record Failed, SD Card Full, SD Card Uninitialized, SD Card Error or No SD Card and check the Upload via Email checkbox of related Alarm type</p> <p>External Output Action Time: Length of time an alarm lasts, this cannot be edited unless when you enable the External Output on the Alarm Action firstly</p> <p>Audio Action Settings: Set the audio schedule to trigger different audio files and action times in different time, which is corresponded to alarm action</p> <p>Play Audio Interval: Auto/ 10 seconds/ 30 seconds/ 1 minute/ 5 minutes/ 10 minutes are available, this cannot be edited unless when you check the Play Audio checkbox firstly</p> <p>White LED Flash Mode: Twinkle and Always are available.</p> <p>White LED Flash Time: The duration of flash. Twinkle from 1 second to 10 seconds; Always from 1 second to 60 seconds</p> <p>White LED Effective Mode: Always, Light Environment and Customize are available. Always Mode allows to keep White LED always on. Light Environment Mode allows to set the Effective Light Intensity to turn on White LED basing on Current Light Intensity. Customize Mode allows to set the start time and the end time to control White LED</p>

5.6.2 VCA Event

Smart Event uses Milesight VCA(Video Content Analysis) technology, which provides advanced, accurate smart video analysis for Milesight network cameras. Powered by AI chip,the new generation video analytics is capable of recognizing vast attributes of human, vehicle, and object pattern recognition models. As vehicle and human related events are very important in security monitoring, the filtering is supported to better optimize the efficiency.

Note:

- There are AI and non-AI cameras in Milesight network cameras.

Region Entrance

Region entrance helps to protect a special area from potential threat of suspicious person's or object's entrance. An alarm will be triggered when objects enter the selected regions by enabling region entrance.

Region Entrance Interface (for non-AI cameras)

Event >> VCA Event

Region Entrance Region Exiting Advanced Motion Detection Tamper Detection Line Crossing Loitering Human Detection Object Left/Removed

Enable Region Entrance Detection:

Sensitivity:

Effective Region Settings: Normal

Set Entrance Detection Region

Detection Region: Edit

Object Size Limits: Edit

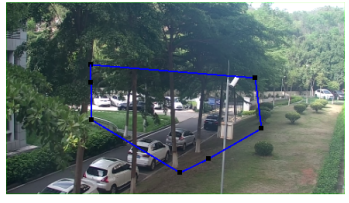

Clear All

● Min. Size: * pixel(1*1-320*240)
 ○ Max. Size: * pixel(1*1-320*240)

Region Entrance Interface (for AI cameras)

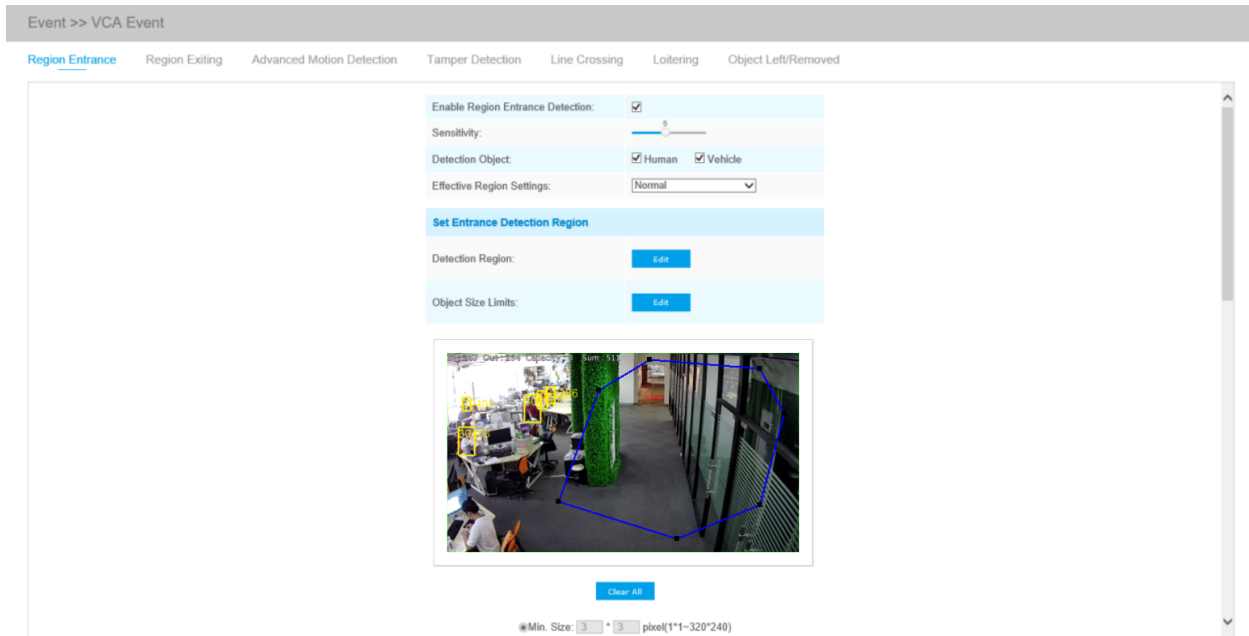

Step1: Enable region entrance detection and set detecting sensitivity;

Choose detection object. Check Human or Vehicle attribute, and the camera will alarm once detecting people or vehicle and triggering related events;

 **Note:** All AI Cameras support this function.

Step2: Set entrance detection region. If you choose **NormalMode**, it supports configuring the detection region for the current area. If you choose **AdvancedMode**(Only for PTZ series), it supports configuring the detection region for different PTZ presets (Only support Preset 1~4 so far). And set object size limits.

Table 44. Description of the buttons

Parameters	Function Introduction
Minimum Size	Draw the screen or input pixel number to set the minimum size of the detected object. When the object is smaller than this size, it will not be detected. The default minimum size is 3*3.
Maximum Size	Draw the screen or input pixel number to set the maximum size of the detected object. When the object is larger than this size, it will not be detected. The default maximum size is 320*240.

Step3: Set detection schedule;

Step4: Set alarm action. When enabling PTZ Auto Tracking and Region Entrance Detection, camera will automatically track objects and trigger an alarm if objects enter the selected regions;

Alarm Action	
Save Into Storage:	<input type="checkbox"/> File Format: Record (Please mount storage device.)
Upload Via FTP:	<input type="checkbox"/> File Format: Record
Upload Via Email:	<input type="checkbox"/> File Format: Snapshot
External Output:	<input type="checkbox"/> (Please configure the External Output Action Time.)
Play Audio:	<input type="checkbox"/> (Please enable the Audio Speaker.)
Alarm to SIP Phone:	<input type="checkbox"/> (Please open the SIP.)
HTTP Notification:	<input checked="" type="checkbox"/>
HTTP Notification URL:	URL 1
Enable:	<input checked="" type="checkbox"/>
Trigger Interval:	0 (0-900) s
HTTP Method:	Post
Snapshot:	<input type="checkbox"/>
URL:	
User Name:	
Password:	
PTZ Auto Tracking:	<input checked="" type="checkbox"/> (Please enable the Auto Tracking.)

Step5: Set alarm settings. If you enable External Output and choose Constant External Output Action Time, when objects enter the selected regions, External Output Action alarm time will be always constant till the alarm is released.

Alarm Setting	
Record Video Sections:	5 seconds
Snapshot:	3
Snapshot Interval:	1 second
Email Triggered Interval:	Auto
External Output Action Time:	Customize 10 seconds 30 seconds 1 minute 5 minutes 10 minutes Constant
Audio Action Settings:	
Play Audio Interval:	Auto

Note:

- Please enable Auto Tracking on the PTZ interface first.
- PTZ Auto Tracking is checked by default.

Region Exiting

Region exiting is to make sure that any person or object won't exit the area that is being monitored. Any exit of people or objects will trigger an alarm.

Region Exiting Interface (for non-AI cameras)

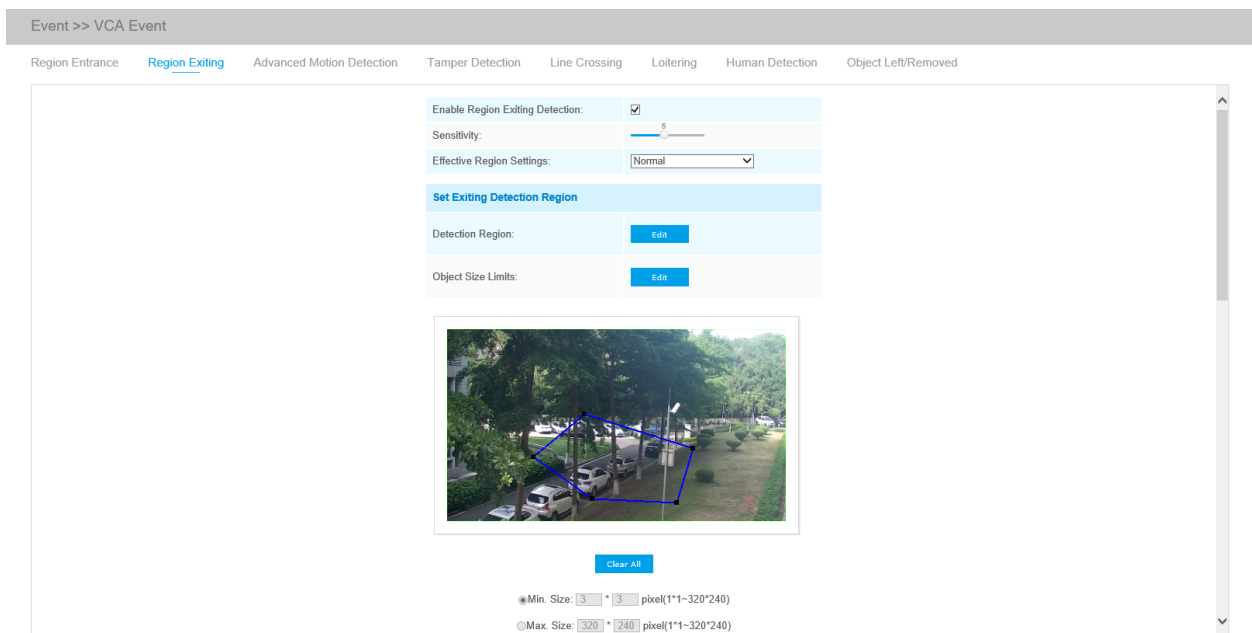

Region Exiting Interface (for non-AI cameras)

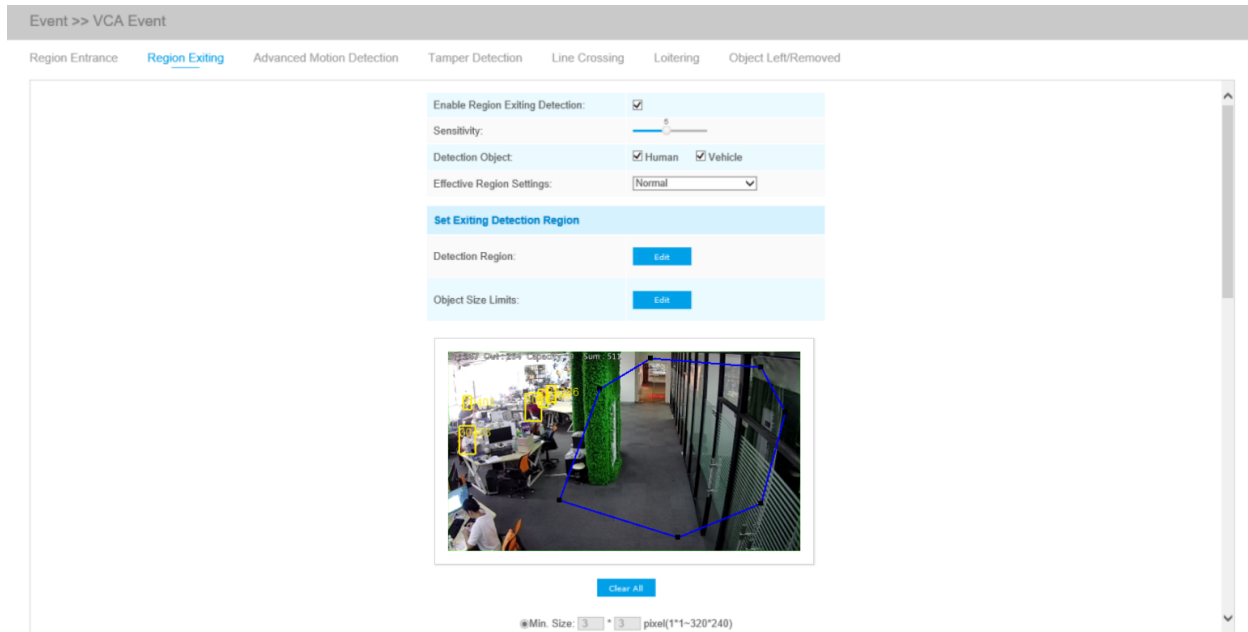

Step1: Enable region exiting detection and set detecting sensitivity;

Choose detection object. Check Human or Vehicle attribute, and the camera will alarm once detecting people or vehicle and triggering related events;

 **Note:** All AI Cameras support this function.

Step2: Set Exiting Detection Region. If you choose **NormalMode**, it supports configuring the detection region for the current area. If you choose **AdvancedMode**(Only for PTZ series), it supports configuring the detection region for different PTZ presets (Only support Preset 1~4 so far). And set object size limits;

Step3: Set detection schedule;

Step4: Set alarm action. When enabling PTZ Auto Tracking and Region Exiting Detection, camera will automatically track objects and trigger an alarm if any person or objects exit the area that is being monitored;

Alarm Action	
Save Into Storage:	<input type="checkbox"/> File Format: Record (Please mount storage device.)
Upload Via FTP:	<input type="checkbox"/> File Format: Record
Upload Via Email:	<input type="checkbox"/> File Format: Snapshot
External Output:	<input type="checkbox"/> (Please configure the External Output Action Time.)
Play Audio:	<input type="checkbox"/> (Please enable the Audio Speaker.)
Alarm to SIP Phone:	<input type="checkbox"/> (Please open the SIP.)
HTTP Notification:	<input checked="" type="checkbox"/>
HTTP Notification URL:	URL 1
Enable:	<input checked="" type="checkbox"/>
Trigger Interval:	0 (0-900) s
HTTP Method:	Post
Snapshot:	<input type="checkbox"/>
URL:	
User Name:	
Password:	
PTZ Auto Tracking:	<input checked="" type="checkbox"/> (Please enable the Auto Tracking.)

Step5: Set alarm settings. If you enable External Output and choose Constant External Output Action Time, when objects exit the selected regions, External Output Action alarm time will be always constant till the alarm is released.

Alarm Setting	
Record Video Sections:	5 seconds
Snapshot:	3
Snapshot Interval:	1 second
Email Triggered Interval:	Auto
External Output Action Time:	Customize 10 seconds 30 seconds 1 minute 5 minutes 10 minutes Constant
Audio Action Settings:	
Play Audio Interval:	Auto

Advanced Motion Detection

Different from traditional motion detection, Milesight advanced motion detection can filter out “noise” such as lighting changes, natural tree movements, etc. When an object moves in the selected area, it will trigger alarm.

Advanced Motion Detection Interface (for AI cameras)

The screenshot displays the 'Advanced Motion Detection' configuration page within a web interface. At the top, a navigation bar shows 'Event >> VCA Event' and several menu items: 'Region Entrance', 'Region Exiting', 'Advanced Motion Detection' (highlighted), 'Tamper Detection', 'Line Crossing', 'Loitering', 'Human Detection', and 'Object Left/Removed'. The main configuration area includes the following settings:

- Enable Advanced Motion Detection:**
- Sensitivity:** A slider control set to 8.
- Ignore Short-Lived Motion:** A dropdown menu set to 'Off'.
- Effective Region Settings:** A dropdown menu set to 'Normal'.

Below these settings is a section titled 'Set Advanced Motion Detection Region' with two options:

- Detection Region:** An 'edit' button.
- Object Size Limits:** An 'edit' button.

A central video preview window shows a street scene with a blue polygonal detection region overlaid on the road. Below the video is a 'Clear All' button. At the bottom of the interface, a status bar indicates: 'Min. Size: 3 * 3 pixel(1*1~320*240)'.

Advanced Motion Detection Interface (for AI cameras)

Event >> VCA Event

Region Entrance Region Exiting **Advanced Motion Detection** Tamper Detection Line Crossing Loitering Object Left/Removed

Enable Advanced Motion Detection:

Sensitivity:

Ignore Short-Lived Motion:

Detection Object: Human Vehicle

Effective Region Settings:

Set Advanced Motion Detection Region

Detection Region:

Object Size Limits:



Step1: Enable region detection and set detecting sensitivity;

Step2: Set Ignore Short-Lived Motion time. If you set the time, when the moving duration of an object is within the setting time, the alarm will not be triggered;

Choose detection object. Check Human or Vehicle attribute, and the camera will alarm once detecting people or vehicle and triggering related events;

 **Note:** All AI Cameras support this function.

Step3: Set advanced motion detection region. If you choose **NormalMode**, it supports configuring the detection region for the current area. If you choose **AdvancedMode**(Only for PTZ series), it supports configuring the detection region for different PTZ presets (Only support Preset 1~4 so far). And set object size limits.

Step4: Set detection schedule;

Step5: Set alarm action;

Alarm Action	
Save Into Storage:	<input type="checkbox"/> File Format: Record (Please mount storage device.)
Upload Via FTP:	<input type="checkbox"/> File Format: Record
Upload Via Email:	<input type="checkbox"/> File Format: Snapshot
External Output:	<input type="checkbox"/> (Please configure the External Output Action Time.)
Play Audio:	<input type="checkbox"/> (Please enable the Audio Speaker.)
Alarm to SIP Phone:	<input type="checkbox"/> (Please open the SIP.)
HTTP Notification:	<input checked="" type="checkbox"/>
HTTP Notification URL:	URL 1
Enable:	<input checked="" type="checkbox"/>
Trigger Interval:	0 (0-900) s
HTTP Method:	Post
Snapshot:	<input type="checkbox"/>
URL:	
User Name:	
Password:	
PTZ Motion:	<input type="checkbox"/>

Step6: Set alarm settings. If you enable External Output and choose Constant External Output Action Time, when object motion time is longer than the Ignore Short-Lived Motion time which you set in the selected regions, External Output Action alarm time will be always constant till the alarm is released.

Alarm Setting	
Record Video Sections:	5 seconds
Snapshot:	3
Snapshot Interval:	1 second
Email Triggered Interval:	Auto
External Output Action Time:	Customize 10 seconds 30 seconds 1 minute 5 minutes 10 minutes Constant
Audio Action Settings:	
Play Audio Interval:	Auto

Note:

- The sensitivity can be configured to detect various movement according to different requirements. When the level of sensitivity is low, slight movement won't trigger the alarm.

- Ignore Short-Lived Motion time is to avoid false alarm caused by instant object movement within time setting.

Tamper Detection

Tamper Detection is used to detect possible tampering like the camera being unfocused, obstructed or moved. This functionality alerts security staff immediately when any above-mentioned actions occur.

Event >> VCA Event

Region Entrance Region Exiting Advanced Motion Detection **Tamper Detection** Line Crossing Loitering Human Detection Object Left/Removed

Enable Tamper Detection:

Sensitivity:

Schedule Settings

Sun	00	01	02	03	04	05	06	07	08	09	10	11	12	13	14	15	16	17	18	19	20	21	22	23	24
Mon	[Active]																								
Tue	[Active]																								
Wed	[Active]																								
Thu	[Active]																								
Fri	[Active]																								
Sat	[Active]																								

[Edit](#)

Alarm Action

Save Into Storage: File Format: Record
(Please mount storage device.)

Upload Via FTP: File Format: Record

Upload Via Email: File Format: Snapshot
(Please enable the Email.)

Step1: Enable Tamper Detection and set detecting sensitivity;

Step2: Set detection schedule;

Step3: Set alarm action;

Alarm Action	
Save Into Storage:	<input type="checkbox"/> File Format: Record (Please mount storage device.)
Upload Via FTP:	<input type="checkbox"/> File Format: Record
Upload Via Email:	<input type="checkbox"/> File Format: Snapshot
External Output:	<input type="checkbox"/> (Please configure the External Output Action Time.)
Play Audio:	<input type="checkbox"/> (Please enable the Audio Speaker.)
Alarm to SIP Phone:	<input type="checkbox"/> (Please open the SIP.)
HTTP Notification:	<input checked="" type="checkbox"/>
HTTP Notification URL:	URL 1
Enable:	<input checked="" type="checkbox"/>
Trigger Interval:	0 (0-900) s
HTTP Method:	Post
Snapshot:	<input type="checkbox"/>
URL:	<input type="text"/>
User Name:	<input type="text"/>
Password:	<input type="text"/>

Step4: Set alarm settings. If you enable External Output and choose Constant External Output Action Time, when possible tampering is detected, External Output Action alarm time will be always constant till the alarm is released.

Alarm Setting	
Record Video Sections:	5 seconds
Snapshot:	3
Snapshot Interval:	1 second
Email Triggered Interval:	Auto
External Output Action Time:	<div style="border: 1px solid black; padding: 5px;"> Customize 10 seconds 30 seconds 1 minute 5 minutes 10 minutes Constant </div> s(1~999)
Audio Action Settings:	
Play Audio Interval:	Auto

 **Note:** The algorithm supports defocus detection in Tamper Detection function.

Line Crossing

Line Crossing detection is designed to work in most indoor and outdoor environment. An event will be triggered every time when the camera detects objects crossing a defined virtual line.

Line Crossing Interface(for non-AI cameras)

Event >> VCA Event

Region Entrance Region Exiting Advanced Motion Detection Tamper Detection **Line Crossing** Loitering Human Detection Object Left/Removed

Line Crossing:	1
Enable Line Crossing Detection:	<input checked="" type="checkbox"/>
Direction:	A->B
Sensitivity:	<input type="range" value="5"/>
Effective Region Settings:	Normal

Set Detection Lines

Detection Line:	Edit
Object Size Limits:	Edit



[Clear Line](#)

Line Crossing Interface(for AI cameras)

Event >> VCA Event

Region Entrance Region Exiting Advanced Motion Detection Tamper Detection **Line Crossing** Loitering Object Left/Removed

Line Crossing:	1
Enable Line Crossing Detection:	<input checked="" type="checkbox"/>
Direction:	A->B
Detection Object:	<input checked="" type="checkbox"/> Human <input checked="" type="checkbox"/> Vehicle
Sensitivity:	<input type="range" value="5"/>
Effective Region Settings:	Normal

Set Detection Lines

Detection Line:	Edit
Object Size Limits:	Edit

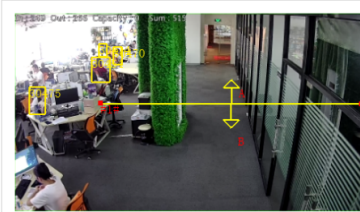

Settings steps are shown as follows:

Step1: Choose a line number;

Line Crossing:	1 2 3 4
Enable Line Crossing Detection:	<input type="checkbox"/>
Direction:	A->B
Sensitivity:	5

Step2: Enable Line Crossing Detection and define its direction;

Line Crossing:	1
Enable Line Crossing Detection:	<input type="checkbox"/>
Direction:	A->B B->A A<->B
Sensitivity:	

Choose detection object. Check Human or Vehicle attribute, and the camera will alarm once detecting people or vehicle and triggering related events;

 **Note:** All AI Cameras support this function.

Step3: Set detecting sensitivity;

Step4: Draw detection lines. If you choose **NormalMode**, it supports configuring the detection lines for the current area. If you choose **AdvancedMode**(Only for PTZ series), it supports configuring different detection lines for different PTZ presets (Only support Preset 1~4 so far). And set object size limits.

Step5: Set detection schedule;

Step6: Set alarm action. When enabling PTZ Auto Tracking, camera will automatically track objects and trigger an alarm if detecting objects crossing a defined virtual line;

Alarm Action	
Save Into Storage:	<input type="checkbox"/> File Format: Record (Please mount storage device.)
Upload Via FTP:	<input type="checkbox"/> File Format: Record
Upload Via Email:	<input type="checkbox"/> File Format: Snapshot
External Output:	<input type="checkbox"/> (Please configure the External Output Action Time.)
Play Audio:	<input type="checkbox"/> (Please enable the Audio Speaker.)
Alarm to SIP Phone:	<input type="checkbox"/> (Please open the SIP.)
HTTP Notification:	<input checked="" type="checkbox"/>
HTTP Notification URL:	URL 1
Enable:	<input checked="" type="checkbox"/>
Trigger Interval:	0 (0-900) s
HTTP Method:	Post
Snapshot:	<input type="checkbox"/>
URL:	
User Name:	
Password:	
PTZ Auto Tracking:	<input checked="" type="checkbox"/> (Please enable the Auto Tracking.)

Step7: Set alarm settings. If you enable External Output and choose Constant External Output Action Time, when objects cross a defined virtual line, External Output Action alarm time will be always constant till the alarm is released.

Alarm Setting	
Record Video Sections:	5 seconds
Snapshot:	3
Snapshot Interval:	1 second
Email Triggered Interval:	Auto
External Output Action Time:	Customize 10 seconds 30 seconds 1 minute 5 minutes 10 minutes Constant
Audio Action Settings:	
Play Audio Interval:	Auto

Note: Milesight network cameras allows to set up to four lines at a time. There are three direction modes to choose for triggering alarm. “A→B” means when there is any object crossing the line from the “A” side to the “B” side, the alarm will be triggered. “B→A” vice versa. “A ↔ B” means that the alarm will be triggered when objects cross line from either side.

Loitering

When objects are loitering in a defined area for a specific period of time, it would trigger an alarm.

Loitering Interface(for non-AI cameras)

Event >> VCA Event

Region Entrance
Region Exiting
Advanced Motion Detection
Tamper Detection
Line Crossing
Loitering
Human Detection
Object Left/Removed

Enable Loitering Detection:	<input checked="" type="checkbox"/>
Min. Loitering Time:	<input type="text" value="7"/> (3~1800) s
Effective Region Settings:	<input type="text" value="Normal"/>

Set Loitering Detection Region

Detection Region:	Edit
Object Size Limits:	Edit

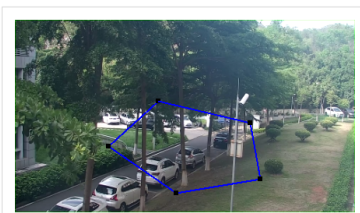

[Clear All](#)

● Min. Size: * pixel(1*1~320*240)

○ Max. Size: * pixel(1*1~320*240)

Loitering Interface(for AI cameras)

Event >> VCA Event

Region Entrance Region Exiting Advanced Motion Detection Tamper Detection Line Crossing **Loitering** Object Left/Removed

Enable Loitering Detection:	<input checked="" type="checkbox"/>
Min. Loitering Time:	<input type="text" value="7"/> (3-1800) s
Detection Object:	<input checked="" type="checkbox"/> Human <input checked="" type="checkbox"/> Vehicle
Effective Region Settings:	<input type="text" value="Normal"/>

Set Loitering Detection Region

Detection Region:	<input type="button" value="Edit"/>
Object Size Limits:	<input type="button" value="Edit"/>



#Min. Size: * pixel(1*1-320*240)

Step1: Enable loitering detection and set minimum loitering time;

Choose detection object. Check Human or Vehicle attribute, and the camera will alarm once detecting people or vehicle and triggering related events;

 **Note:** This function is supported for all AI cameras.

Step2: Set loitering detection region. If you choose **NormalMode**, it supports configuring the detection region for the current area. If you choose **AdvancedMode**(Only for PTZ series), it supports configuring the detection region for different PTZ presets (Only support Preset 1~4 so far). And set object size limits.

Step3: Set detection schedule;

Step4: Set alarm action. When enabling PTZ Auto Tracking and Loitering Detection, camera will automatically track objects and trigger an alarm if objects have been loitering in a defined area for more than the Min. Loitering Time;

Alarm Action	
Save Into Storage:	<input type="checkbox"/> File Format: Record (Please mount storage device.)
Upload Via FTP:	<input type="checkbox"/> File Format: Record
Upload Via Email:	<input type="checkbox"/> File Format: Snapshot
External Output:	<input type="checkbox"/> (Please configure the External Output Action Time.)
Play Audio:	<input type="checkbox"/> (Please enable the Audio Speaker.)
Alarm to SIP Phone:	<input type="checkbox"/> (Please open the SIP.)
HTTP Notification:	<input checked="" type="checkbox"/>
HTTP Notification URL:	URL 1
Enable:	<input checked="" type="checkbox"/>
Trigger Interval:	0 (0-900) s
HTTP Method:	Post
Snapshot:	<input type="checkbox"/>
URL:	
User Name:	
Password:	
PTZ Auto Tracking:	<input checked="" type="checkbox"/> (Please enable the Auto Tracking.)

Step5: Set alarm settings. If you enable External Output and choose Constant External Output Action Time, when objects loiter in the selected regions, External Output Action alarm time will be always constant till the alarm is released.

Alarm Setting	
Record Video Sections:	5 seconds
Snapshot:	3
Snapshot Interval:	1 second
Email Triggered Interval:	Auto
External Output Action Time:	<div style="border: 1px solid black; padding: 2px;"> Customize 10 seconds 30 seconds 1 minute 5 minutes 10 minutes Constant </div>
Audio Action Settings:	
Play Audio Interval:	Auto

Note: After setting minimum loitering time from 3s to 1800s, any objects loitering in the selected area over the minimum loitering time will trigger the alarm.

Human Detection

Human detection is used for figuring out whether an object is a human or not. Once human detection is enabled, when there is an object appearing in the detecting area, an ID will show on the frame. If the object is a person, it will mark as “person”. When the Show Tracks is enabled, the tracks of the moving object will show on the screen.

Note: Human Detection tab is no longer displayed separately for all AI cameras.

Step1: Enable Human Detection;

Step2: Check Show Tracks;

Step3: Set object size limits;

Step4: Set schedule settings;

Step5: Set alarm action. When enabling PTZ Auto Tracking, camera will mark as “person” and automatically track the person if the detected object is a person;

Alarm Action	
Save Into Storage:	<input type="checkbox"/> File Format: Record ▼ (Please mount storage device.)
Upload Via FTP:	<input type="checkbox"/> File Format: Record ▼
Upload Via Email:	<input type="checkbox"/> File Format: Snapshot ▼
External Output:	<input type="checkbox"/> (Please configure the External Output Action Time.)
Play Audio:	<input type="checkbox"/> (Please enable the Audio Speaker.)
Alarm to SIP Phone:	<input type="checkbox"/> (Please open the SIP.)
HTTP Notification:	<input type="checkbox"/>
White LED:	<input type="checkbox"/>
PTZ Auto Tracking:	<input checked="" type="checkbox"/>

Step6: Set alarm settings. If you enable External Output and choose Constant External Output Action Time, when detected object is marked as “person”, External Output Action alarm time will be always constant till the alarm is released.

Alarm Setting	
Record Video Sections:	5 seconds ▼
Snapshot:	3 ▼
Snapshot Interval:	1 second ▼
Email Triggered Interval:	Auto ▼
External Output Action Time:	<div style="border: 1px solid black; padding: 2px;"> Customize 10 seconds 30 seconds 1 minute 5 minutes 10 minutes Constant </div> s(1~999)
Audio Action Settings:	
Play Audio Interval:	Auto ▼

Object Left/Removed

Object Left can detect and prompt an alarm if an object is left in a pre-defined region. Object Removed can detect and prompt an alarm if an object is removed from a pre-defined region.

Object Left/Removed Interface(for non-AI cameras)

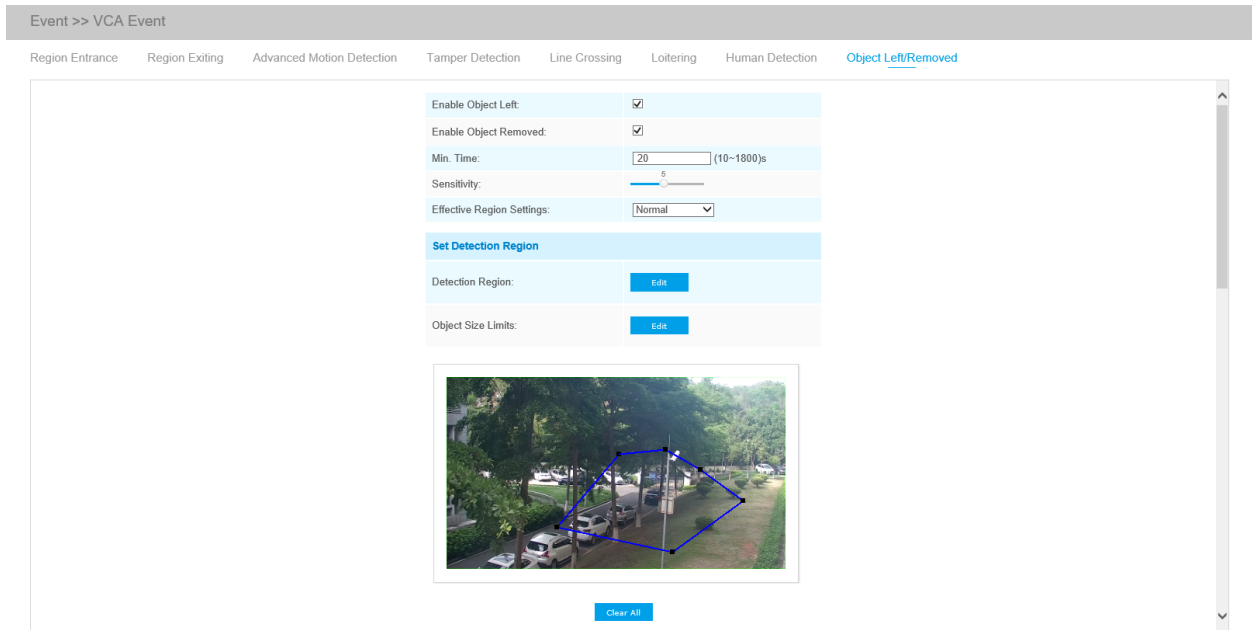

Object Left/Removed Interface(for AI cameras)

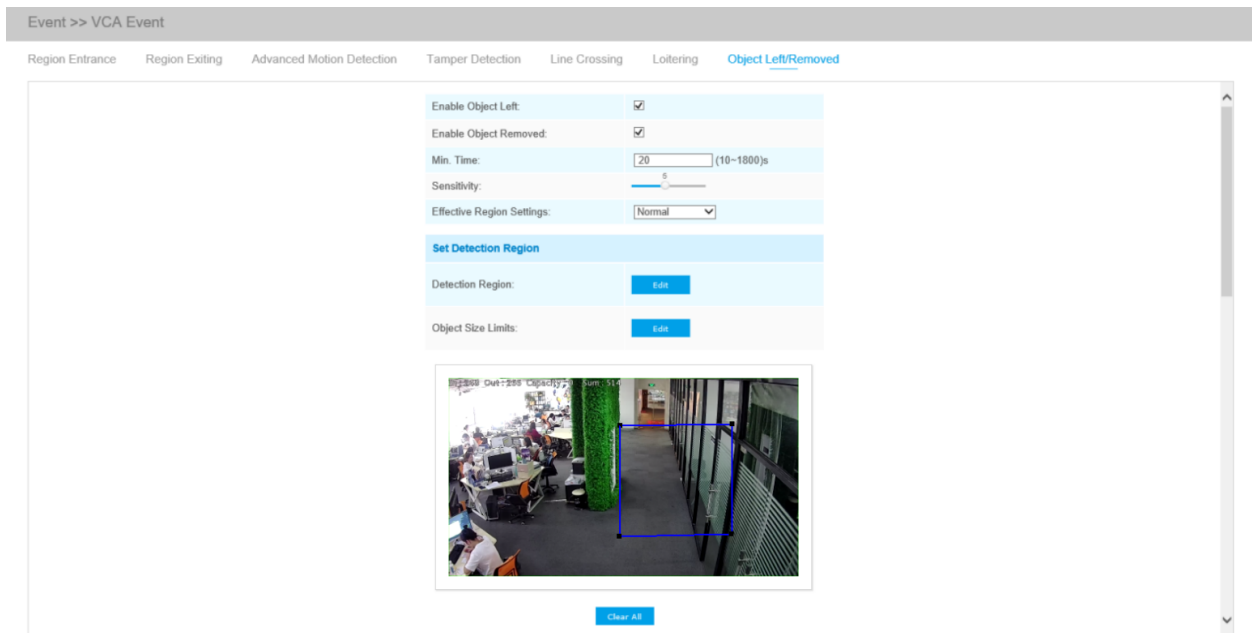

Step1: Enable Object Left or Object Removed(Or you can enable both features at the same time);

Step2: Set minimum time;

Step3: Set detecting sensitivity;

Step4: Set detection region. If you choose **NormalMode**, it supports configuring the detection region for the current area. If you choose **AdvancedMode**(Only for PTZ series), it supports configuring the detection region for different PTZ presets (Only support Preset 1~4 so far). And set object size limits.

Step5: Set detection schedule;

Step6: Set alarm action. When enabling PTZ Auto Tracking, camera will automatically track objects and trigger an alarm if an object is left or removed in a defined area;

Alarm Action	
Save Into Storage:	<input type="checkbox"/> File Format: Snapshot ▼ (Please mount storage device.)
Upload Via FTP:	<input type="checkbox"/> File Format: Record ▼
Upload Via Email:	<input type="checkbox"/> File Format: Snapshot ▼
External Output:	<input type="checkbox"/> (Please configure the External Output Action Time.)
Play Audio:	<input type="checkbox"/> (Please enable the Audio Speaker.)
Alarm to SIP Phone:	<input type="checkbox"/> (Please open the SIP.)
HTTP Notification:	<input checked="" type="checkbox"/>
HTTP Notification URL:	URL 1 ▼
Enable:	<input checked="" type="checkbox"/>
Trigger Interval:	<input type="text" value="0"/> (0-900) s
HTTP Method:	Post ▼
Snapshot:	<input type="checkbox"/>
URL:	<input type="text"/>
User Name:	<input type="text"/>
Password:	<input type="text"/>
PTZ Auto Tracking:	<input checked="" type="checkbox"/> (Please enable the Auto Tracking.)

Step7: Set alarm settings. If you enable External Output and choose Constant External Output Action Time, when an object is left/removed from the selected regions, External Output Action alarm time will be always constant till the alarm is released.

Alarm Setting	
Record Video Sections:	5 seconds
Snapshot:	3
Snapshot Interval:	1 second
Email Triggered Interval:	Auto
External Output Action Time:	<div style="border: 1px solid black; padding: 2px;"> Customize 10 seconds 30 seconds 1 minute 5 minutes 10 minutes Constant </div>
Audio Action Settings:	(1~999)
Play Audio Interval:	Auto

Note:

- After setting minimum time from 3s to 1800s, any objects are left in the selected area or removed from the selected area over the minimum time will trigger the alarm.

5.6.3 People Counting

People Counting

People Counting is able to count how many people enter or exit during the setting period.

Event >> People Counting

[People Counting](#)
[Statistics Report](#)

Enable People Counting:	<input checked="" type="checkbox"/>
Effective Region Settings:	Normal
Set Detection Lines	
Detection Line:	Edit
Object Size Limits:	Edit



[Clear Lines](#)

● Min. Size: * pixel(1*1~320*240)

○ Max. Size: * pixel(1*1~320*240)

Note: Please draw the screen for setting!

Settings steps are as shown below:

Step1: Enable People Counting;

Step2: Set detection line and object size limits. If you choose **NormalMode**, it supports configuring the detection line for the current area. If you choose **AdvancedMode**(Only for PTZ series), it supports configuring the detection line for different PTZ presets(Only support Preset 1~4 so far).

Step3: Set detection schedule;

Step4: Set counting OSD;

Counting OSD	
Show Video Title:	<input checked="" type="checkbox"/>
Font Size:	Small ▼
Font Color:	 
Text Position:	Top-Left ▼

The OSD of the people counting supports manual reset and automatic zeroing;

Counting Reset:	<div style="background-color: #00aaff; color: white; padding: 2px 5px; display: inline-block; border-radius: 3px;">Reset</div> <input type="checkbox"/> Reset the statistics report together?
Enable Auto Reset:	<input checked="" type="checkbox"/>
Day:	Everyday ▼
Time:	00:00:00 

Step5: Set alarm trigger. Alarm will be triggered when the thresholds reaches to a certain value from 1 to 9999.

Alarm Trigger	
Enable Alarm	<input checked="" type="checkbox"/>
Thresholds:	<input type="checkbox"/> In: <input type="text" value="9999"/> <input type="checkbox"/> Out: <input type="text" value="9999"/> <input type="checkbox"/> Capacity: <input type="text" value="9999"/> <input type="checkbox"/> Sum: <input type="text" value="9999"/>

Step6: Set alarm action;

Alarm Action	
Save Into Storage:	<input type="checkbox"/> File Format: Record (Please mount storage device.)
Upload Via FTP:	<input type="checkbox"/> File Format: Record
Upload Via Email:	<input type="checkbox"/> File Format: Snapshot
External Output:	<input type="checkbox"/> (Please configure the External Output Action Time.)
Play Audio:	<input type="checkbox"/> (Please enable the Audio Speaker.)
Alarm to SIP Phone:	<input type="checkbox"/> (Please open the SIP.)
HTTP Notification:	<input checked="" type="checkbox"/>
HTTP Notification URL:	URL 1
Enable:	<input checked="" type="checkbox"/>
Trigger Interval:	0 (0-900) s
HTTP Method:	Post
Snapshot:	<input type="checkbox"/>
URL:	
User Name:	
Password:	

Step7: Set alarm settings. If you enable External Output and choose Constant External Output Action Time, when the thresholds reach to a certain value you set, External Output Action alarm time will be always constant till the alarm is released.

Alarm Setting	
Record Video Sections:	5 seconds
Snapshot:	3
Snapshot Interval:	1 second
Email Triggered Interval:	Auto
External Output Action Time:	<div style="border: 1px solid black; padding: 5px;"> Customize 10 seconds 30 seconds 1 minute 5 minutes 10 minutes Constant </div>
Audio Action Settings:	
Play Audio Interval:	Auto

Save

 **Note:** Crossing along the direction of the arrow will record as “In”, opposite is “Out”.

Regional People Counting

When enabling Regional People Counting, users can check the real-time number of people and the time of each person's stay in the detection region.

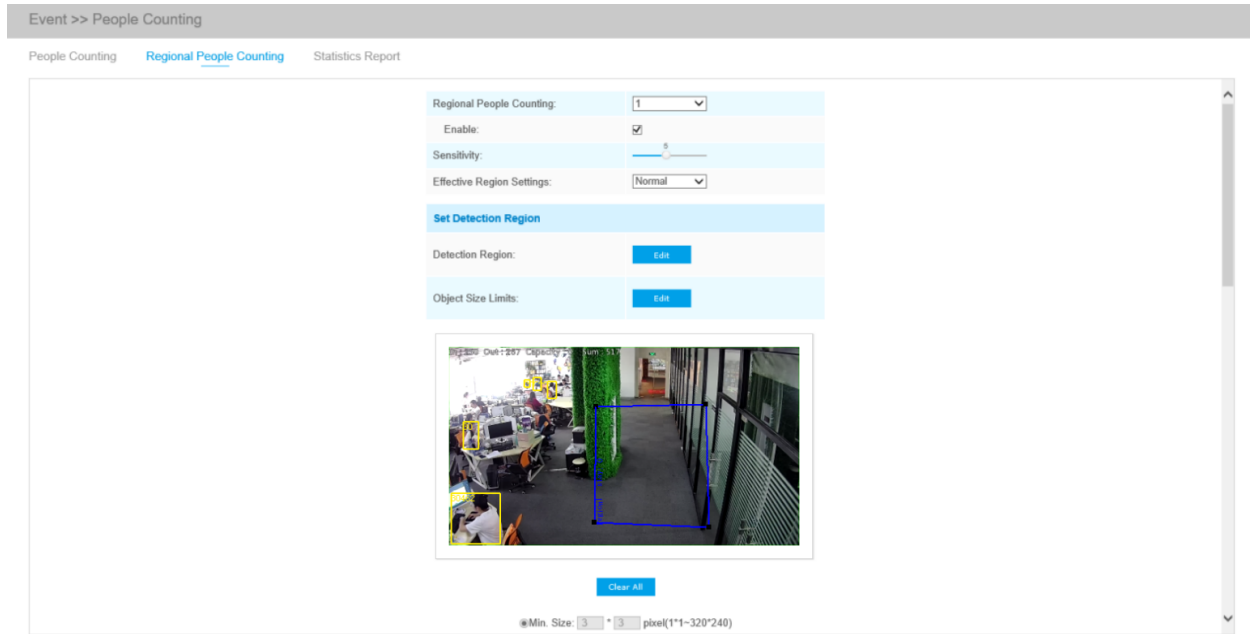

Settings steps are as shown below:

Step1: Enable Region People Counting;

Step2: Set detection region and object size limits;

Step3: Set detection schedule;

Step4: Set alarm trigger. Alarm will be triggered when the thresholds exceeds the certain value.

Alarm Trigger	
Max. Stay:	<input checked="" type="checkbox"/> 60
Min. Stay:	<input checked="" type="checkbox"/> 1
Max. Length of Stay:	<input checked="" type="checkbox"/> 30 s

Step6: Set alarm action;

Alarm Action	
Save Into Storage:	<input type="checkbox"/> File Format: Record (Please mount storage device.)
Upload Via FTP:	<input type="checkbox"/> File Format: Record
Upload Via Email:	<input type="checkbox"/> File Format: Snapshot (Please enable the Email.)
External Output:	<input type="checkbox"/> (Please configure the External Output Action Time.)
Play Audio:	<input type="checkbox"/> (Please enable the Audio Speaker.)
Alarm to SIP Phone:	<input type="checkbox"/> (Please open the SIP.)
HTTP Notification:	<input checked="" type="checkbox"/>
HTTP Notification URL:	URL 1
Enable:	<input checked="" type="checkbox"/>
Trigger Interval:	0 (0-900) s
HTTP Method:	Post
Snapshot:	<input type="checkbox"/>
URL:	undefined
User Name:	undefined
Password:	••••••••

Step7: Set alarm settings. If you enable External Output and choose Constant External Output Action Time, when the thresholds exceeds the certain value you set, External Output Action alarm time will be always constant till the alarm is released.

Alarm Setting	
Record Video Sections:	5 seconds
Snapshot:	3
Snapshot Interval:	1 second
Email Triggered Interval:	Auto
External Output Action Time:	Customize (1~999)
Audio Action Settings:	10 seconds 30 seconds 1 minute 5 minutes 10 minutes Constant
Play Audio Interval:	Auto

Save

Note:

- Users can check the real-time number of people and the time of each person's stay in the detection region on Live View interface.

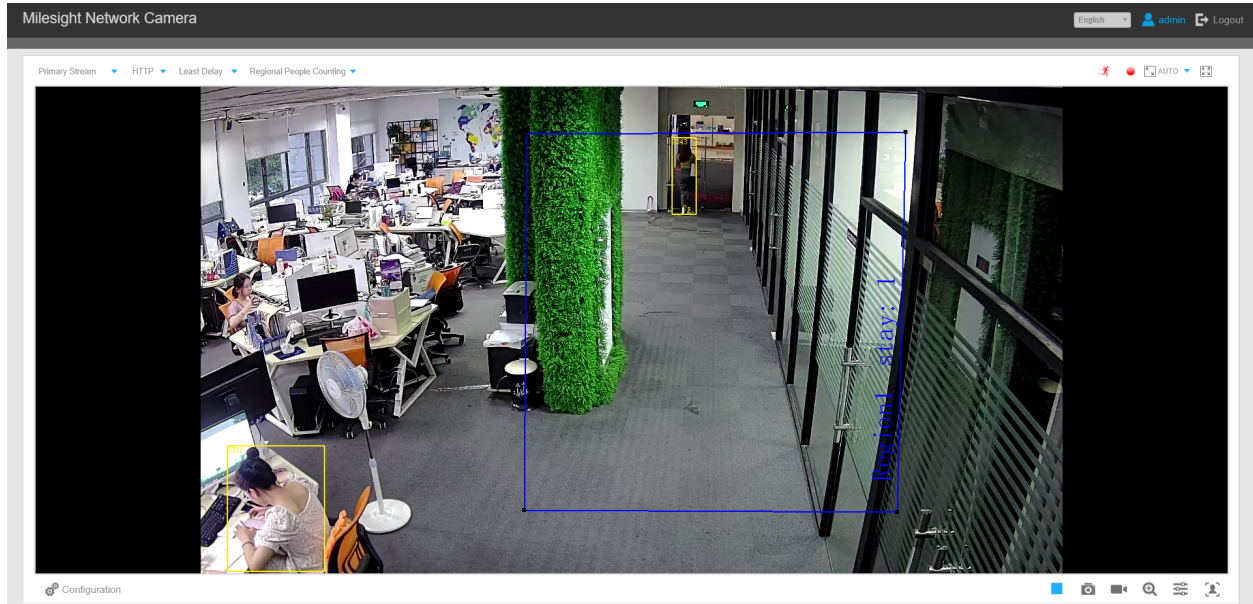

- For Regional People Counting, please make sure your camera model is MS-CXXXX-XXC.
- Support up to 4 detection regions for regional people counting.

Statistics Report

The results during the enabling period will be displayed on “**Statistics Report**” interface.

Event >> People Counting



People Counting [Statistics Report](#)

Statistics Result	Report Search
	Main Type: <input type="text" value="People Counting"/>
	Report Type: <input type="text" value="Daily Report"/>
	Statistics Type: <input type="text" value="People Entered"/>
	Start Time: <input type="text" value="2021-02-20 00:00:00"/>
	<input type="button" value="Search"/>
	<input type="button" value="Report Export"/>
	<input type="button" value="Auto Export"/>

Step 1: Select Main Type;

Step2: Select Report Type including Daily Report, Weekly Report, Monthly Report and Annual Report;

Step3: Select Statistics Type including People Entered, People Exited and Sum;

Step4: Select Start Time, then click  button, the camera will automatically count the data for the day/ week/ month/ year (based on the report type selected by the user) from the start time and generate the corresponding report. Moreover, you can also click  or  to switch display mode of Statistics Report as shown below.

People Counting-Statistics Report (Line Chart)

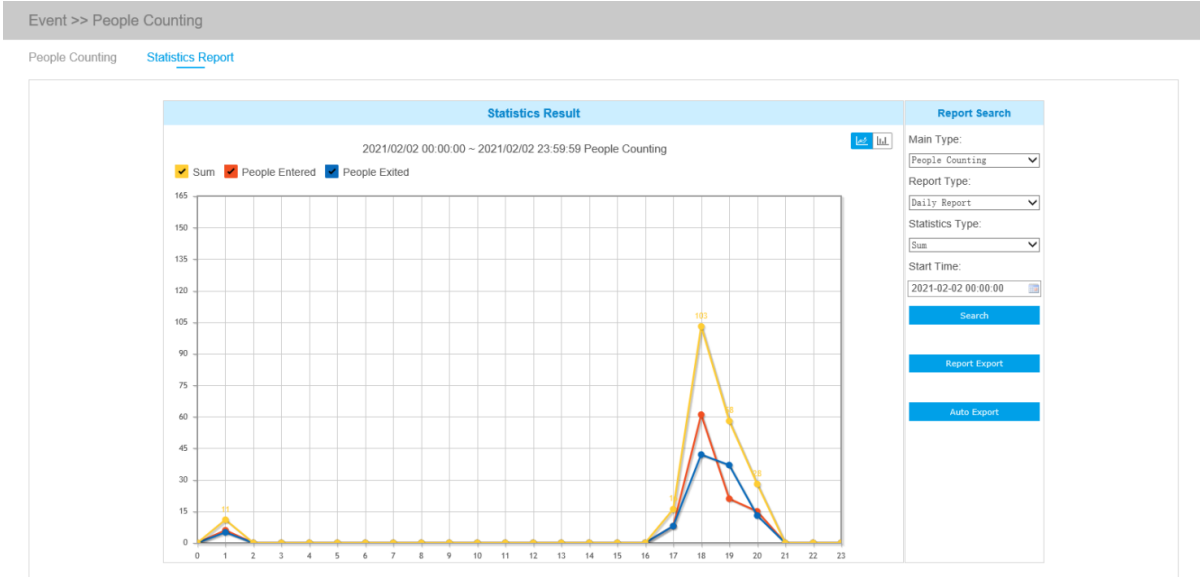

People Counting-Statistics Report (Bar Chart)

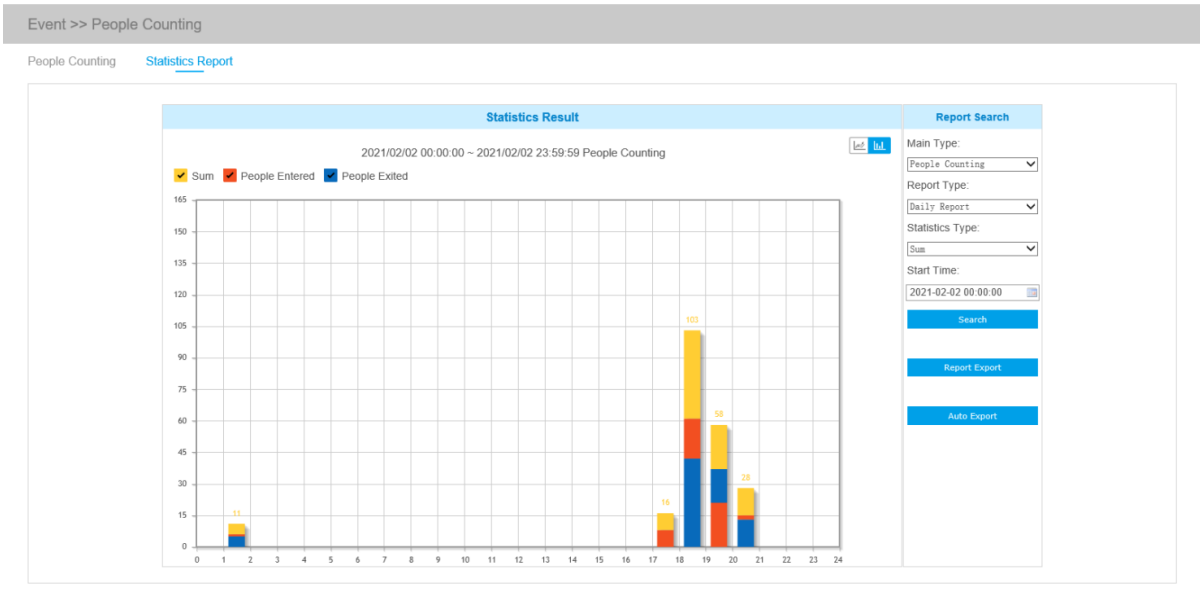

Regional People Counting-Statistics Report (Line Chart)

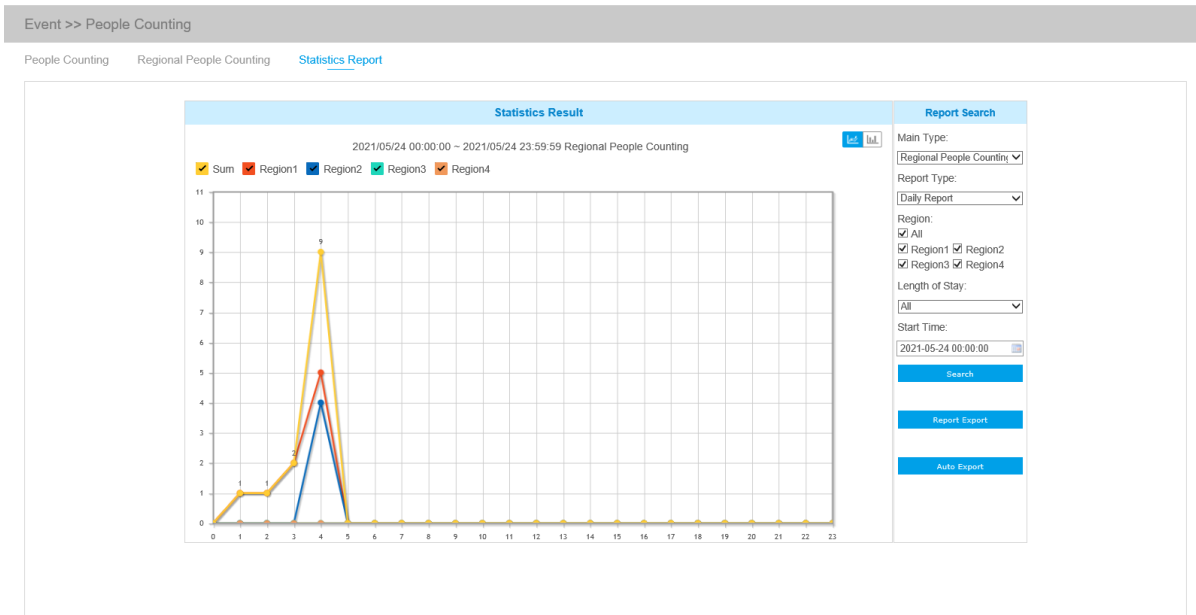

Regional People Counting-Statistics Report (Bar Chart)

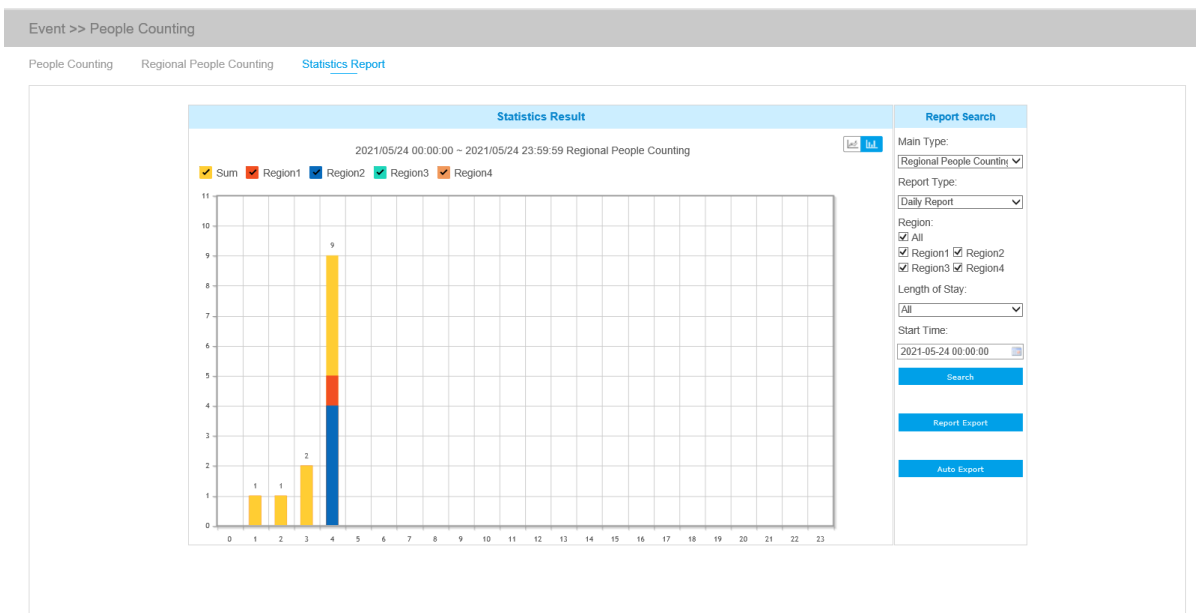

Step5: Click **Report Export** button to pop up the Export window as shown below, and you can choose File Format to export the report to local.

Export

File Format: PNG CSV

Save

Step6: Click  button to pop up the Statistics Report Settings as shown below.

Statistics Report Settings

Export Type: People Counting

Enable:

Day: Everyday

Time: 00:00:00

Export Time Range: Last 1 day

Export to: FTP Email Storage

Save

- Set Export Type. User can check People Counting. When People Counting is checked, the gray item becomes editable as shown below;
- Set Day. User can choose Everyday to export daily reports, while choosing others to export reports on a specific day of the week;

Statistics Report Settings

Export Type: Regional People Counting ▾

Enable:

Length of Stay: All More Than Less Than 60 ▾ s

Day: Everyday ▾

Time: 00:00:00

Export Time Range: Last 1 day ▾

Export to: FTP Email Storage

Save

- Set Time. User can choose the time of day to export the Statistics Report automatically, click the calendar icon to pop up the following Quick Selection;

Statistics Report Settings

Export Type: Regional People Counting ▾

Enable:

Length of Stay: All ▾

Day: Everyday Sunday Monday Tuesday Wednesday Thursday Friday Saturday

Time:

Export Time Range:

Export to: FTP Email Storage

Save

- Set Export Time Range;

Day (Choose Everyday)

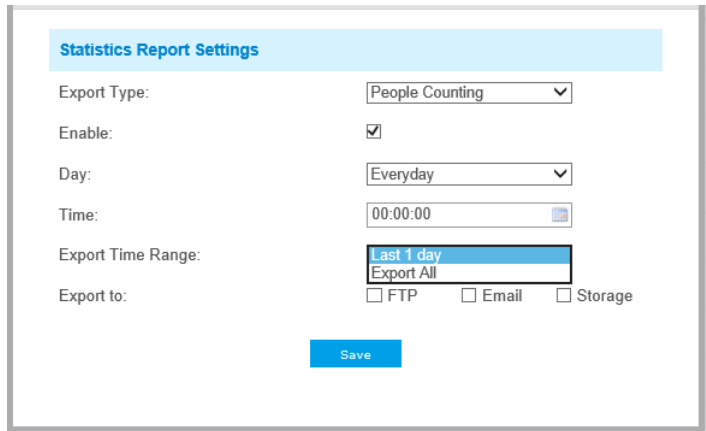

Day (Choose Week)

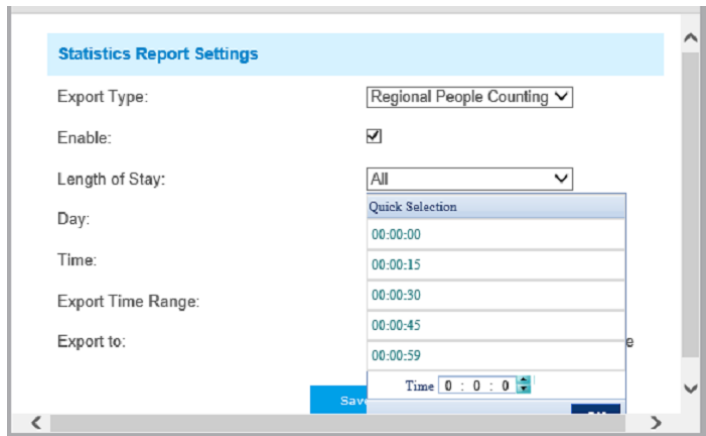

- Set the destination path of the automatically exported report. The report can be exported to FTP/Email/Storage automatically as the form of an Excel spreadsheet according to the day, time and export time range you set. Then click “Save”.

Statistics Report Settings

Export Type:

Enable:

Day:

Time:

Export Time Range:

Export to: FTP Email Storage

 **Note:** If the current Statistics Report is generated, it will be saved as a csv form.

5.6.4 Face Detection (Optional)

The Face Detection function can detect the face appearing in the drawn area and support saving face snapshots into Storage, upload via FTP or Email, display in Live View.

General

 **Note:** Currently Face Detection is only supported by AI cameras.

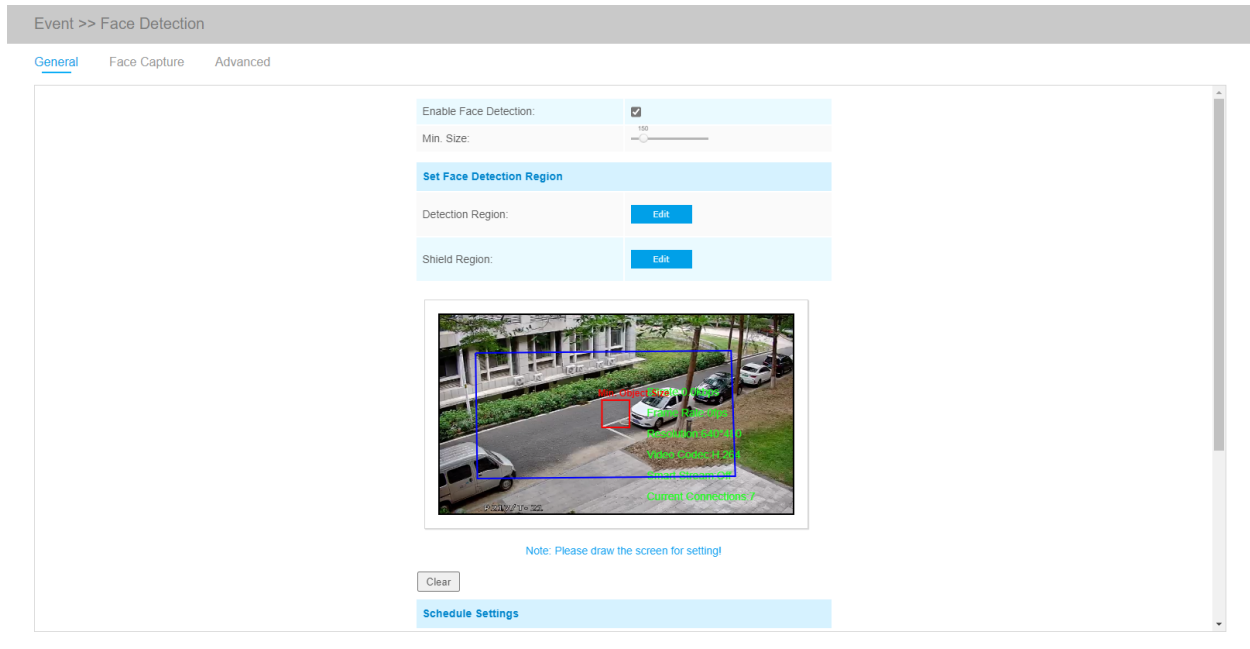

Settings steps are as shown below:

Step1: Enable Face Detection;

Step2: Set Min. Object Size;

Step3: Set detection region, you can drag the detection region to adjust the size. Only faces in this region will be detected;

Step4: Set Shield Region is to make faces in the some places of detection region be not detected. The faces can be set to be not detected in some places of detection region via setting the Shield Region. You can draw a Shield Region in the preview interface firstly, then click Add button. There are at most four Shield Region drawn are available;

Step5: Set detection schedule and click “Save”.

Face Capture





Here you can make configuration for face capture snapshot.



Face Capture Configuration	
Capture Mode:	Quality Priority ▾
Capture Quality:	1 <input type="range"/>
Snapshot Type:	Face Only ▾ <input checked="" type="checkbox"/> Background
Snapshot:	1 ▾
Record Video Sections:	30 seconds ▾
Save Into NAS:	<input type="checkbox"/> File Format: Snapshot ▾
Upload Via FTP:	<input type="checkbox"/> File Format: All ▾
Upload Via Email:	<input type="checkbox"/> File Format: Snapshot ▾

Face Detection Message Post Settings	
Enable Face Detection Message Post:	<input checked="" type="checkbox"/>
Post Type:	HTTP ▾
HTTP Notification URL:	URL 1 ▾
Enable:	<input checked="" type="checkbox"/>
Trigger Interval:	0 (0-900) s
HTTP Method:	Post ▾
Snapshot:	<input type="checkbox"/>
URL:	<input type="text"/>
User Name:	Leah
Password:	••••••••

[Save](#)

Table 45. Description of the buttons

Parameters	Function Introduction
<p>Capture Mode</p>	<p>Auto Mode, Quality Priority, Timeliness Priority, Customize are available.</p> <p>Auto Mode: In this mode, it will push a face screenshot based on screenshot quality and push speed when the face is detected.</p> <p>Quality Priority: In this mode, it will push a face screenshot of best quality when the face is detected.</p> <p>Timeliness Priority: In this mode, it will push a face screenshot in the shortest time when the face is detected.</p> <p>Customize: In this mode, you can customize some detect conditions, including Snapshot Interval, Oblique Face Angle Limit, Pitching Face Angle Limit, Side Face Angle Limit, Blur Limit.</p>
<p>Snapshot Interval</p>	<p>80 milliseconds, 200 milliseconds, 500 milliseconds, 1 second, 2 seconds and 4 seconds are available.</p> <p> Note: Optional for Customize mode.</p>
<p>Oblique Face Angle Limit</p>	<p>Set Oblique Face Angle Limit to 1~180. The larger the value, the larger angle the oblique face that can be detected.</p> <p> Note: Optional for Customize mode.</p>
<p>Pitching Face Angle Limit</p>	<p>Set Pitching Face Angle Limit to 1~180. The larger the value, the larger angle the pitching face that can be detected.</p> <p> Note: Optional for Customize mode.</p>
<p>Side Face Angle Limit</p>	<p>Set Side Face Angle Limit to 1~180. The larger the value, the larger angle the side face that can be detected.</p> <p> Note: Optional for Customize mode.</p>
<p>Blur Limit</p>	<p>Set Blur Limit to 1~10. The larger the value, the more blurred the face can be detected.</p> <p> Note: Optional for Customize mode.</p>
<p>Snapshot Type</p>	<p>Face Only, Upper Body, Whole Body are available.</p> <p>Face Only: Capture the screenshot of face only.</p> <p>Upper Body: Capture the screenshot of upper body.</p> <p>Whole Body: Capture the screenshot of whole body.</p> <p>If you check the "Background" option, it will take another screenshot of the entire image.</p>

Parameters	Function Introduction
Snapshot	Set the number of screenshot to 1~5. It will take screenshot based on the snapshot interval you set.
Record Video Sections	Six different periods are available(5, 10, 15, 20, 25, 30 sec).
Save Into NAS	Save the alarm files into NAS.
Upload Via FTP	Upload the alarm files via FTP.
Upload Via Email	Upload the alarm files via Email.
Enable Face Detection Message Post Settings	Check the checkbox to enable Face Detection Message Post. It will push information to some third-party devices or compatible software. Information can be pushed by TCP or HTTP.
Post Type	Information can be pushed by TCP or HTTP .
HTTP Notification URL	There are three types of HTTP Notification URL, including URL1,URL2 and URL3.
Enable	Check the checkbox to enable a kind of HTTP Notification URL.
Trigger Interval	Trigger Interval of camera pushing information to some third-party devices.
HTTP Method	There are two HTTP push methods, including Post and Get.
Snapshot	<p>Choose whether to push information with snapshot to some third-party devices or software.</p> <p> Note: This option is available just for URL1.</p>
URL	<p>Camera can use the API URL to send face detection information to back-end devices when the detected face is captured.</p> <p>The format of the API URL depends on the back-end devices, including server, port and other required formats.</p> <p>For example, if you want to send information to Milesight VMS Enterprise, the format of the API URL is as follows:</p> <p><u>http://VMS server IP: VMS Port/api/httpEvent</u></p> <p> Note: It supports HTTPS for HTTP Post.</p>
User Name	Receiver name.
Password	Receiver Password.

Camera will detect faces in Live View according to the region and conditions you set. If you check the "Show Tracks" option, it will display the face screenshot with the ID on the left side of Live View.

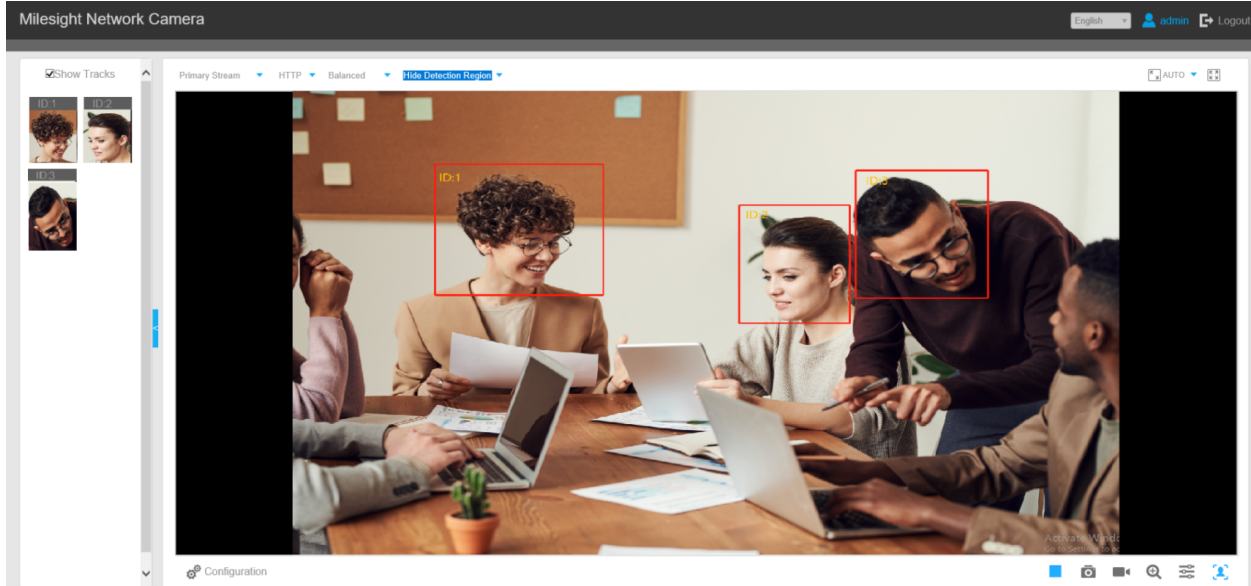

Advanced

Here you can enable Attribute Recognition and configure the attributes you want to detect. Or enable the Face Privacy Mode for Face Detection.

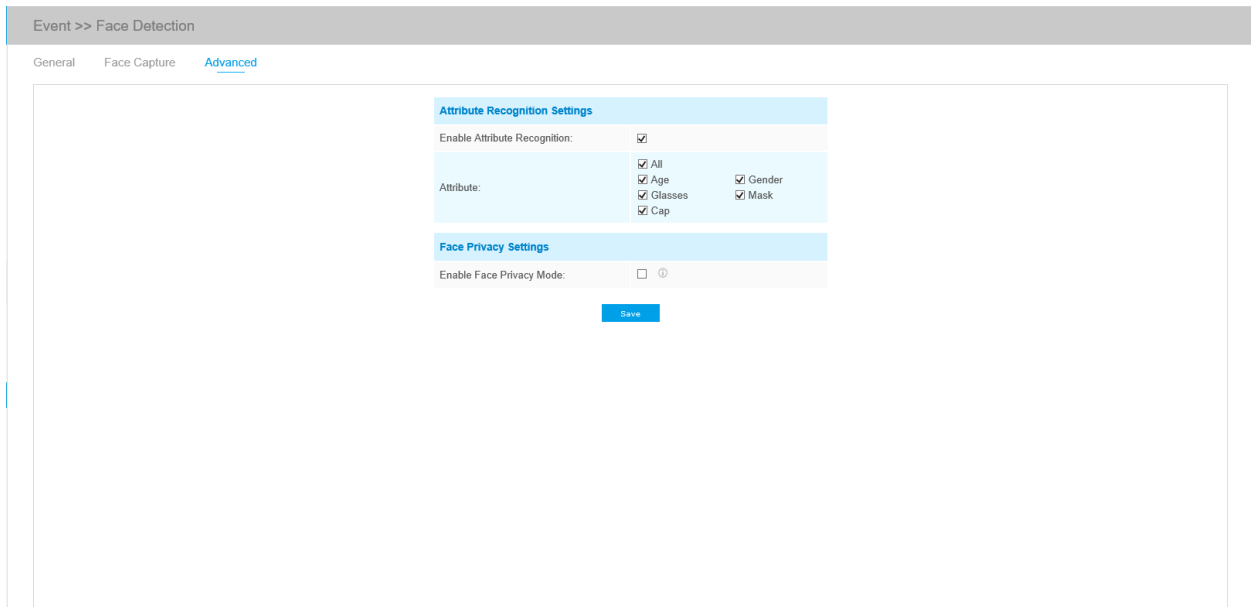

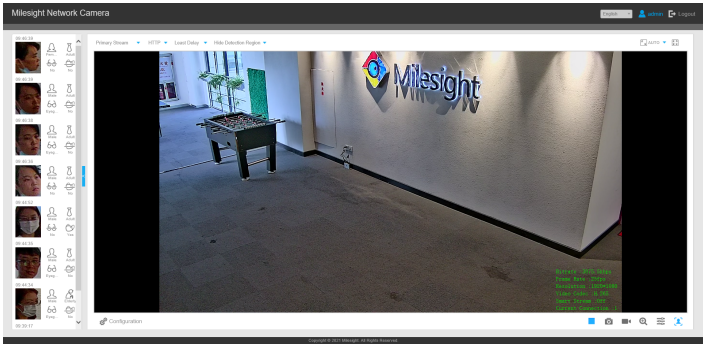



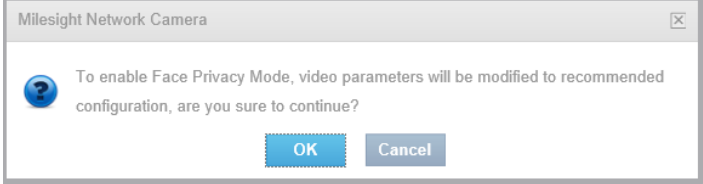
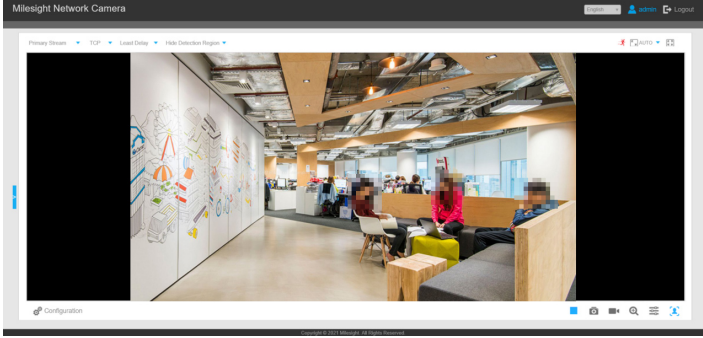

Table 46. Description of the buttons

Parameters	Function Introduction						
<p style="text-align: center;">Enable Attribute Recognition</p>	<p>When Attribute Recognition is enabled, the attributes of detected faces will be displayed on the left side of the Live View interface. The attributes include Age, Gender, Glasses, Mask and Cap. Attribute Recognition meets the needs of users in some special scenarios, which improves user experience.</p> <p> Note:</p> <ul style="list-style-type: none"> • Please make sure the face detection function is enabled. • Make sure the Capture Mode Option is set to Quality Priority. • Attribute Recognition function cannot be used together with Face Privacy function. • Make sure your camera model is MS-CXXX-XXC. (Except for LPR Camera Series) <div style="text-align: center;">  </div> <div style="text-align: center;"> <p>Capture Time:</p>  <table style="margin-left: 100px;"> <tr> <td>Gender: Male</td> <td>Age: Adult</td> </tr> <tr> <td>Glasses: Yes</td> <td>Mask: Yes</td> </tr> <tr> <td>Cap: No</td> <td></td> </tr> </table> </div>	Gender: Male	Age: Adult	Glasses: Yes	Mask: Yes	Cap: No	
Gender: Male	Age: Adult						
Glasses: Yes	Mask: Yes						
Cap: No							
<p style="text-align: center;">Attribute</p>	<p>Users can choose the attributes as needed.</p> <p>All: Select or deselect all attributes in one click.</p> <p>Age: Recognize the age according the face, the types including Child (Age 0-17), Adult (Age 18-59), Elderly (Age more than 59).</p> <p>Gender: Recognize the gender according the face, the types including Male and Female.</p> <p>Glasses: Recognize whether person is wearing glasses or not.</p> <p>Mask: Recognize whether person is wearing mask or not.</p> <p>Cap: Recognize whether person is wearing cap or not.</p> <p> Note: Unrecognized or abnormally recognized attributes will be displayed as .</p>						

Parameters	Function Introduction
<p>Enable Face Privacy Mode</p>	<p>When Face Privacy Mode is enabled, the detected faces in the face detection area will be mosaic automatically. The size of the mosaic is related to that of the detected faces, and users can customize the size of the detected faces as needed. The Face Privacy function meets the needs of users in some special scenarios, which greatly protects people's portrait rights.</p> <p>Note:</p> <p>#Please make sure the face detection function is enabled. #To enable Face Privacy Mode, video parameters should be:</p> <ul style="list-style-type: none"> • H.265 video codec (all streams) • Primary Stream: 1080P@25fps • Secondary Stream: 704*576@25fps • Tertiary Stream: Disabled <p>You can change video parameters to recommended configuration in the pop up window:</p>  <p>#Face Capture/Face Detection Message Post/Attribute Recognition are not available in Face Privacy Mode. #Make sure your camera model is MS-CXXXX-XXC. (Except for LPR Camera Series)</p> 

5.7 LPR (Optional)

5.7.1 Live Video

Milesight LPR Camera supports professional LPR Live View interface , it can show the real-time license plate recognition results and display the snapshots of detected license plates ,which realizes a stand-alone LPR solution.

LPR mode of Live View interface (Non-AI Series)

Recognition Result: RT578N

No.	Time	License Plate	Plate Type	Vehicle Speed	Direction	Detection Region
6	2020-04-13 16:57:11	RT578N	Visitor	-	-	1
5	2020-04-13 16:57:10	NERB1118	Visitor	-	-	1
4	2020-04-13 16:57:05	NERB1118	Visitor	-	-	1
3	2020-04-13 16:57:02	NERB1111	Visitor	-	-	1
2	2020-04-13 16:57:02	NERB1118	Visitor	-	-	1
1	2020-04-13 16:57:01	NERB1111	Visitor	-	-	1

LPR mode of Live View interface (AI Series)

Recognition Result: RT578N

No.	Time	License Plate	Plate Type	Plate Color	Vehicle Type	Vehicle Color	Speed	Direction	Detection Region
6	2021-05-27 16:57:11	RT578N	Visitor	Yellow	Car	Black	000km/h	Approach	1
5	2021-05-27 16:56:10	NERB1118	Visitor	Black	Car	Blue	110km/h	Away	2
4	2021-05-27 16:54:31	08F01204	Visitor	White	Truck	White	000km/h	Approach	2
3	2021-05-27 16:52:35	08F01482	Visitor	Blue	Car	Black	000km/h	Away	1
2	2021-05-27 16:51:11	8849270	Visitor	White	Car	Gray	200km/h	Approach	1
1	2021-05-27 16:47:41	8426844	Visitor	Black	Motorcycle	Black	200km/h	Approach	1

Note: For Snapshot/Recording (📷/🎥), you can click to capture/record the current image/video, but only when you using the IE browser with plugin, it will automatically be saved to the configured path on your PC and pop up the corresponding folder. If you using the Chrome/Firefox/

Safari/Edge browser in Plugin-Free Mode, it will not automatically pop up the corresponding folder to show you the details.

5.7.2 Settings

The LPR function will automatically detect and capture license plate in real time and compares to a predefined list, then takes appropriate action such as generating an alert once the license plate is on the predefined black list.

Note:

- LPR is optional for 12X AF Motorized Pro Bullet, Mini PoE PTZ Bullet, ABF Pro Box, Vandal-proof Motorized Mini Bullet, Motorized Pro Bullet Network Camera, Mini Bullet Network Camera.
- Currently we have three LPR versions, **LPR1**, **LPR2** and **LPR3**. LPR1 is for Asian regions, LPR2 is for European regions and the former Soviet Union and LPR3 is for Korea.
- There is only Basic Event under Event Tab for LPR cameras.

General

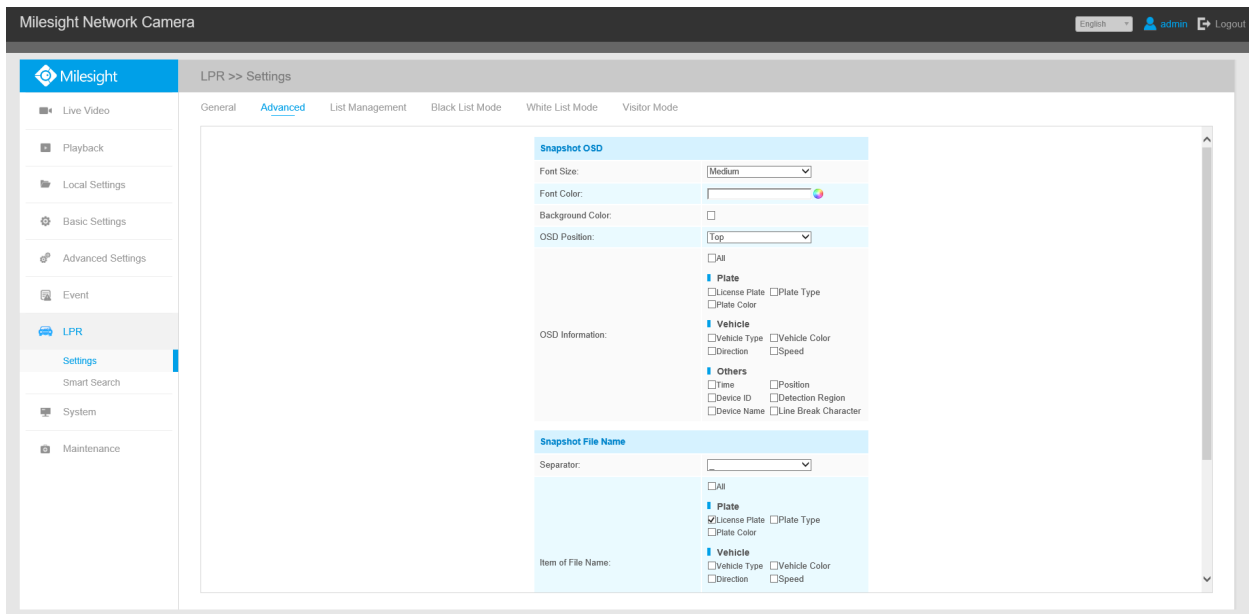

Step1: Enter the license and click Save. When the License Status changes to Valid, the camera can start detecting the license plates.

Enable License Plate Recognition:	<input checked="" type="checkbox"/>
License:	7325220EC7B6C181B38A
License Status:	Valid
Processing Resolution:	1280*720



 **Note:** Only LPR2 and LPR3 need to enter a license to activate the LPR function.

Step2: The LPR Night Mode supports the optimal LPR night recognition effect by adjusting different parameter levels. You can choose Customize to set effective time manually, or choose Auto Mode which can automatically switch to night mode according to illumination intensity.

Customize Mode

Image Settings	
Enable LPR Night Mode:	<input checked="" type="checkbox"/>
Effective Time:	Customize
Start Time:	18 00
End Time:	06 00
Level:	

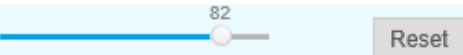

Auto Mode

Image Settings	
Enable LPR Night Mode:	<input checked="" type="checkbox"/>
Effective Time:	Auto Mode
Day to Night Value:	
Night to Day Value:	
IR Light Sensor Value:	100 
Level:	

Step3: Check the checkbox “Enable License Plate Recognition”, you can draw the screen to select area interested.

Table 47. Description of the buttons

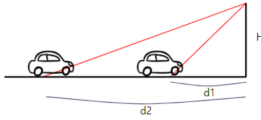
Parameters	Function Introduction
License (Only for LPR2 and LPR3)	Generated by camera's information
License Status (Only for LPR2 and LPR3)	Show present license status, including Valid and Invalid .
Processing Resolution	Resolution of the stream for LPR analysis, including 1920*1280, 1280*720, 640*360, 320*176.
Country/ Region (Only for LPR1)	Select country/ region to detect the license plate.
Effective Region Settings (Only for PTZ series)	Normal: configure the LPR detection regions for the current area. Advanced: configure different LPR detection regions for different PTZ presets(Only support Preset 1~4 so far).
Enable Day/Night Detection Mode (Only for LPR3)	With this option enabled, the camera will enable different detection modes according to Day/Night mode.

Parameters	Function Introduction																				
<p>Enable Vehicle Speed Detection (Only for LPR3)</p>	<p>With this option enabled, the camera will detect the vehicle speed and display results on the Smart Search interface.</p> <p>You need to draw two lines(Line1 and Line2) on the live view, and fill in Camera Installation Height, Horizontal Distance1 and Horizontal Distance2, camera will combine the lines you draw and the data filled to calculate the vehicle speed.</p> <p>Camera Installation Height: real height of camera.</p> <p>Horizontal Distance1: real distance between camera pole and line1.</p> <p>Horizontal Distance2: real distance between camera pole and line2.</p> <p>Speed of vehicle</p> <ul style="list-style-type: none"> Requirement <ul style="list-style-type: none"> Real height of camera (H) (unit: meter) Real distance between camera pole and line (d1, d2) (unit: meter) Pixel position of each line (y1, y2) (unit: pixel) To be changed UI <ul style="list-style-type: none"> Drawable two lines Edit boxes to input camera height and distance of each line  																				
<p>Add</p>	<p>Draw the screen to select the area interested, then click "Add"button to add the area, only four recognition areas can be added.</p> <p>You can edit the name of the area or delete the area in the list below.</p> <table border="1" data-bbox="618 1184 1382 1373"> <thead> <tr> <th>ID</th> <th>Name</th> <th>Edit</th> <th>Delete</th> </tr> </thead> <tbody> <tr> <td>1</td> <td>ROI_1</td> <td></td> <td></td> </tr> <tr> <td>2</td> <td>ROI_2</td> <td></td> <td></td> </tr> <tr> <td>3</td> <td>ROI_3</td> <td></td> <td></td> </tr> <tr> <td>4</td> <td>ROI_4</td> <td></td> <td></td> </tr> </tbody> </table> <p> Note: Only license plates larger than 150 pixels can be recognized.</p>	ID	Name	Edit	Delete	1	ROI_1			2	ROI_2			3	ROI_3			4	ROI_4		
ID	Name	Edit	Delete																		
1	ROI_1																				
2	ROI_2																				
3	ROI_3																				
4	ROI_4																				
<p>Clear</p>	<p>Click the "Clear" button to clear the area being drawn.</p>																				
<p>Delete All</p>	<p>Click the "Delete All" button to delete all the added areas.</p>																				

Step4: Schedule Settings. You can draw the schedule by clicking Edit button.

Schedule Settings

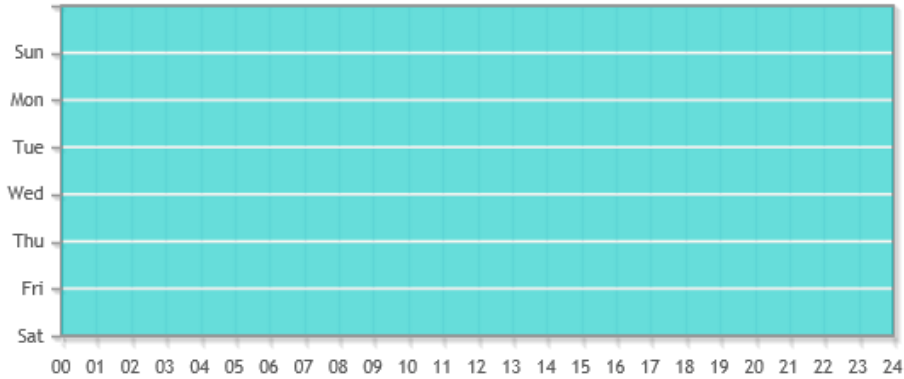

Edit

Step5: Set Detection Settings and LPR Message Post Settings.

Detection Settings

Detection Trigger:	Always
Confidence Level:	4
Repeat Plate Checktime:	0 millisecond (0~60000ms)
Features Identification:	<input type="checkbox"/> All <input type="checkbox"/> Direction <input type="checkbox"/> Detection Region <input type="checkbox"/> Region

LPR Message Post Settings

Enable LPR Message Post:	<input checked="" type="checkbox"/>
Post Type:	HTTP
HTTP Method:	Post
Snapshot Type:	All
HTTP Notification URL:	
User Name:	
Password:	

Table 48. Description of the buttons

Parameters	Function Introduction
Detection Trigger	<p>Always: in this mode, camera will always detect license plates.</p> <p>Alarm Input: in this mode, camera will only detect license plates during Alarm Input is being triggered.</p>
Confidence Level (Only for LPR1 and LPR2)	<p>You can set the confidence level from 1 to 10.</p> <p>When the confidence level of the license plate is higher than the set confidence level, it will push the license plate image to the Smart Search interface.</p>
Repeat Plate Checktime	<p>Set the time interval for repeatedly reading license plates to effectively avoid duplicate identification of parking vehicles.</p> <p>You can set Repeat Plate Checktime from 0 to 60min or 0 to 60000ms.</p>
Feature Identification	<p>Check Region(Only for LPR2), Direction Region, Direction or All to enable Feature Identification, it will display the corresponding information on the Smart Search interface.</p>
Enable LPR Message Post	<p>Check the checkbox to enable LPR Message Post. It will push information to some third-party devices or software that are compatible with ours.</p>
Post Type	<p>Information can be pushed by RTSP, TCP or HTTP.</p>
HTTP Method	<p>There are two HTTP push methods, including Post and Get.</p>
Snapshot Type	<p>Three kinds of snapshot can be chosen: All, License Plate and Full Snapshot. When you choose All, License Plate Snapshot and Full Snapshot will be pushed.</p> <p>Note: This option is available just for Post HTTP Method.</p>
HTTP Notification URL	<p>LPR camera can use the API URL to send LPR information to back-end devices when the license plate is recognized. API URL format fills as below:</p> <p>http://IP:Port/api/lpr?</p>
User Name	<p>Receiver name</p>
Password	<p>Receiver Password</p>

 **Note:** License Plate Serial Format function supports formulating identification rules and can automatically do further processing, filter license plates in non-compliant formats to achieve more intelligent and accurate license plate recognition.

Settings

Add
Delete All

ID	License Plate Character Count	License Plate Serial Format	Enable	Edit	Delete
0	ALL	*	<input type="checkbox"/>		
1	6	AA111A	<input checked="" type="checkbox"/>		
2	7	AA111A*	<input checked="" type="checkbox"/>		

Filter out results with incorrect character count
 A - Letters Only
 1 - Numbers Only
 * - Unrestricted Type
 Example: AA1111*

Save

Advanced

In the interface, you can set display information on snapshot of license plate recognition, and also customize the file name of snapshots which are uploaded via FTP or Email or stored on local LPR Picture File Path.

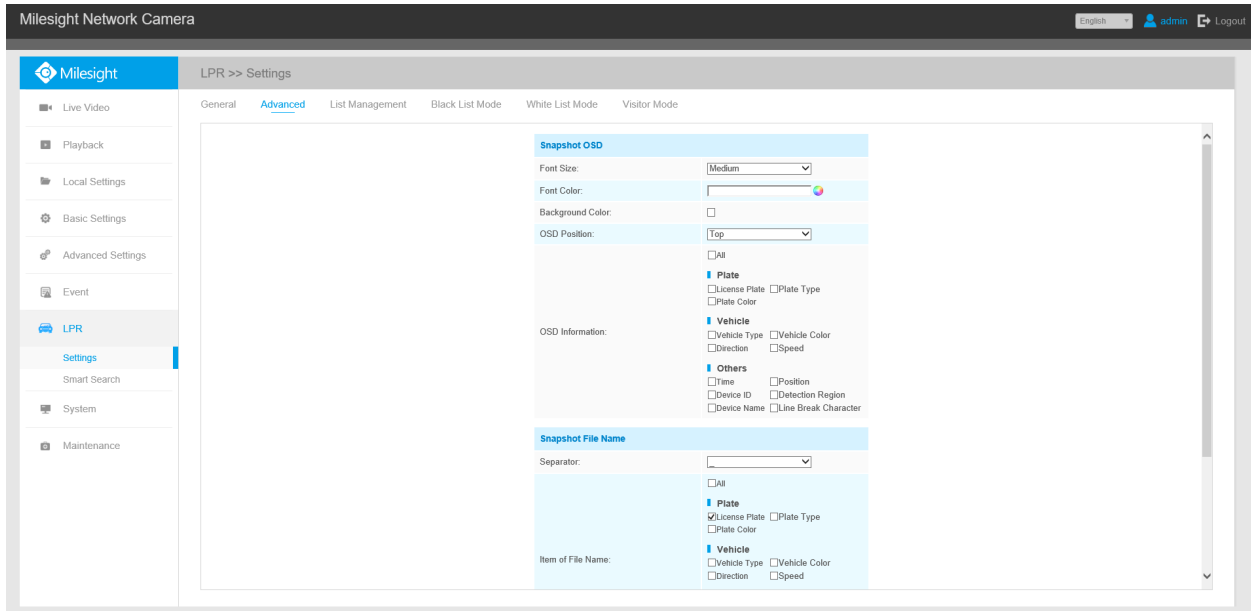







Table 49. Description of the buttons

Parameters	Function Introduction
Font Size	Small/Medium/Large are available for OSD information.  Note: Snapshot OSD font size and Image OSD font size are corresponded.
Font Color	Enable to set different color for OSD information.  Note: Snapshot OSD font color and Image OSD font color are corresponded.
Background Color	Check the checkbox to select background color of snapshot OSD information.  Note: Background color cannot be the same with font color.
OSD Position	Check the checkbox to show OSD information position.

Parameters	Function Introduction
<p>OSD Information</p>	<p>Customize the OSD content. You can set OSD Information as shown below:</p> <div data-bbox="617 403 1406 814" style="border: 1px solid #ccc; padding: 10px; margin: 10px 0;"> <p>OSD Information:</p> <ul style="list-style-type: none"> <input type="checkbox"/> All Plate <ul style="list-style-type: none"> <input type="checkbox"/> License Plate <input type="checkbox"/> Plate Type <input type="checkbox"/> Plate Color Vehicle <ul style="list-style-type: none"> <input type="checkbox"/> Vehicle Type <input type="checkbox"/> Vehicle Color <input type="checkbox"/> Direction <input type="checkbox"/> Speed Others <ul style="list-style-type: none"> <input type="checkbox"/> Time <input type="checkbox"/> Position <input type="checkbox"/> Device ID <input type="checkbox"/> Detection Region <input type="checkbox"/> Device Name <input type="checkbox"/> Line Break Character </div> <p>When license plate is recognized and the alarm is triggered, the snapshot of license plate recognition will show as below:</p> <div data-bbox="613 930 1409 1360" style="border: 1px solid #ccc; padding: 10px; margin: 10px 0;"> <p>2020-10-10 20:04:09 RT578N Position</p>  </div>
<p>Separator</p>	<p>“-”, “_” and Space are available for File Name Separator format. The default separator is “-”.</p>

Parameters	Function Introduction
<p style="text-align: center;">Item of File Name</p>	<p>You can customize the snapshot file name according to items chosen.</p> <div style="border: 1px solid #ccc; background-color: #e0f2f1; padding: 10px;"> <p>Item of File Name:</p> <p><input type="checkbox"/> All</p> <p>Plate</p> <p><input checked="" type="checkbox"/> License Plate <input type="checkbox"/> Plate Type</p> <p><input type="checkbox"/> Plate Color</p> <p>Vehicle</p> <p><input type="checkbox"/> Vehicle Type <input type="checkbox"/> Vehicle Color</p> <p><input type="checkbox"/> Direction <input type="checkbox"/> Speed</p> <p>Others</p> <p><input checked="" type="checkbox"/> Time <input type="checkbox"/> Position</p> <p><input type="checkbox"/> Device ID <input type="checkbox"/> Detection Region</p> <p><input type="checkbox"/> Device Name</p> </div>

Each time when an item is checked, the list will add the item row, including the item name and sorting operation. You can click  and  button to sort these items, and choose separator to connect these items name. Also, the content of Position and Device ID items can be customized. When you check all items, the function interface will show as below:

Snapshot File Name	
Separator:	-
Item of File Name:	<input checked="" type="checkbox"/> All <input checked="" type="checkbox"/> Time <input checked="" type="checkbox"/> License Plate <input checked="" type="checkbox"/> Plate Type <input checked="" type="checkbox"/> Vehicle Speed <input checked="" type="checkbox"/> Direction <input checked="" type="checkbox"/> Detection Region <input checked="" type="checkbox"/> Position <input checked="" type="checkbox"/> Device Name <input checked="" type="checkbox"/> Device ID
Item of File Name	Sorting
Plate Type	⇅ ⇅
Vehicle Speed	⇅ ⇅
License Plate	⇅ ⇅
Direction	⇅ ⇅
Detection Region	⇅ ⇅
Position: <input type="text" value="Position"/>	⇅ ⇅
Device Name	⇅ ⇅
Time	⇅ ⇅
Device ID: <input type="text" value="Device ID"/>	⇅ ⇅

Note: The file name of full-snapshot will be preceded by a number of 4.

 **Note:** You need to check at least one item.

For example, you can choose items, separator and items sorting as below:

Snapshot File Name

Separator:

Item of File Name:

All
 Time
 License Plate

Plate Type
 Vehicle Speed

Direction
 Detection Region

Position
 Device Name

Device ID

Item of File Name	Sorting
Time	⇅ ⇅
License Plate	⇅ ⇅

Note: The file name of full-snapshot will be preceded by a number of 4.

Save

Once license plate is recognized, and the snapshot will be uploaded via FTP or Email or stored on your local LPR Picture File Path. Then, You can see the snapshot file name which you customize as shown below:

Full-snapshot Recognized successfully



420201116021729_##528N

Full-snapshot Recognized failed



420201116021729_RT528N

License plate snapshot Recognized successfully



20201116021729_RT528N

License plate snapshot Recognized failed



20201116021729_##528N

Note:

- If the item checked is not recognized successfully, then the item will be displayed with the specific symbol “#”.
- The file name of full-snapshot will be preceded by a number of 4.

List Management

Add the license plates to this interface as Black or White type (Black/White List), and then you can set the alarm action for these license plates in the corresponding black list mode or white list

mode interface. When these license plates are detected, the camera will respond accordingly to your settings.

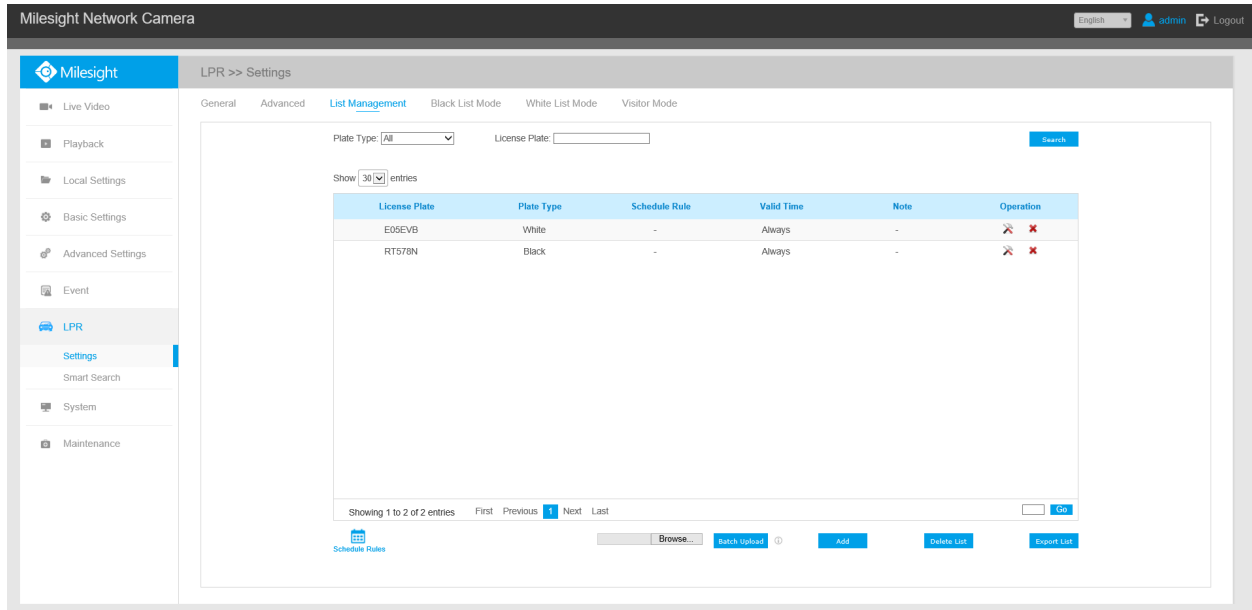

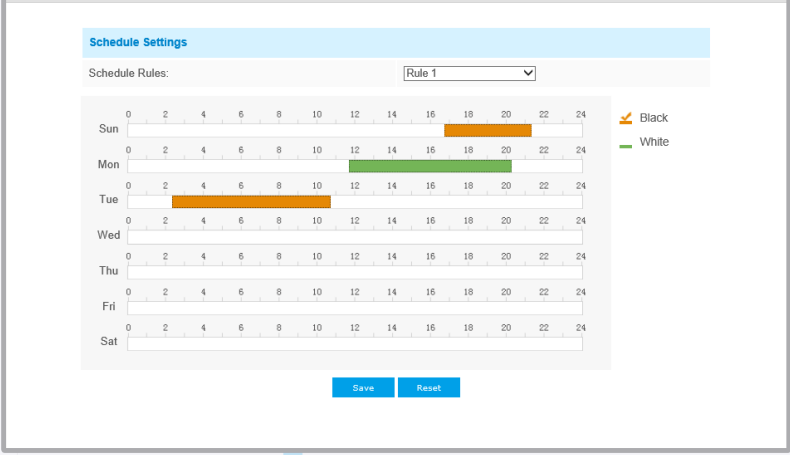
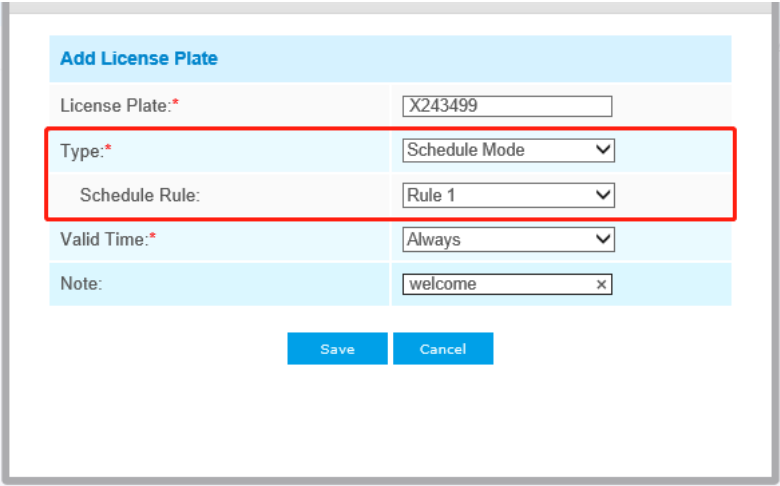



Table 50. Description of the buttons

Parameters	Function Introduction
<p>Add License Plate</p>	<p>Select the license plate type as black or white, enter the license plate, click the "Add" button, the license plate will be added successfully.</p> <div data-bbox="586 1182 1382 1671" style="border: 1px solid gray; padding: 10px;"> <p>Add License Plate</p> <p>License Plate:* <input type="text" value="X243499"/></p> <p>Type:* <input type="text" value="Black"/></p> <p>Valid Time:* <input type="text" value="Customized"/></p> <p>Start Time: <input type="text" value="2021-06-10 00:00:00"/></p> <p>End Time: <input type="text" value="2021-06-10 23:59:59"/></p> <p>Note: <input type="text" value="welcome"/></p> <p style="text-align: center;"> <input type="button" value="Save"/> <input type="button" value="Cancel"/> </p> </div>

Parameters	Function Introduction
Batch Upload	<p>You can add a csv form with the license plate you want to add, click the "Browse" button to import the form to this interface, click the "Upload" button, the license plates will be added successfully.</p> <p> Note: You can first download the template as a reference in this interface.</p>
List Search	<p>Select Plate Type or directly enter the license plate number, click the "Search" button, the corresponding license plate will be displayed in the list below.</p>
Export List	<p>Click the "Export List" button to export the license plate in the current list to a csv form locally.</p>
Delete List	<p>Click the "Delete List" button to delete all the license plate in the current list.</p>

Parameters	Function Introduction
<p style="text-align: center;">Schedule Rules</p>	<p>Click the "Schedule Rules" button to customize a rule.</p>  <p>And then set the license plate to Schedule Mode and choose a custom schedule rule that can configure the license plate as Black List or White List at different times.</p>  <p> Note: Support setting up to 4 Schedule Rules for Schedule Mode.</p>

 **Note:** It supports adding 1000 Black List and White List.

Black List Mode

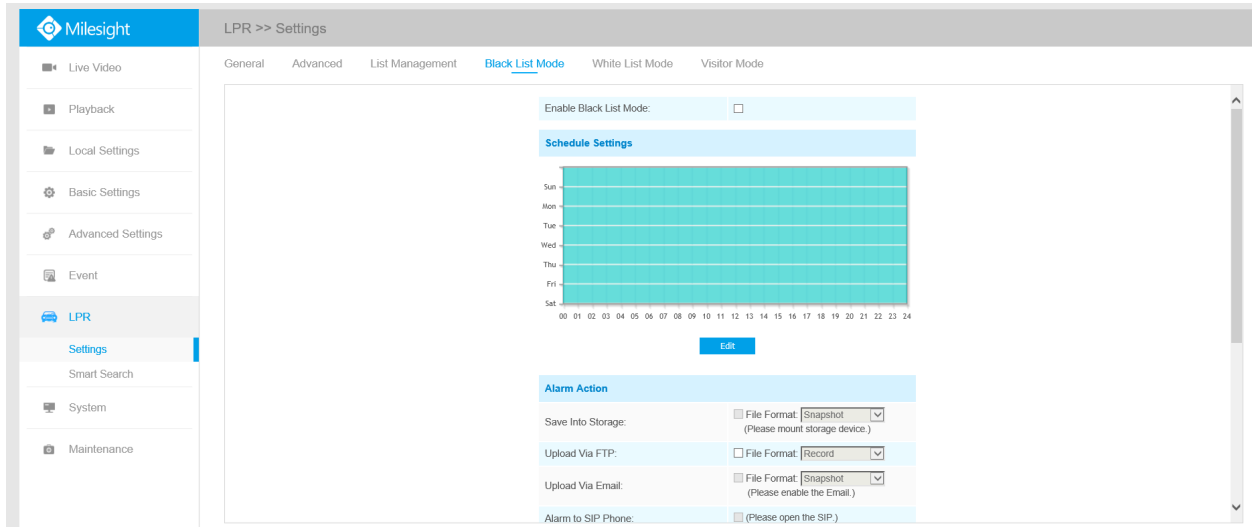

Step1: Check the checkbox to enable Black List Mode.

Step2: Schedule Settings. You can draw the schedule by clicking Edit button.

Step3: Set alarm action.

Alarm Action	
Save Into Storage:	<input type="checkbox"/> File Format: Snapshot ▼ (Please mount storage device.)
Upload Via FTP:	<input type="checkbox"/> File Format: Record ▼
Upload Via Email:	<input type="checkbox"/> File Format: Snapshot ▼ (Please enable the Email.)
Alarm to SIP Phone:	<input type="checkbox"/> (Please open the SIP.)
HTTP Notification:	<input type="checkbox"/>

Step4: Set alarm settings.

Alarm Setting	
Record Video Sections:	5 seconds
Snapshot Type:	License Plate
Snapshot:	1
Snapshot Interval:	1 second
Email Triggered Interval:	Auto
External Output Action Time:	30 seconds
Play Audio Interval:	Auto

After that, when a license plate marked as “black” is detected, the camera will respond accordingly to your settings.

White List Mode

The screenshot displays the Milesight LPR Settings page, specifically the White List Mode configuration. The interface includes a sidebar with navigation options like Live Video, Playback, Local Settings, Basic Settings, Advanced Settings, Event, LPR, Settings, Smart Search, System, and Maintenance. The main content area is titled 'LPR >> Settings' and has tabs for General, Advanced, List Management, Black List Mode, White List Mode (selected), and Visitor Mode. The White List Mode section contains the following settings:

- Enable White List Mode:** A checkbox that is currently unchecked.
- Schedule Settings:** A calendar grid showing days of the week (Sun to Sat) and hours (00 to 24). The grid is currently empty, and an 'Edit' button is located below it.
- Alarm Action:** A section with four options:
 - Save Into Storage:** A checkbox that is unchecked, with a 'File Format' dropdown set to 'Snapshot' and a note '(Please mount storage device.)'.
 - Upload Via FTP:** A checkbox that is unchecked, with a 'File Format' dropdown set to 'Record'.
 - Upload Via Email:** A checkbox that is unchecked, with a 'File Format' dropdown set to 'Snapshot' and a note '(Please enable the Email.)'.
 - Alarm to SIP Phone:** A checkbox that is unchecked, with a note '(Please open the SIP.)'.

Step1: Check the checkbox to enable White List Mode.

Step2: Schedule Settings. You can draw the schedule by clicking Edit button.

Step3: Set alarm action.

Alarm Action	
Save Into Storage:	<input type="checkbox"/> File Format: <input type="text" value="Snapshot"/> <input type="button" value="v"/> (Please mount storage device.)
Upload Via FTP:	<input type="checkbox"/> File Format: <input type="text" value="Record"/> <input type="button" value="v"/>
Upload Via Email:	<input type="checkbox"/> File Format: <input type="text" value="Snapshot"/> <input type="button" value="v"/> (Please enable the Email.)
Alarm to SIP Phone:	<input type="checkbox"/> (Please open the SIP.)
HTTP Notification:	<input type="checkbox"/>

Step4: Set alarm settings.

Alarm Setting	
Record Video Sections:	<input type="text" value="5 seconds"/> <input type="button" value="v"/>
Snapshot Type:	<input type="text" value="License Plate"/> <input type="button" value="v"/>
Snapshot:	<input type="text" value="1"/> <input type="button" value="v"/>
Snapshot Interval:	<input type="text" value="1"/> <input type="text" value="second"/> <input type="button" value="v"/>
Email Triggered Interval:	<input type="text" value="Auto"/> <input type="button" value="v"/>
External Output Action Time:	<input type="text" value="30 seconds"/> <input type="button" value="v"/>
Play Audio Interval:	<input type="text" value="Auto"/> <input type="button" value="v"/>

After that, when a license plate marked as “White” is detected, the camera will respond accordingly to your settings.

Visitor Mode

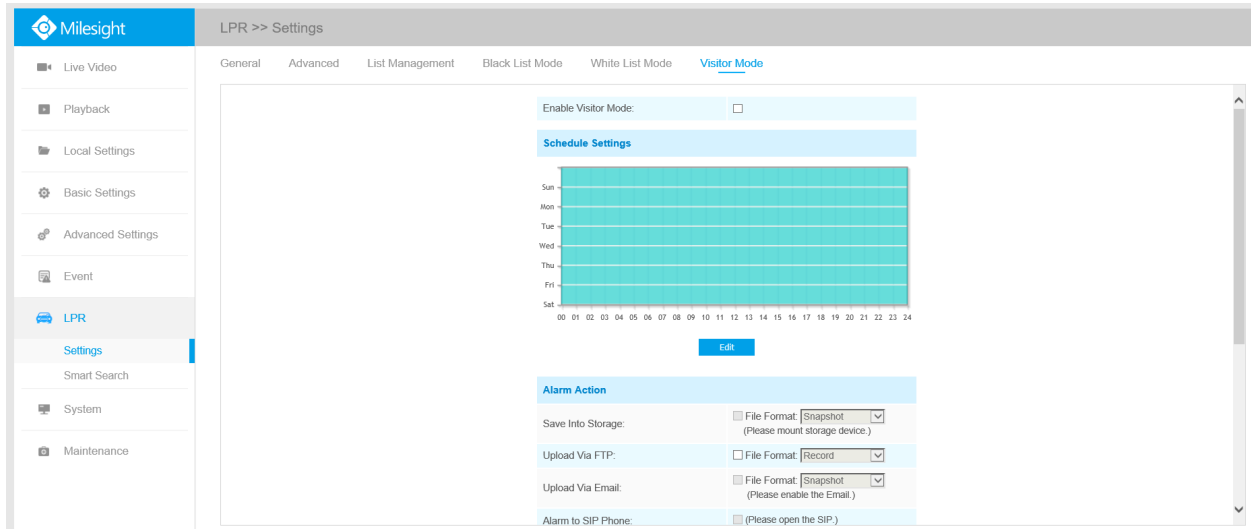

Step1: Check the checkbox to enable Visitor Mode.

Step2: Schedule Settings. You can draw the schedule by clicking Edit button.

Step3: Set alarm action.

Alarm Action	
Save Into Storage:	<input type="checkbox"/> File Format: Snapshot ▼ (Please mount storage device.)
Upload Via FTP:	<input type="checkbox"/> File Format: Record ▼
Upload Via Email:	<input type="checkbox"/> File Format: Snapshot ▼ (Please enable the Email.)
Alarm to SIP Phone:	<input type="checkbox"/> (Please open the SIP.)
HTTP Notification:	<input type="checkbox"/>

Step4: Set alarm settings.

Alarm Setting	
Record Video Sections:	5 seconds
Snapshot Type:	License Plate
Snapshot:	1
Snapshot Interval:	1 second
Email Triggered Interval:	Auto
External Output Action Time:	30 seconds
Play Audio Interval:	Auto

After that, when a license plate that is not marked as "Black" or "White" is detected, the camera will respond accordingly to your settings.

5.7.3 Smart Search

The real-time detection results will be displayed on the right side of Smart Search page, including detected time, live screenshot, and license plate.

Step1: Select Plate Type or directly enter the license plate number and then select Start Time and End Time. The related license plate information will be displayed as below by one click on the “**Search**” button.

The screenshot displays the 'Smart Search' interface of the Milesight Network Camera. The top navigation bar includes 'Milesight Network Camera', language settings (English), user 'admin', and a 'Logout' button. The left sidebar contains navigation options: Live Video, Playback, Local Settings, Basic Settings, Advanced Settings, Event, LPR (selected), Settings, System, and Maintenance. The main content area is titled 'LPR >> Smart Search' and contains a 'Smart Search' section with various filters: Plate Type (All), License Plate (input field), Speed (All), Direction (All), Start Time (2021-05-01 00:00:00), End Time (2021-05-27 23:59:59), Plate Color (All), Vehicle Type (All), and Vehicle Color (All). A 'Search' button is located to the right of these filters. Below the filters, there is a 'Fold' button and a live video feed of a car with license plate RT-578-N. To the right of the video feed is a grid of license plate images with their corresponding timestamps. The bottom of the interface shows a list of search results with details like Time, License Plate, Plate Type, Vehicle Type, Speed, Direction, and Detection Region.

 **Note:**

- It supports displaying 4,000 logs.
- Only when there is a SD Card or NAS has been set on the storage management , then the logs can be stored and show on Smart Search page.
- For Plate Color/Vehicle Color Recognition and Vehicle Type Classification, please make sure your model is MS-CXXXX-XXC.

Step2: Click on the thumbnail photo under the LPR Logs, then the license plate details will be shown as below :

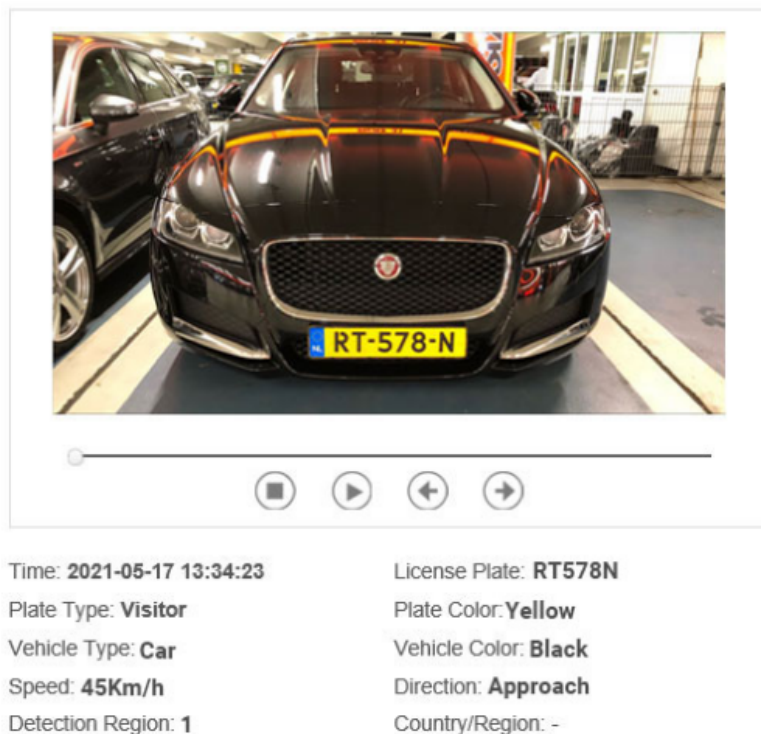

Time: 2021-05-17 13:34:23	License Plate: RT578N
Plate Type: Visitor	Plate Color: Yellow
Vehicle Type: Car	Vehicle Color: Black
Speed: 45Km/h	Direction: Approach
Detection Region: 1	Country/Region: -

Step3: Click the "**Export**" or "**Export All**" button to export the desired files in the current list to a local folder.

Export

Export File: Plate List Video Picture
 Plate List(With pictures)

Video File Format:

Step4: Click the "**Auto Export**" button to automatically export the logs to FTP, Email or Storage.

Log Settings

Enable Auto Export Logs:

Day:

Time:

Export Time Range:

Export to: FTP Email Storage

5.8 System

All information about the hardware and software of the camera can be checked on this page.

System	
Device Name:	<input type="text" value="Network Camera"/>
Product Model:	MS-C2942-B
Hardware Version:	V1.2
Software Version:	40.7.0.78
MAC Address:	1C:C3:16:23:8D:13
Device Information:	SD010ES2p0N6
Alarm Input:	2
Alarm Output:	2
Uptime:	4 days 17 minutes
QR Code:	 <p>Please scan this QR code on App to get a remote view.</p>
<input type="button" value="Save"/>	

Table 51. Description of the buttons

Parameters	Function Introduction
Device Name	The device name can be customized. It will be seen in file names of video files
Product Model	The product model of the camera
Hardware Version	The hardware version of the camera
Software Version	The software version of the camera can be upgraded
MAC Address	Media Access Control address

Parameters	Function Introduction
Device Information	The device information, including information about alarm I/O and clipper chip
Alarm Input	The number of Alarm Input interface
Alarm Output	The number of Alarm Output interface
Up Time	The elapsed time since the last restarted of the device



 **Note:** The Alarm Input/Alarm Output will appear only when the camera have alarm input/output interface.



5.9 Maintenance

5.9.1 System Maintenance

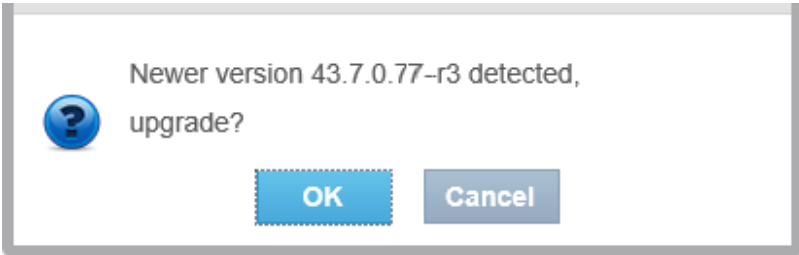
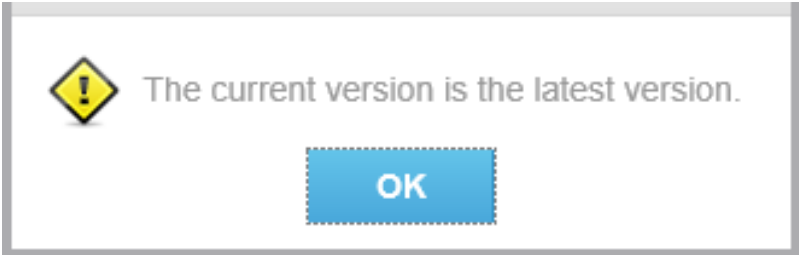
System Upgrade	
Software Version:	43.7.0.77
Local Upgrade:	<input type="text"/> <input type="button" value="Browse..."/> <input type="button" value="Upgrade"/> <input type="checkbox"/> Reset after Upgrading
Online Upgrade:	<input type="button" value="Check"/>
<p>Note: Do not disconnect the power of the device during the upgrade.</p>	
Maintenance	
Reset <input checked="" type="checkbox"/> Keep the IP Configuration <input checked="" type="checkbox"/> Keep the User Information	<input type="button" value="Reset"/>
Export Diagnose Information:	<input type="button" value="Export"/>
Export Config File:	<input type="button" value="Export"/>
Config File:	<input type="text"/> <input type="button" value="Browse..."/>
Import Config File:	<input type="button" value="Import"/>
Reboot	
Reboot the Device:	<input type="button" value="Reboot"/>

Table 52. Description of the buttons

Parameters	Function Introduction
System Upgrade	<p>Software Version: The software version of the camera.</p> <p>Local Upgrade: Click the "Browse" button and select the upgrading file, then click the "Upgrade" button to upgrade. After the system reboots successfully, the update is done.</p> <p>You can check "Reset after Upgrading" to reset the camera after upgrading it.</p> <p>Online Upgrade: Click the "Check" button to check the current latest firmware version on our website, and then click "OK" to upgrade to this version.</p> <p>It will prompt "The current version is the latest version" if your camera is already the latest version.</p> <div data-bbox="592 709 1386 961" style="border: 1px solid #ccc; padding: 10px; margin: 10px 0;">  <p>Newer version 43.7.0.77-r3 detected, upgrade?</p> <p>OK Cancel</p> </div> <p>It will prompt "The current version is the latest version" if your camera is already the latest version.</p> <div data-bbox="592 1077 1386 1329" style="border: 1px solid #ccc; padding: 10px; margin: 10px 0;">  <p>The current version is the latest version.</p> <p>OK</p> </div> <p> Note: Do not disconnect the power of the device during the update. The device will be restarted to complete the upgrading.</p>



Parameters	Function Introduction
<p style="text-align: center;">Maintenance</p>	<p>Reset settings: Click “Reset” button to reset the camera to factory default settings</p> <p>Keep the IP Configuration: Check this option to keep the IP configuration when resetting the camera.</p> <p>Keep the User information: Check this option to keep the user information when resetting the camera.</p> <p>Export Diagnose Information: Click this button to export logs and system information of the device operation status.</p> <p> Note: The file format is “.txt”.</p> <p>Export Config File: Click this button and a window will pop up as shown below:</p> <div data-bbox="594 762 1188 1159" style="border: 1px solid #ccc; padding: 10px; margin: 10px 0;"> <p style="text-align: center; border-bottom: 1px solid #ccc;">File Encryption Configuration ✕</p> <p style="text-align: center;">Input the encryption password:</p> <div style="border: 1px solid #ccc; height: 20px; width: 100%; margin-bottom: 5px;"></div> <p style="text-align: center;">Confirm:</p> <div style="border: 1px solid #ccc; height: 20px; width: 100%; margin-bottom: 10px;"></div> <div style="display: flex; justify-content: center; gap: 20px;"> Save Cancel </div> </div> <p>You need to enter and confirm password again, then click save button to export configuration file.</p> <p>Import Config File: Click this button, then a window will pop up and you can click "OK" to update the configuration.</p> <p>It will pop up a window to prompt "Input the password of config file" , then enter password and click save button to import configuration file.</p> <div data-bbox="594 1430 1188 1724" style="border: 1px solid #ccc; padding: 10px; margin: 10px 0;"> <p style="text-align: center; border-bottom: 1px solid #ccc;">File Decryption ✕</p> <p style="text-align: center;">Input the password of config file:</p> <div style="border: 1px solid #ccc; height: 20px; width: 100%; margin-bottom: 10px;"></div> <div style="display: flex; justify-content: center; gap: 20px;"> Save Cancel </div> </div> <p> Note: Export and import the same configuration file. Password must be the same.</p>

Parameters	Function Introduction
Reboot	Click "Reboot" button to restart the device immediately

5.9.2 Auto Reboot

Set the date and time to enable Auto Reboot function, the camera will reboot automatically according to the customized time in case that camera overload after running a long time.

Auto Reboot Settings

Enable Auto Reboot:	<input type="checkbox"/>
Day:	Everyday 
Time:	00:00:00 

Save

Chapter 6. Services

Milesight Technology Co., Ltd provides customers with timely and comprehensive technical support services. End-users can contact your local dealer to obtain technical support. Distributors and resellers can contact directly with Milesight for technical support.

Technical Support Mailbox: support@milesight.com

Web: <http://www.milesight.com>

Online Problem Submission System: <http://www.milesight.com/service/feedback.asp>

MILESIGHT USA

TEL: +1-800-561-0485

Add: 7509 N.W. 36th Street, Miami, Florida 33166, USA

MILESIGHT KOREA

TEL: +82-2-839-3335

Add: 925, Anyang SK V1 Center, LS-ro 116beon-gil, Dongan-gu, Anyang-si, Korea

MILESIGHT CHINA

TEL: +86-592-5922772

Add: No.23 Wanghai Road,2nd Software Park, Xiamen, China