



Network Camera User Manual

V7.19

Thank you for purchasing our product. If there is any questions or requests, please do not hesitate to contact your dealer.

This manual is applicable to the Milesight H.265 Network Camera, series shown as follows, except where otherwise indicated.

Milesight H.265 Network Camera				
Type Megapixel	2MP	2MP	5MP	4K
IR Mini Dome Network Camera	—	MS-C2983-(R)(T)(Q)PB	MS-C5383-(H)PB	MS-C8183-(H)PB
Vandal-proof Mini Dome Network Camera	—	MS-C2973-(R)PB	MS-C5373-(H)PB	MS-C8173-PB
Weather-proof Mini Dome Network Camera	—	MS-C2975-PB	MS-C5375-PB	—
AF Motorized Mini Dome Network Camera	—	MS-C2975-EPB	MS-C5375-EPB	—
Mini Bullet Network Camera	—	MS-C2963-(R)PB/ MS-C2963-(Q)(R)LPB	MS-C5363-(H)PB	MS-C8163-(H)PB
Vandal-proof Mini Bullet Network Camera	—	MS-C2964-(R)PB	MS-C5364-(H)PB	MS-C8164-PB
Motorized Mini Bullet Network Camera	—	MS-C2963-(R)F(I)PB	MS-C5363-F(I)PB	—
Vandal-proof Motorized Mini Bullet Network Camera	MS-C2864-(R)F(I)PB	MS-C2964-(Q)(T)(R)F(I)PB/ MS-C2964-(Q)(R)F(I)LPB	MS-C5364-(H)F(I)PB	MS-C8264-F(I)PB
180° Panoramic Mini Bullet Network Camera	—	—	MS-C5365-PB	MS-C8165-PB
180° Panoramic Mini Dome Network Camera	—	—	MS-C5376-PB	MS-C8176-(H)PB
Motorized Pro Bullet Network Camera	MS-C2862-(R)F(I)PB	MS-C2962-(Q)(T)(R)F(I)PB/ MS-C2962-RF(I)APB/ MS-C2962-(Q)(R)F(I)LPB	MS-C5362-(H)F(I)PB	MS-C8162-(H)F(I)PB/ MS-C8262-F(I)PB
Motorized Pro Dome Network Camera	MS-C2872-(R)F(I)PB	MS-C2972-(Q)(T)(R)F(I)PB/ MS-C2972-RF(I)APB	MS-C5372-(H)F(I)PB	MS-C8172-(H)F(I)PB/ MS-C8272-F(I)PB
AI Motorized Pro Bullet Network Camera	—	MS-C2962-RF(I)PC	MS-C5362-F(I)PC	—
AI Motorized Pro Dome Network Camera	—	MS-C2972-RF(I)PC	MS-C5372-F(I)PC	—
12x AF Motorized Pro Bullet Network Camera	—	MS-C2962-(Q)(T)(R)EPB/ MS-C2962-REAPB/ MS-C2962-(Q)(R)ELPB	MS-C5362-(H)EPB	—
(ABF) Pro Box Network Camera	MS-C2851-(R(E))PB	MS-C2951-(Q)(T)(R)(E)PB/ MS-C2951-R(E)APB/ MS-C2951-(Q)(R)(E)LPB	MS-C5351-(H)PB	MS-C8151-(H)PB/ MS-C8251-PB

This Manual explains how to use and manage Milesight network cameras on your network. Previous experience of networking will be of use when using the products. Please read this manual carefully before operation and retain it for future reference.

This manual may contain several technically incorrect places or printing errors, and the content is subject to change without notice. The updates will be added into the new version of this manual. We will readily improve or update the products or procedures described in the manual.

Copyright Statement

This manual may not be reproduced in any form or by any means to create any derivative such as translation, transformation, or adaptation without the prior written permission of Milesight Technology Co., Ltd.(Hereinafter referred to as Milesight).

Milesight reserves the right to change this manual and the specifications without prior notice. The latest specifications and user documentation for all Milesight products are available on our official website www.milesight.com

Industry Canada ICES-003 Compliance:

This Class B digital apparatus complies with Canadian ICES-003.

Cet appareil numérique de la classe B est conforme a la norme NMB-003 du Canada.





Safety Instruction

These instructions are intended to ensure that user can use the product correctly to avoid danger or property loss. The precaution measures are divided into “Warnings” and “Cautions”

Warnings: Serious injury or death may be caused if any of these warnings is neglected.

Cautions: Injury or equipment damage may be caused if any of these cautions are neglected.

	
<p>Warnings: Please follow these safeguards to prevent injury or death.</p>	<p>Cautions: Please follow these safeguards to prevent potential injury or material damage.</p>



Warnings

- ◆ This installation must be conducted by a qualified service person and should strictly comply with the electrical safety regulations of the local region
- ◆ To avoid risk of fire and electric shock, do keep the product away from rain and moisture before installed.
- ◆ Do not touch components such as heat sinks, power regulators, and processors, which may be hot

- ◆ Source with DC 12V or PoE
- ◆ Please make sure the plug is firmly inserted into the power socket
- ◆ When the product is installed on a wall or ceiling, the device should be firmly fixed
- ◆ If the product does not work properly, please contact your dealer. Never attempt to disassemble the camera by yourself



Cautions

- ◆ Make sure that the power supply voltage is correct before using the camera
- ◆ Do not store or install the device in extremely hot or cold temperatures, dusty or damp locations, and do not expose it to high electromagnetic radiation
- ◆ Only use components and parts recommended by manufacturer
- ◆ Do not drop the camera or subject it to physical shock
- ◆ To prevent heat accumulation, do not block air circulation around the camera
- ◆ Laser beams may damage image sensors. The surface of image sensors should not be exposed to where a laser beam equipment is used
- ◆ Use a blower to remove dust from the lens cover
- ◆ Use a soft, dry cloth to clean the surface of the camera. Stubborn stains can be removed using a soft cloth dampened with a small quantity of detergent solution, then wipe dry
- ◆ Do not use volatile solvents such as alcohol, benzene or thinners as they may damage the surface finishes
- ◆ Save the package to ensure availability of shipping containers for future transportation

EU Conformity Statement



2012/19/EU (WEEE directive): Products marked with this symbol cannot be disposed of as unsorted municipal waste in the European Union. For proper recycling, return this product to your local supplier upon the purchase of equivalent new equipment, or dispose of it at designated collection points. For more information see:www.recyclethis.info.



2006/66/EC (battery directive): This product contains a battery that cannot be disposed of as unsorted municipal waste in the European Union. See the product documentation for specific battery information. The battery is marked with this symbol, which may include lettering to indicate cadmium (Cd), lead (Pb), or mercury(Hg). For proper recycling, return the battery to your supplier or to a designated collection point. For more information see:www.recyclethis.info.

Table of Contents

Chapter I Product Description.....	1
1.1 Product Overview.....	1
1.2 Key Features.....	1
1.3 Hardware Overview.....	2
1.4 How to Connect to Alarm Interface.....	16
1.5 How to Connect the Water-proof Connector.....	16
1.6 System Requirements.....	17
Chapter II Network Connection.....	18
2.1 Setting the Camera over the LAN.....	18
2.1.1 Connect the Camera to the PC Directly.....	18
2.1.2 Connect via a Switch or a Router.....	18
2.2 Dynamic IP Connection.....	18
Chapter III Accessing the Network Camera.....	20
3.1 Assigning An IP Address.....	20
3.1.1 Assigning An IP Address Using Smart Tools.....	20
3.1.2 Assign An IP Address via Browser.....	23
3.2 Accessing from the Web Browser.....	26
3.2.1 Access with Plugin.....	26
3.2.2 Access without Plugin.....	28
3.3 Accessing from Milesight VMS (Video Management Software).....	28
Chapter IV System Operation Guide.....	30
4.1 Live Video.....	30
4.2 Playback.....	32
4.3 Local Settings.....	34
4.4 Basic Settings.....	34
4.4.1 Video.....	34
4.4.2 Image.....	37
4.4.3 Audio.....	46
4.4.4 Network.....	47
4.4.5 Date&Time.....	58
4.5 Advanced Settings.....	59
4.5.1 Alarm.....	59
4.5.2 Storage.....	68
4.5.3 Security.....	71
4.5.4 SIP.....	75
4.5.5 VCA.....	77
4.5.6 Face Detection(Optional).....	89
4.5.7 Heat Map(Optional).....	91
4.5.8 Logs.....	97
4.6 LPR(Optional).....	98
4.6.1 Live Video.....	98
4.6.2 Settings.....	98
4.6.3 Smart Search.....	110

4.7 System.....	111
4.8 Maintenance.....	112
4.8.1 System Maintenance.....	112
4.8.2 Auto Reboot.....	114
Chapter V Services.....	114

Chapter I Product Description

1.1 Product Overview

Milesight provides a consistent range of cost-effective and reliable network cameras to fully meet your requirements. Based on embedded Linux operating system, Milesight network cameras could be easily accessed and managed either locally or remotely with great reliability. With built-in high-performance DSP video processing modules, the cameras pride on low power consumption and high stability. They support state-of-the-art H.265/ H.264/ MJPEG video compression algorithm and industry-leading HD dual-stream technology to achieve the highest level of video image quality under the limited network resources. It is fully functional, supporting for flexible and comprehensive alarm linkage mechanism, day and night auto switch and privacy masking, etc.

In practical applications, Milesight network cameras could either work independently in the LAN, or be networked to form a powerful safety monitoring system. It is widely used in fields such as finance, education, industrial production, civil defense, health care for security's sake.

1.2 Key Features

- ✧ Based on Linux OS with high reliability
- ✧ H.265/ H.264/ MJPEG video compression capability
- ✧ Support Plugin-Free mode
- ✧ Support Smart Stream
- ✧ Support ONVIF Profile G & Q & S & T
- ✧ Support activation and set-up of the security questions for cameras(for V4x.7.0.69 or above)
- ✧ Support Primary Stream/ Secondary Stream/ Tertiary Stream
- ✧ Support PoE for power supply
- ✧ Support Video Content Analysis
- ✧ ICR filter with auto switch, true day/night
- ✧ Built-in WEB server, support IE/ Firefox/ Chrome/ Safari browser
- ✧ UPnP protocol for the easy management of IPC
- ✧ Support Milesight DDNS
- ✧ Motion Detection, Privacy Masking, Network Fault Detection and ROI
- ✧ Support Heat Map function
- ✧ FTP upload, SMTP upload, SD card record and SIP phone
- ✧ G.711/AAC audio compression capability
- ✧ Alarm I/O(built-in for pro bullet and box cameras, optional for dome cameras)
- ✧ Built-in Microphone(built-in for (IR) Mini Dome, Vandal-proof Mini Dome, Weather-proof Mini Dome and AF Motorized Mini Dome, optional for Pro Dome)
- ✧ Real-time video electronic amplification
- ✧ Three-privilege levels of users for flexible management
- ✧ Micro SD/SDHC/SDXC card local storage support, expand the edge storage
- ✧ Local PAL/NTSC signal output(for Pro Bullet)

1.3 Hardware Overview

1. IR Mini Dome Network Camera

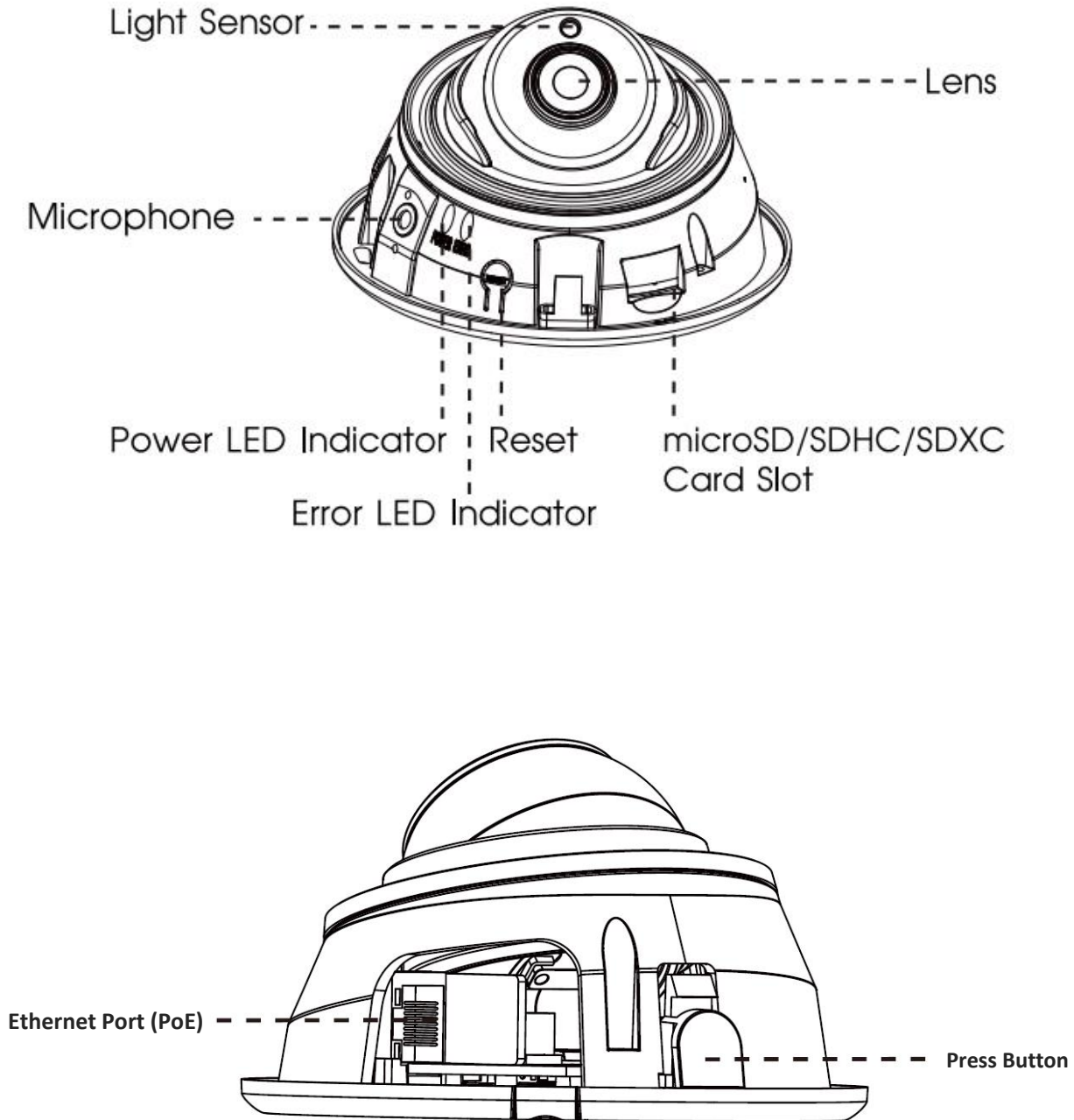

Figure 1-3-2 IR Mini Dome Network Camera

Note:

- 1) Error LED Indicator: Error LED Indicator is on when the device starts up or runs error.
- 2) Reset Button: Press "Reset" button for 5 seconds, then the device will be restored to factory default.
- 3) Only PoE is available for power supply.

2. Vandal-proof Mini Dome Network Camera

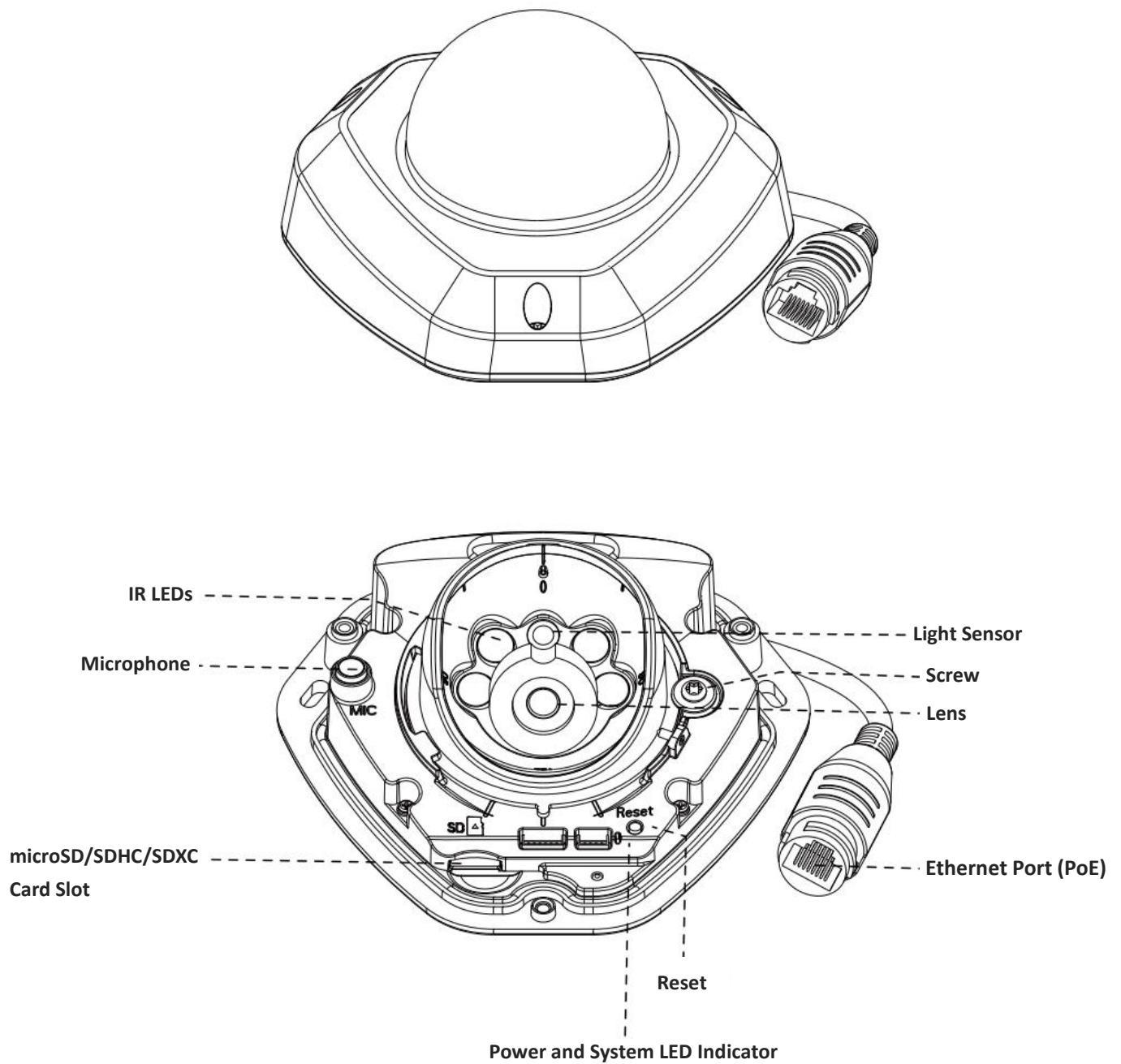

Figure 1-3-3 Vandal-proof Mini Dome Network Camera

Note:

- 1) Error LED Indicator: Error LED Indicator is on when the device starts up or runs error.
- 2) Reset Button: Press "Reset" button for 5 seconds, then the device will be restored to factory default.
- 3) Only PoE is available for power supply.

3. Weather-proof Mini Dome Network Camera

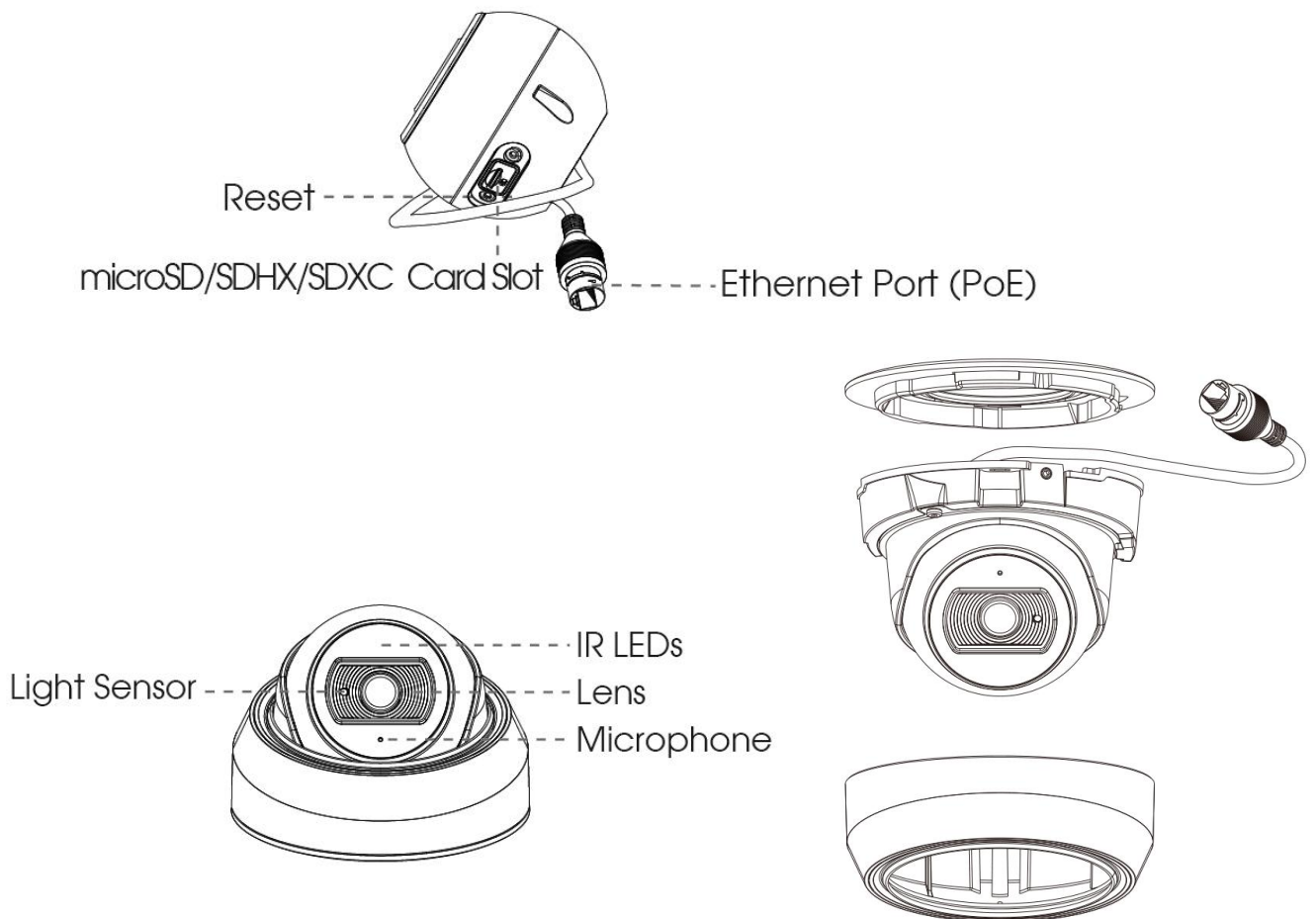

Figure 1-3-4 Weather-proof Mini Dome Network Camera

Note:

- 1) **Reset Button:** Press “Reset” button for 5 seconds, then the device will be restored to factory default.
- 2) Only PoE is available for power supply.

4. AF Motorized Mini Dome Network Camera

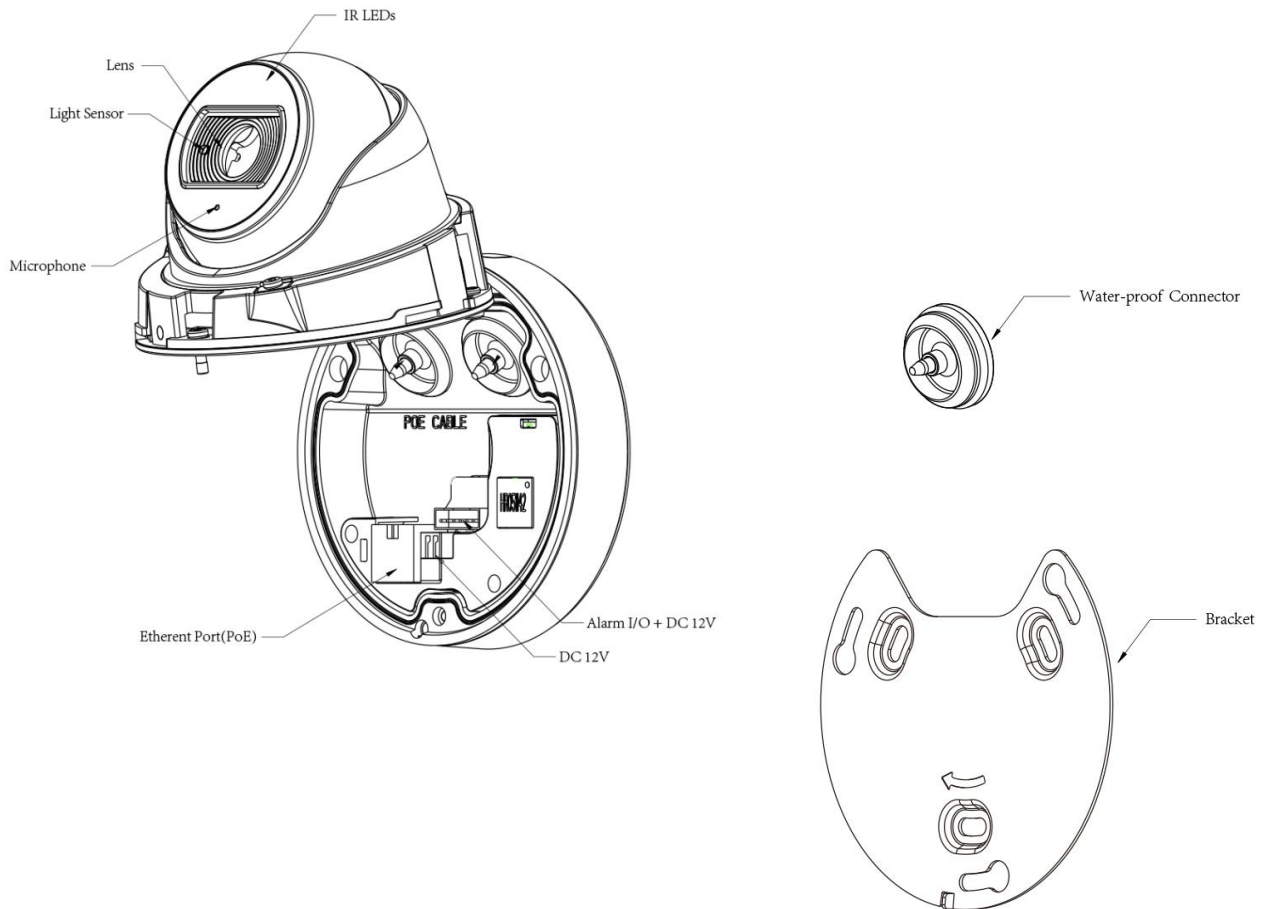

Figure 1-3-5 AF Motorized Mini Dome Network Camera

Note:

- 1) Reset Button: Press “Reset” button for 5 seconds, then the device will be restored to factory default.
- 2) DC 12V and PoE are available for power supply.

5. Mini Bullet Network Camera

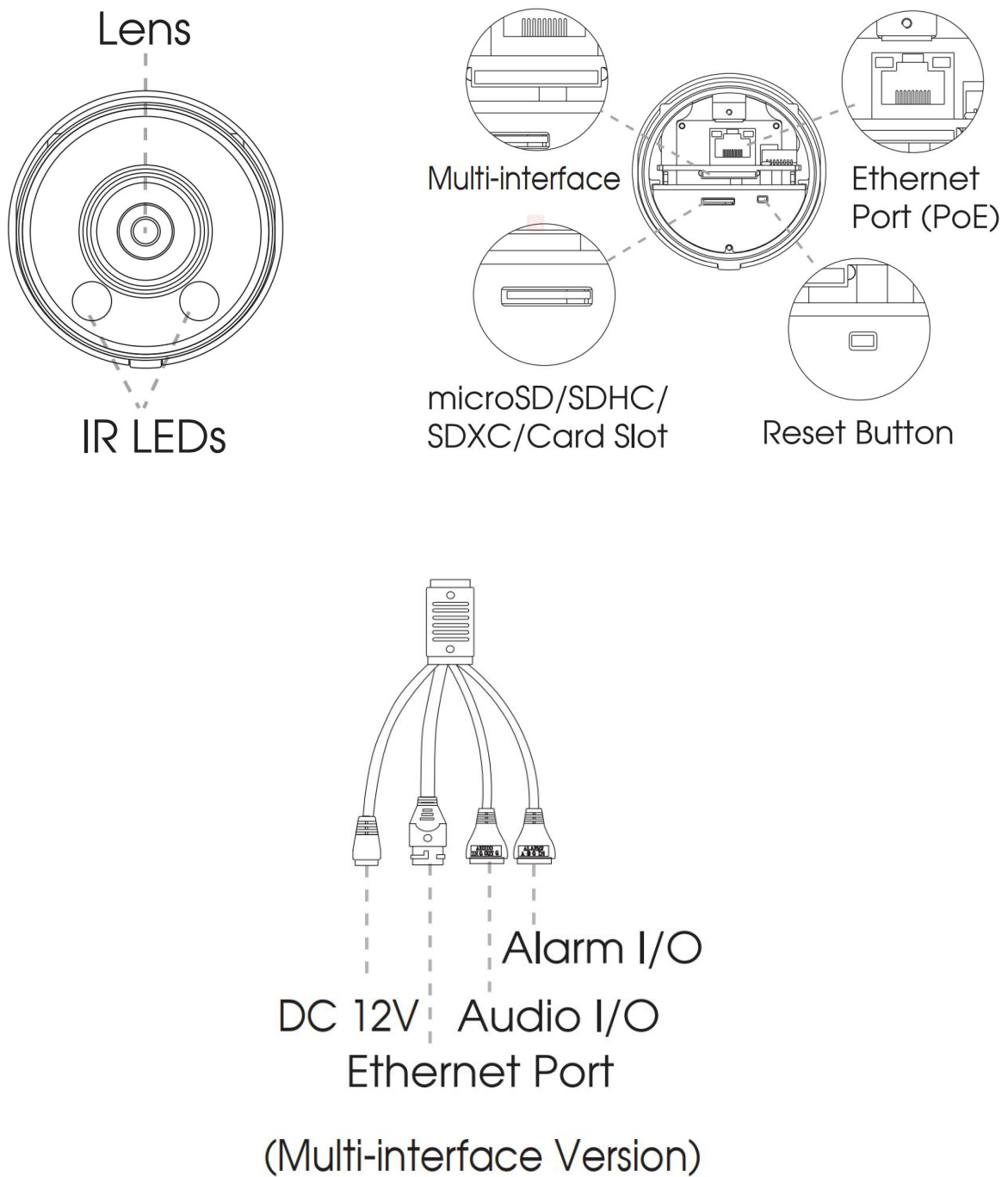

Figure 1-3-6 Mini Bullet Network Camera

Note:

- 1) DC 12V(Only for Multi-interface Version) and PoE are available for power supply.
- 2) Reset Button: Press "Reset" button for 5 seconds, then the device will be restored to factory default.

6. Vandal-proof Mini Bullet Network Camera

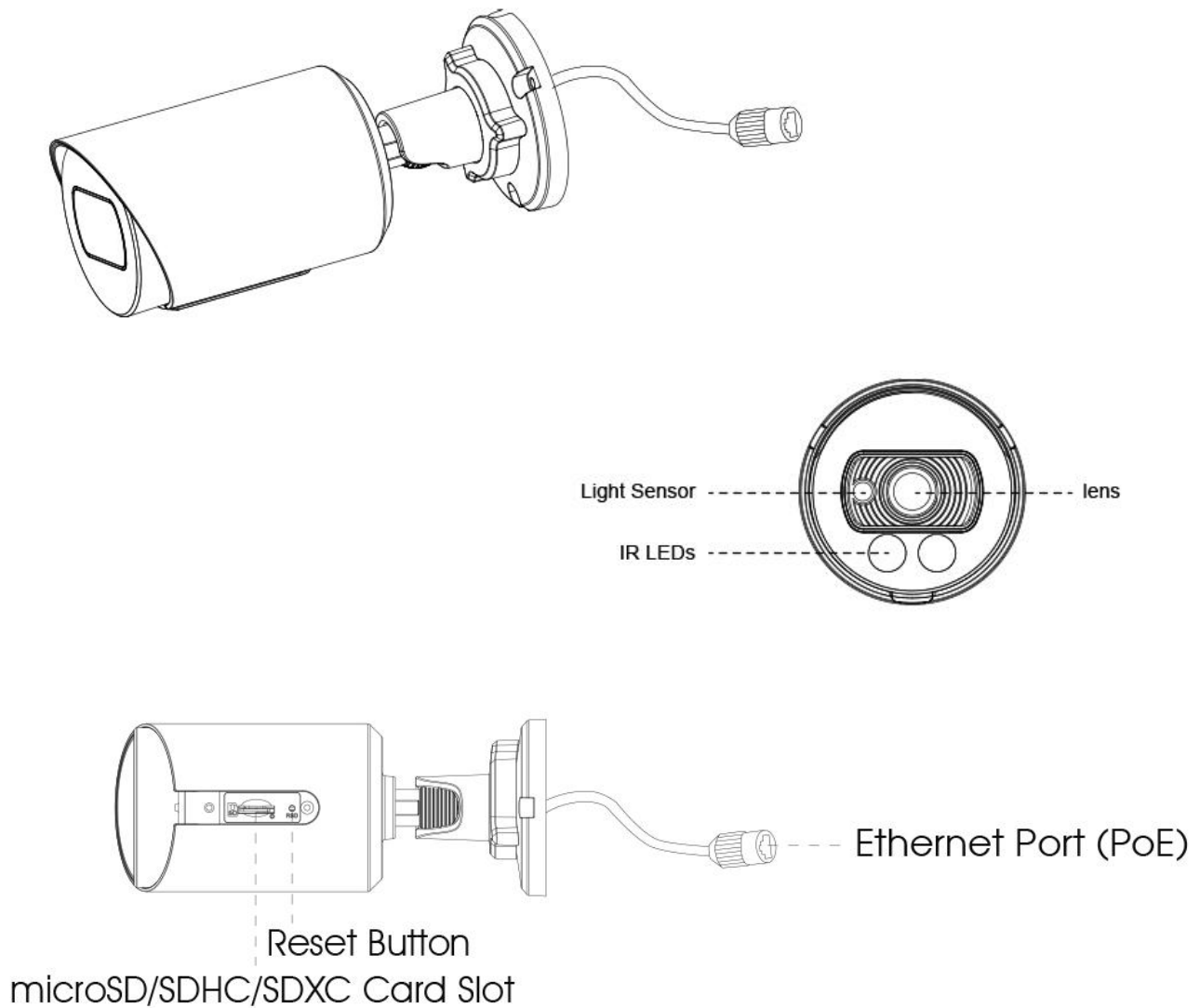

Figure 1-3-7 Vandal-proof Mini Bullet Network Camera

Note:

- 1) Only PoE is available for power supply.
- 2) Reset Button: Press "Reset" button for 5 seconds, then the device will be restored to factory default.

7. (Vandal-proof) Motorized Mini Bullet Network Camera

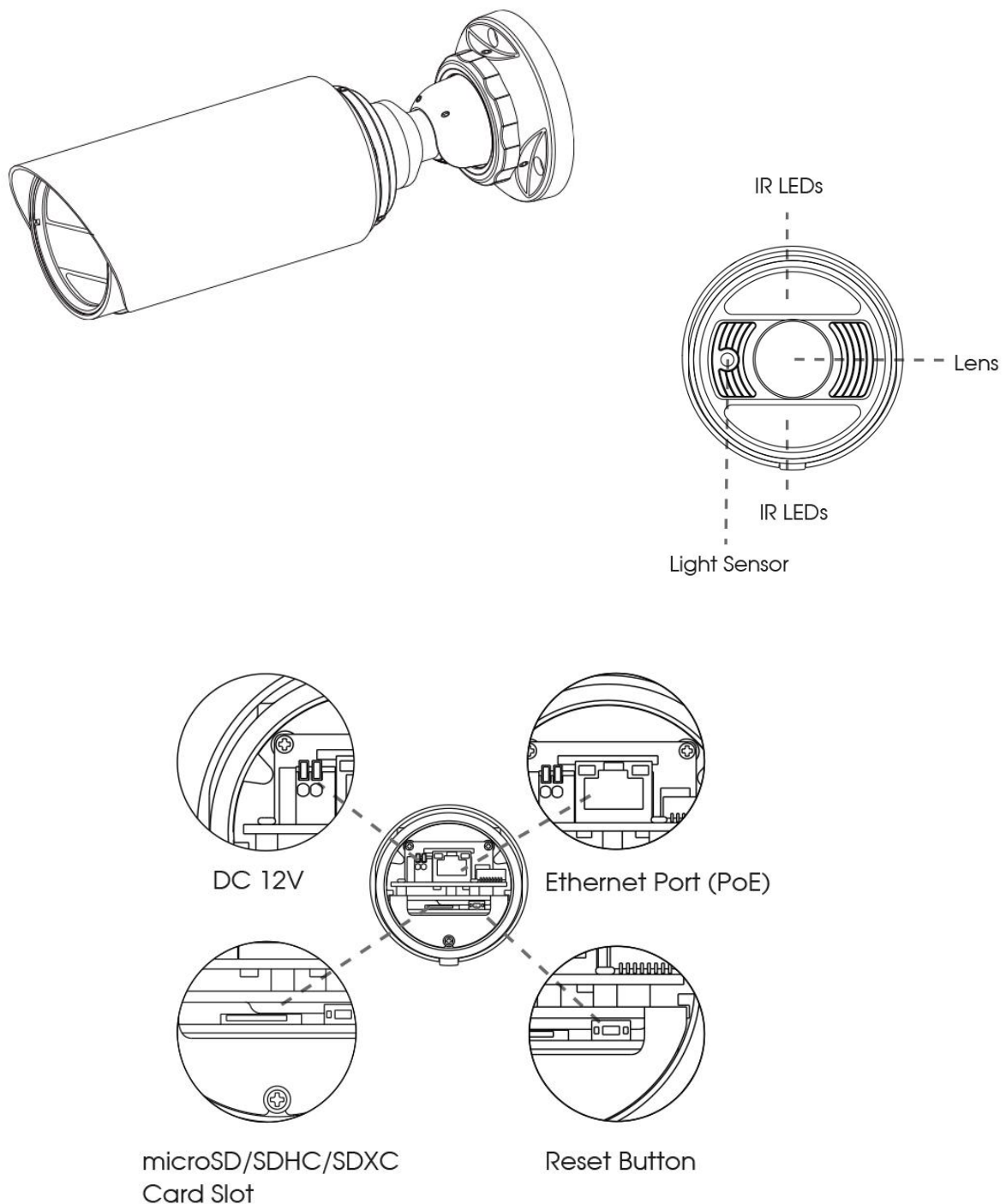
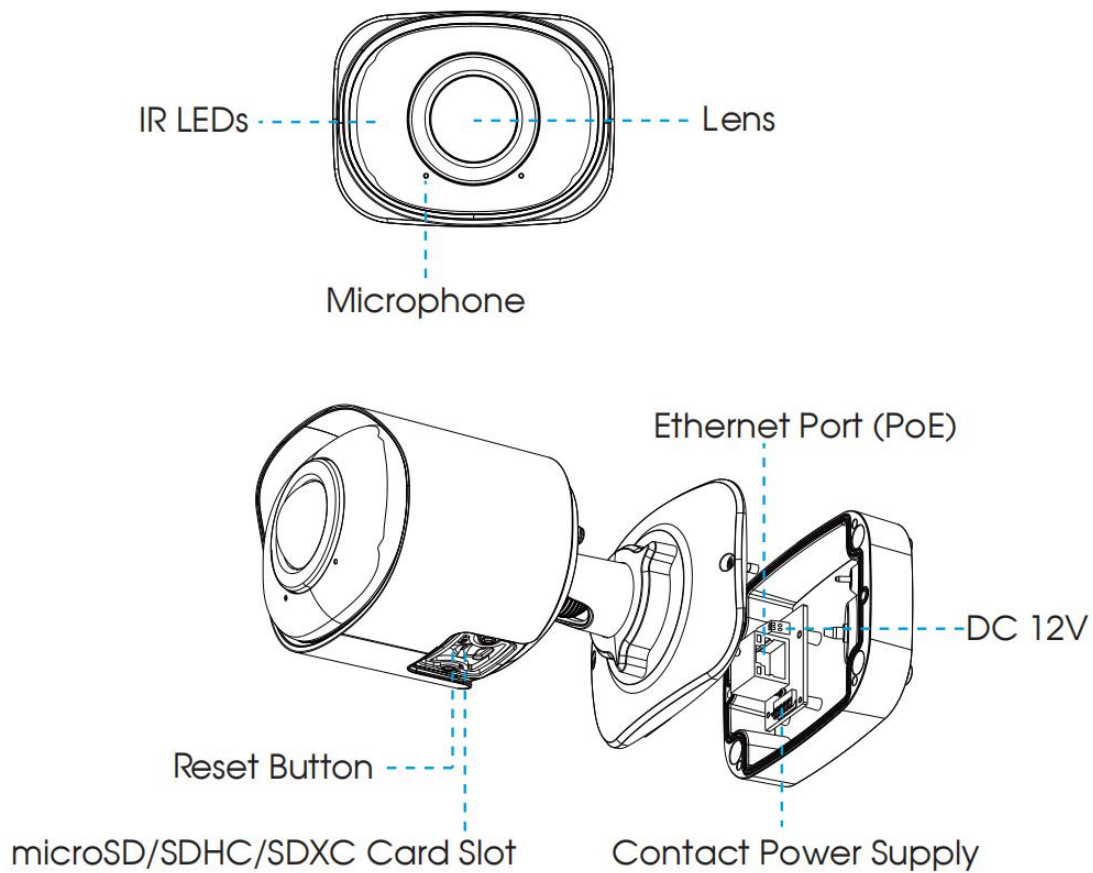

Figure 1-3-8 (Vandal-proof) Motorized Mini Bullet Network Camera

Note:

- 3) DC 12V and PoE are available for power supply.
- 4) Reset Button: Press "Reset" button for 5 seconds, then the device will be restored to factory default.

8. 180° Panoramic Mini Bullet Network Camera



Note:

- 1) PoE is available for power supply.
- 2) Reset Button: Press "Reset" button for 5 seconds, then the device will be restored to factory default.

9. 180° Panoramic Mini Dome Network Camera

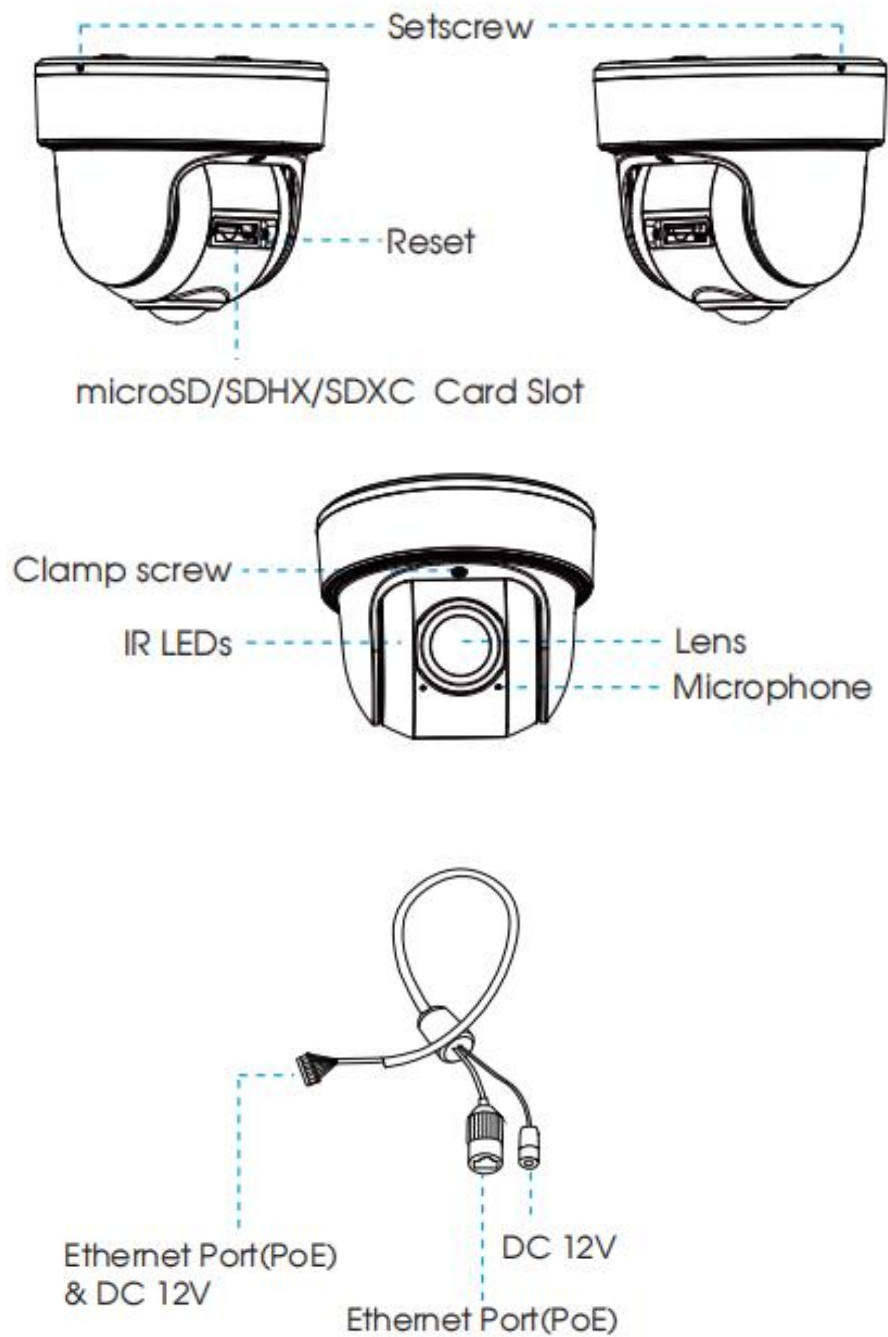

Note:

- 3) PoE is available for power supply.
- 4) Reset Button: Press "Reset" button for 5 seconds, then the device will be restored to factory default.

10. (AI) (12X AF) Motorized Pro Bullet Network Camera

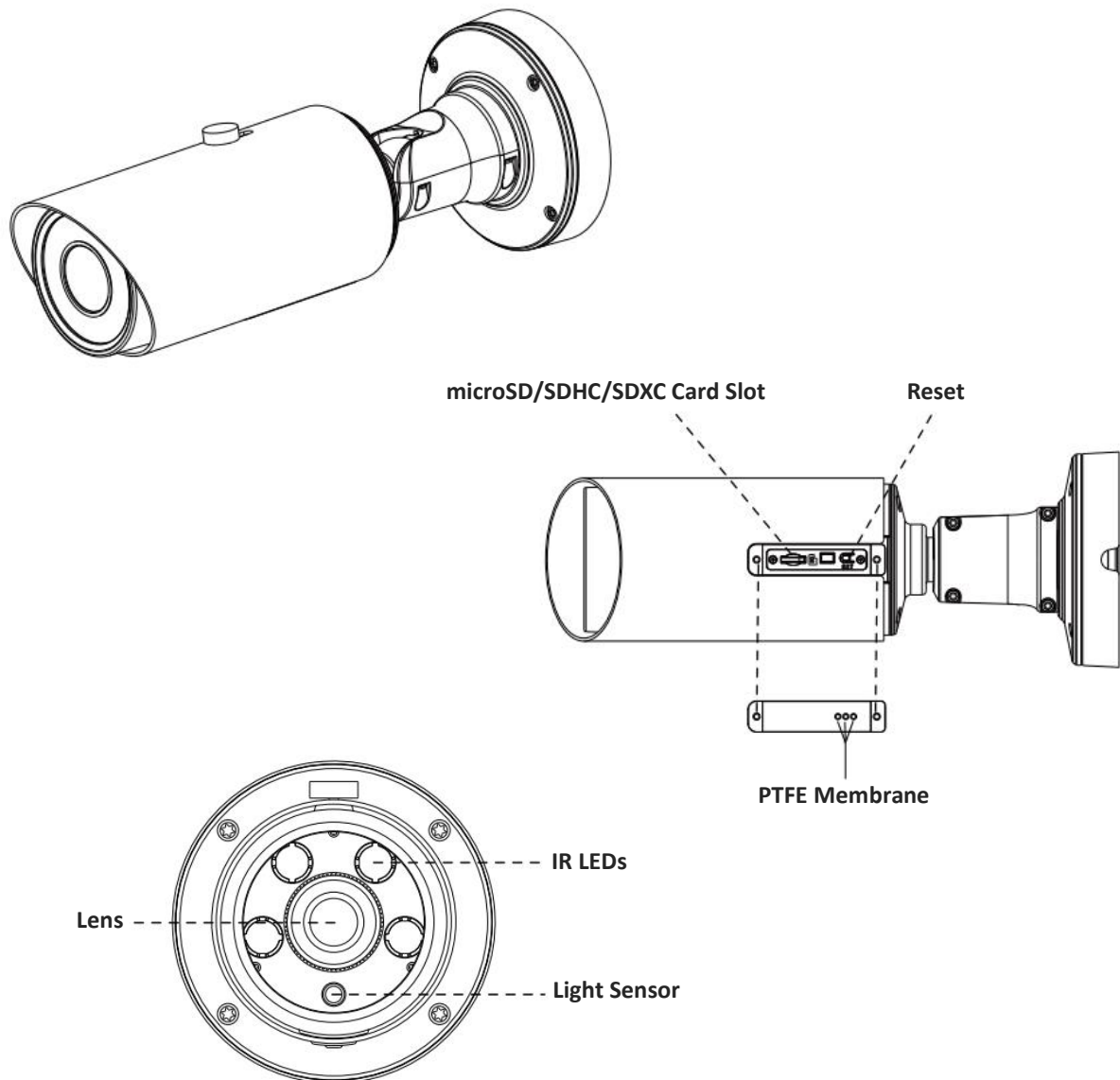

Figure 1-3-9 (12x AF) Motorized Pro Bullet Network Camera

Note:

- 5) DC 12V and PoE are available for power supply.
- 6) Reset Button: Press “Reset” button for 5 seconds, then the device will be restored to factory default.
- 7) There are two versions for Pro Bullet: the interface’s pictures are as below.

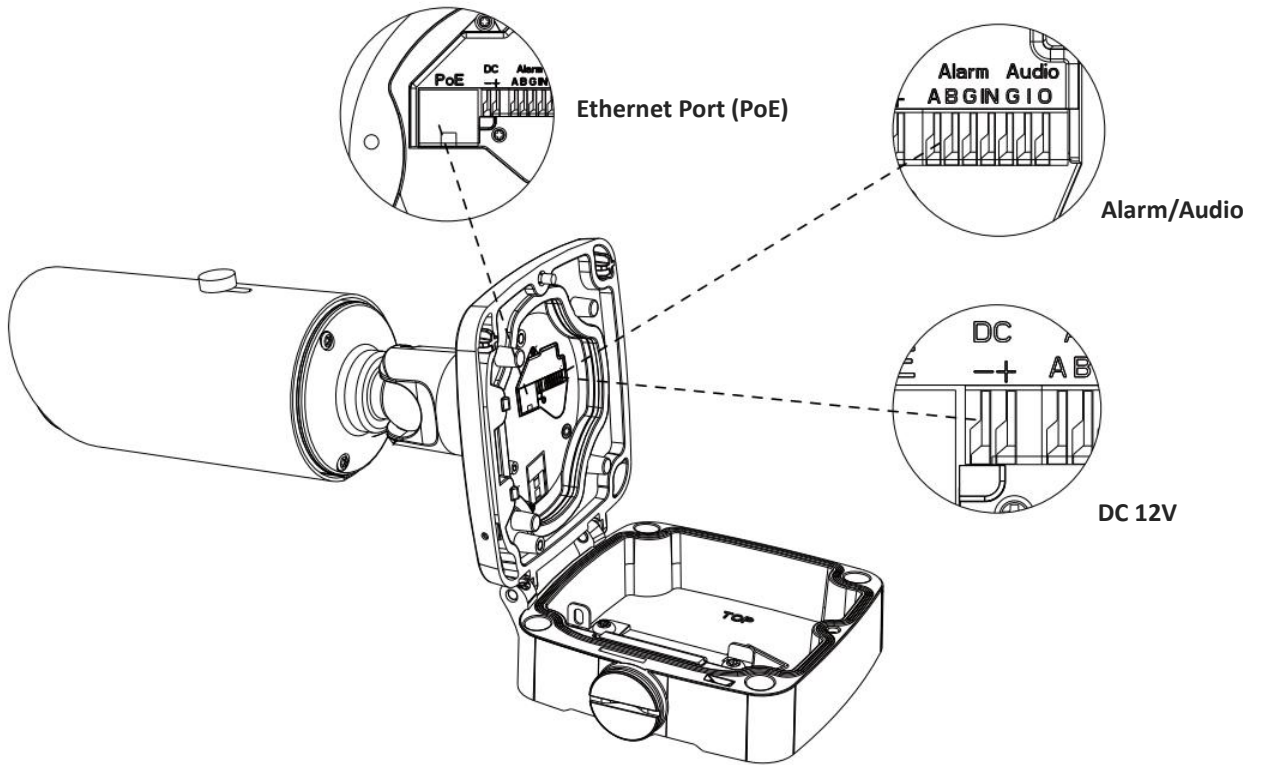

Figure 1-3-10 Motorized Pro Bullet Network Camera (Version A)

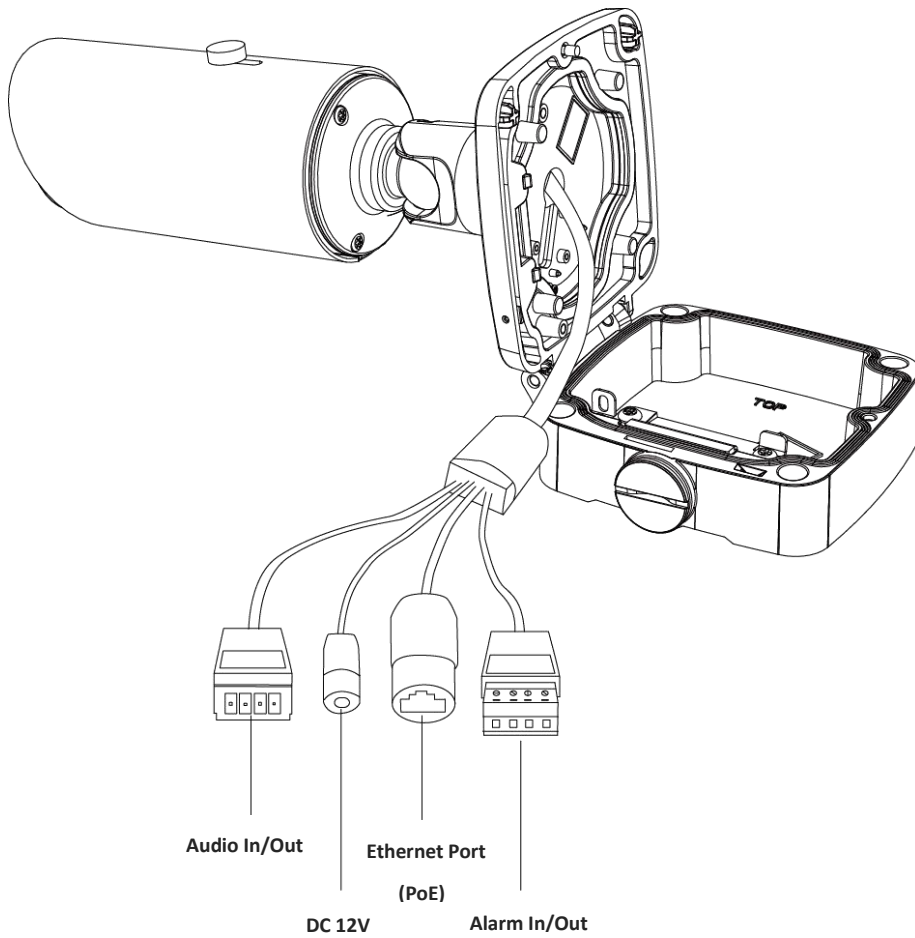

Figure 1-3-11 Motorized Pro Bullet Network Camera (Version B)

11. (AI) Motorized Pro Dome Network Camera

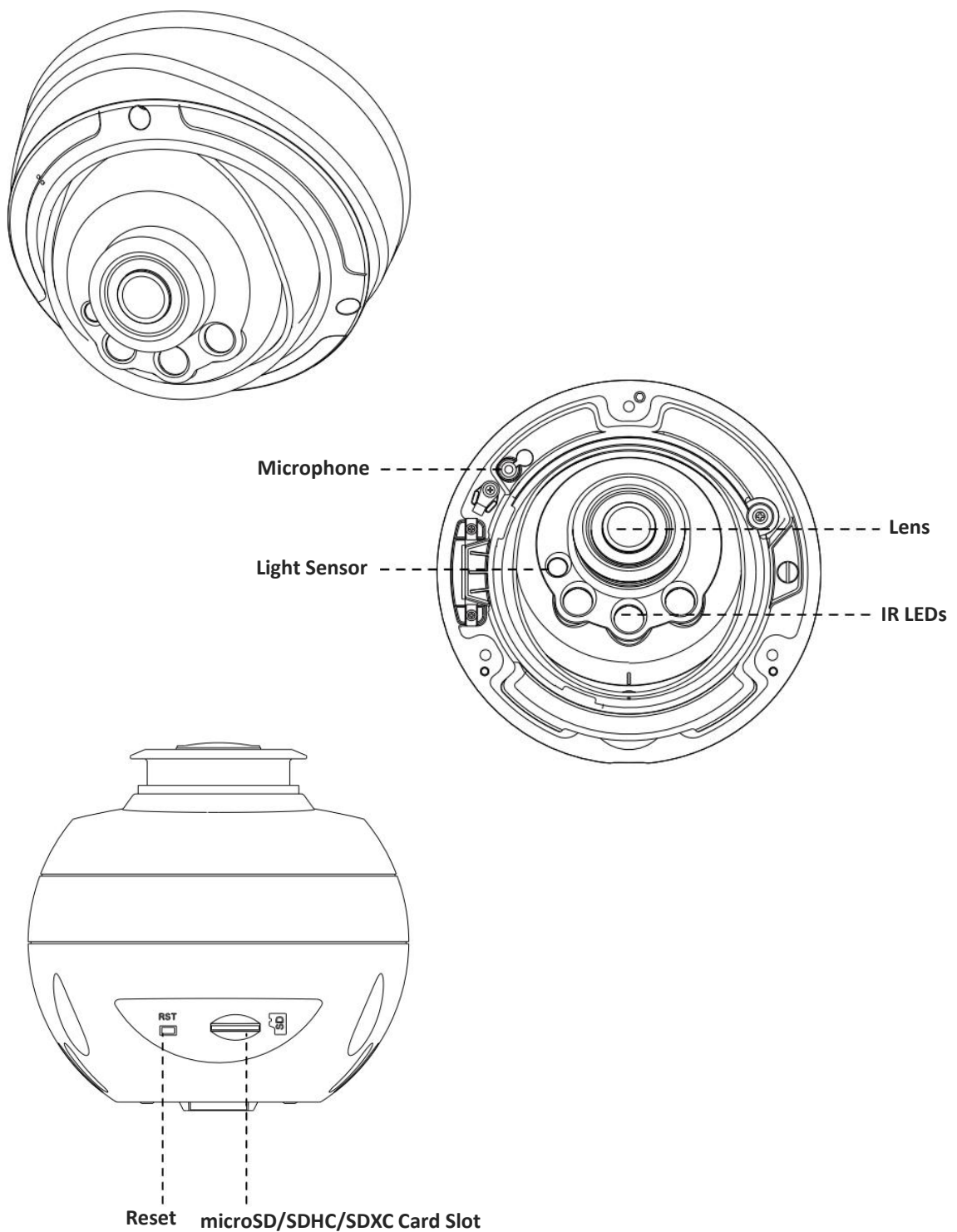

Figure 1-3-12 Motorized Pro Dome Network Camera

Note:

- 1) Reset Button: Press "Reset" button for 5 seconds, then the device will be restored to factory default.

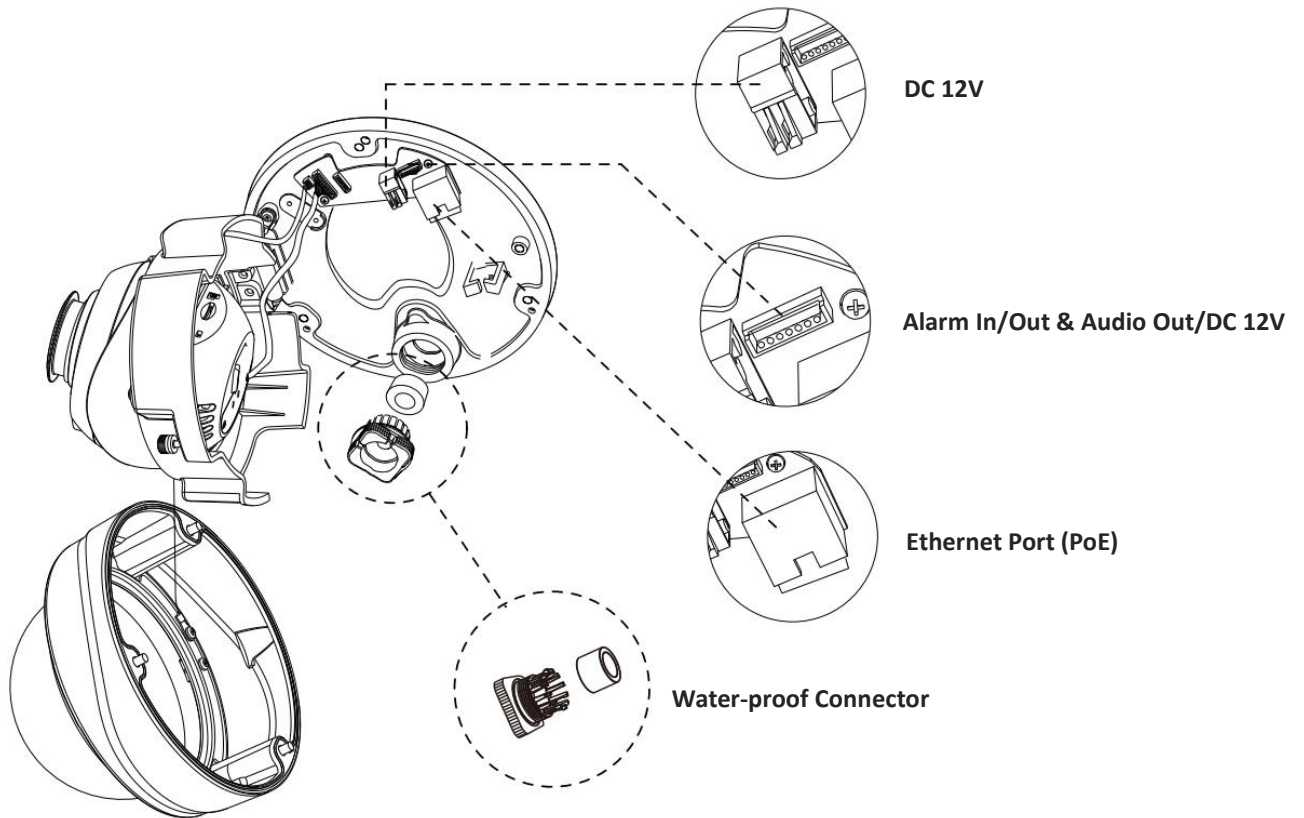

Figure 1-3-13 Motorized Pro Dome Network Camera multiple interface

Here is one equipped cable for multiple interface usage:

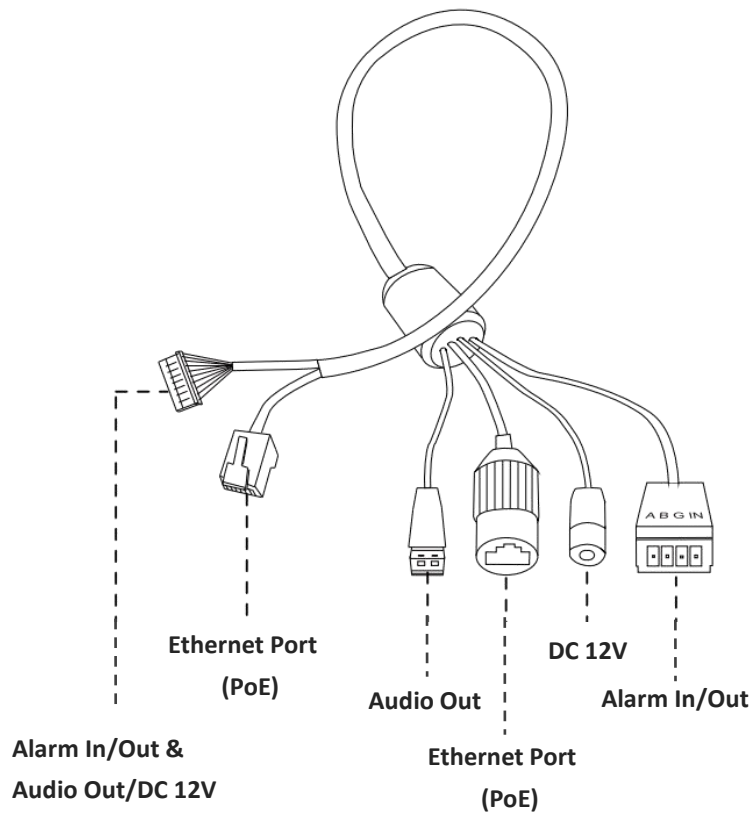

Figure 1-3-14 Motorized Pro Dome Network Camera multiple interface cable

12. (LPR) (ABF) Pro Box Network Camera

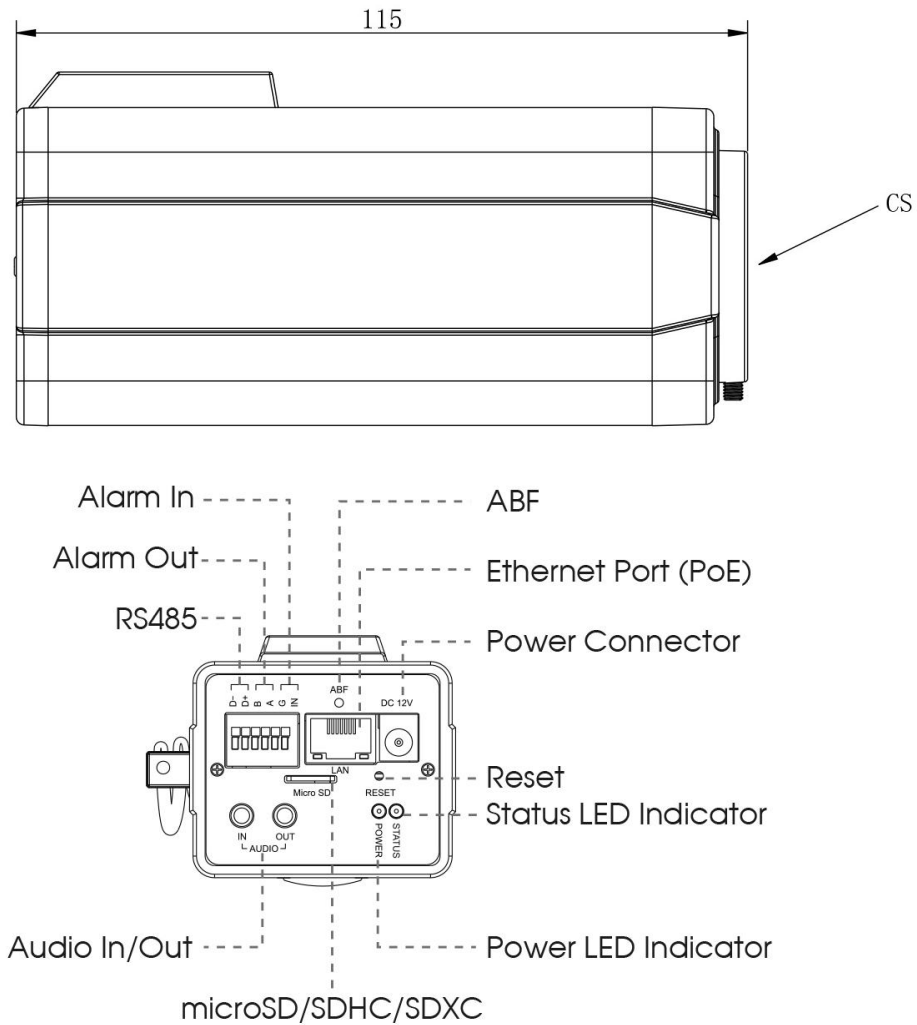

Figure 1-3-15 (ABF) Pro Box Network Camera

Note:

- 1) Reset Button: Press “Reset” button for 5 seconds, then the device will be restored to factory default.
- 2) DC 12V and PoE are available for power supply.

1.4 How to Connect to Alarm Interface

External interface of camera is as the following, you can refer to the picture to install the external alarm device:

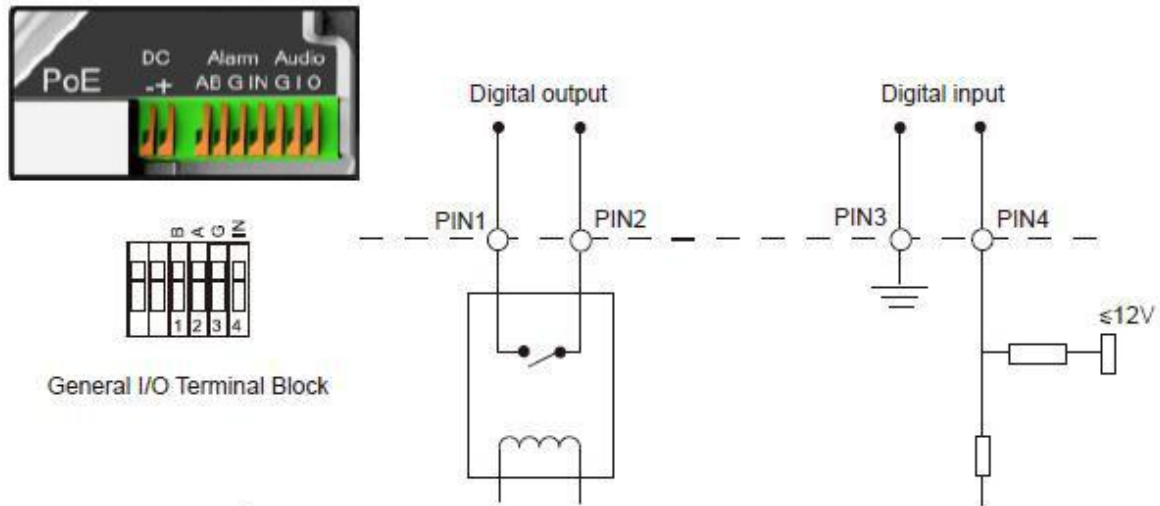

PIN1: Alarm Output NC/NO 24V DC 1A

PIN2: Alarm Output NC/NO 24V DC 1A

PIN3: Alarm Input NC/NO $\leq 12V$

PIN4: Alarm Input NC/NO $\leq 12V$

1.5 How to Connect the Water-proof Connector

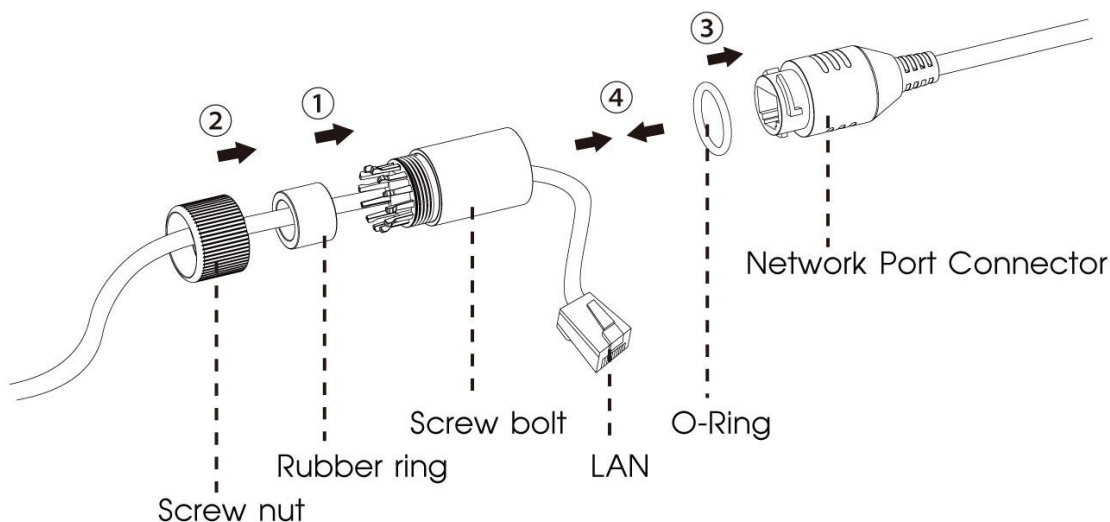

Step1: Get the network cable through the screw nut, rubber ring and the screw bolt.

Step2: Insert the rubber ring into the screw bolt.

Step3: Connect the screw nut to the screw bolt.

Step4: Place the O-Ring on the network port connector.

Step5: Connect the RJ45 to the network port connector, and tighten the screw bolt and the connector.

1.6 System Requirements

Operating System: Windows XP/Vista/7/8/10/Server 2000/Server 2008

CPU: 1.66GHz or higher

RAM: 1G or higher

Graphic memory: 128MB or more

Internet protocol: TCP/IP (IPv4/IPv6)

Web Browsers: Internet Explorer 8.0 and above version, Mozilla Firefox, Google Chrome and Safari.

Chapter II Network Connection

2.1 Setting the Camera over the LAN

Connecting the camera to a switch or a router is the most common connection method. The camera must be assigned an IP address that is compatible with its LAN.

2.1.1 Connect the Camera to the PC Directly

In this method, only the computer connected to the camera will be able to view the camera. The camera must be assigned a compatible IP address to the computer. Details are shown as the following figure.

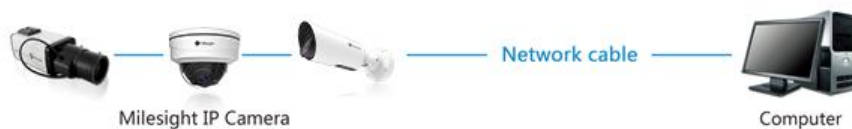

Figure 2-1-1 Connect the camera to the PC directly

2.1.2 Connect via a Switch or a Router

Refer to the following figure to set network camera over the LAN via the switch or router.

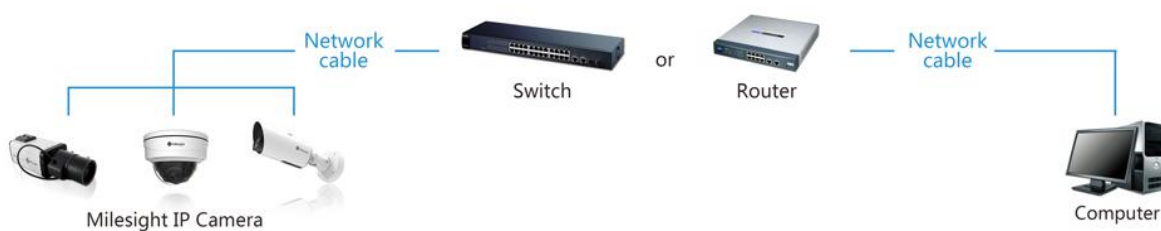

Figure 2-1-2 Connect via a switch or a Router

2.2 Dynamic IP Connection

◆ Connecting the network camera via a router

Step1: Connect the network camera to a router;

Step2: On the camera, assign a LAN IP address, the Subnet mask and the Gateway;

Step3: On the router, set port forwarding. E.g. 80, 8000 and 554 ports. The steps for port forwarding vary depending on different routers. Please look up the router's user manual for assistance with port forwarding;

Step4: Apply a domain name from a domain name provider;

Step5: Configure the DDNS settings in the setting interface of the router;

Step6: Visit the camera via the domain name.



Figure 2-2 Connect the network camera via a router using dynamic IP

Chapter III Accessing the Network Camera

The camera must be assigned an IP address to be accessible.

3.1 Assigning An IP Address

The Network Camera must be assigned an IP address to be accessible. The default IP address of Milesight Network Camera is 192.168.5.190.

You can either change the IP address of the camera via Smart Tools or browser. Please connect the camera in the same LAN of your computer.

3.1.1 Assigning An IP Address Using Smart Tools

Smart Tools is a software tool which can automatically detect multiple online Milesight network cameras in the LAN, set IP addresses, and manage firmware upgrades. It's recommended to use when assigning IP addresses for multiple cameras.

Step1: Install Smart Tools (The software could be downloaded from our website);

Step2: Start Smart Tools, click the IPC Tools page, then enter the device information, such as IP address, MAC address, Status, Port number, Netmask, and Gateway, then all related Milesight network cameras in the same network that will be displayed. Details are shown as shown below;

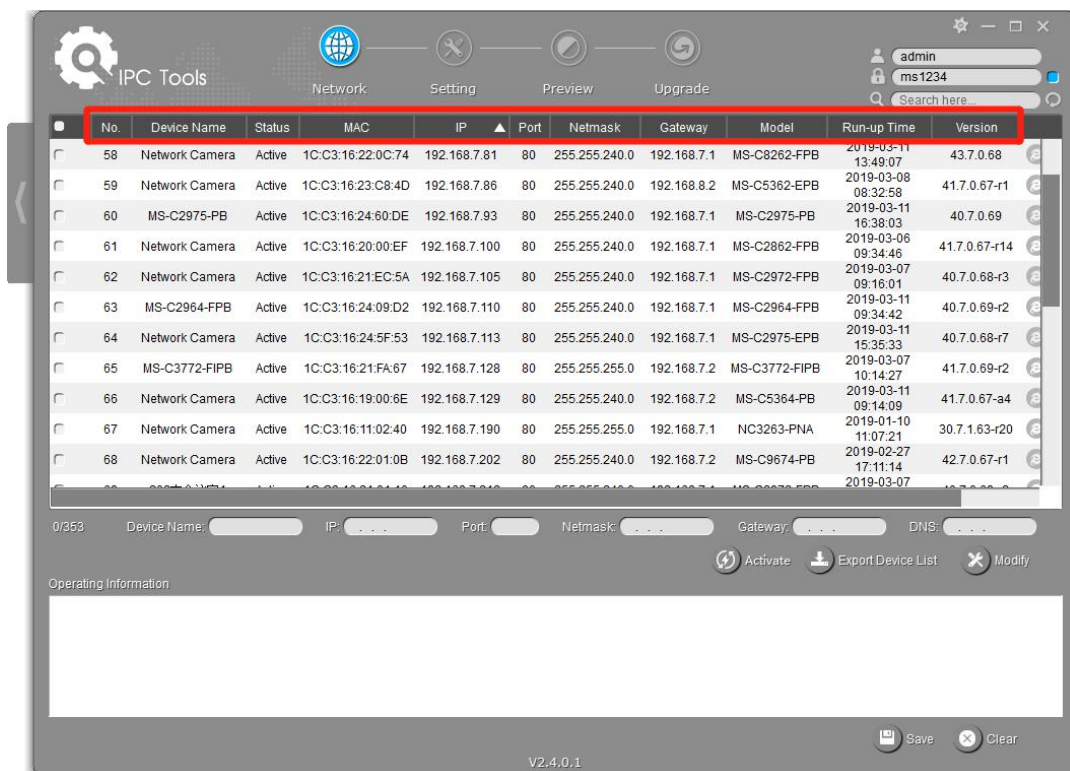

Step3: Select a camera or multiple cameras according to the MAC addresses;

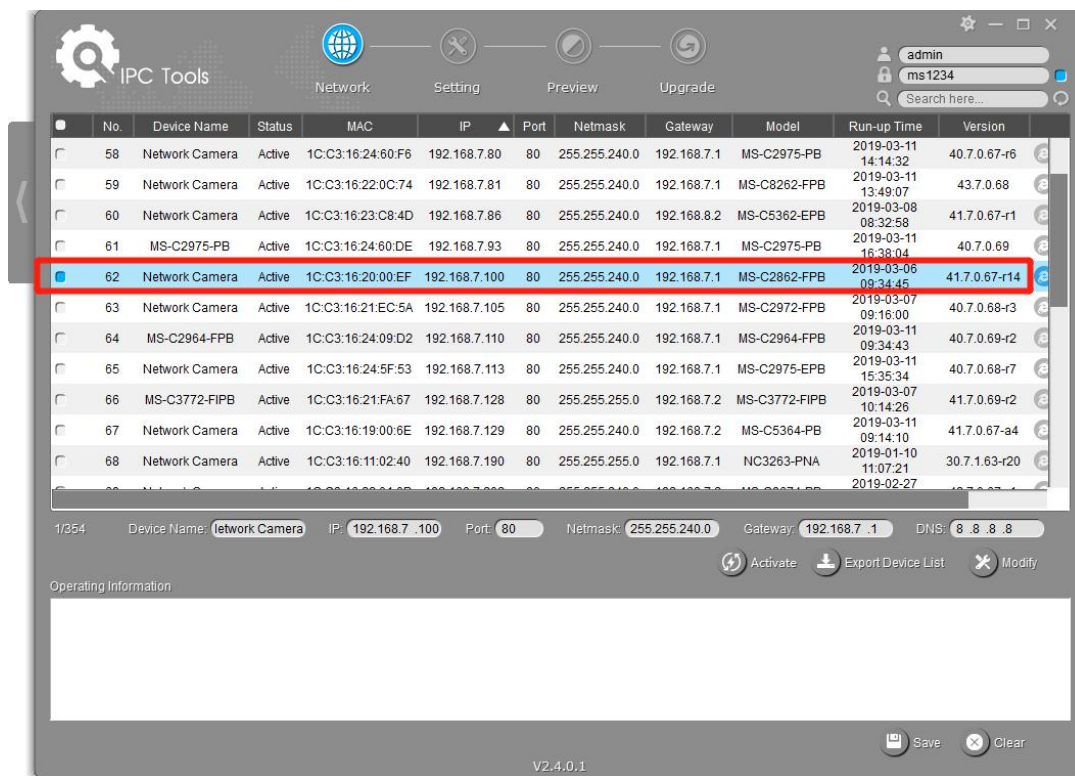

Select single camera

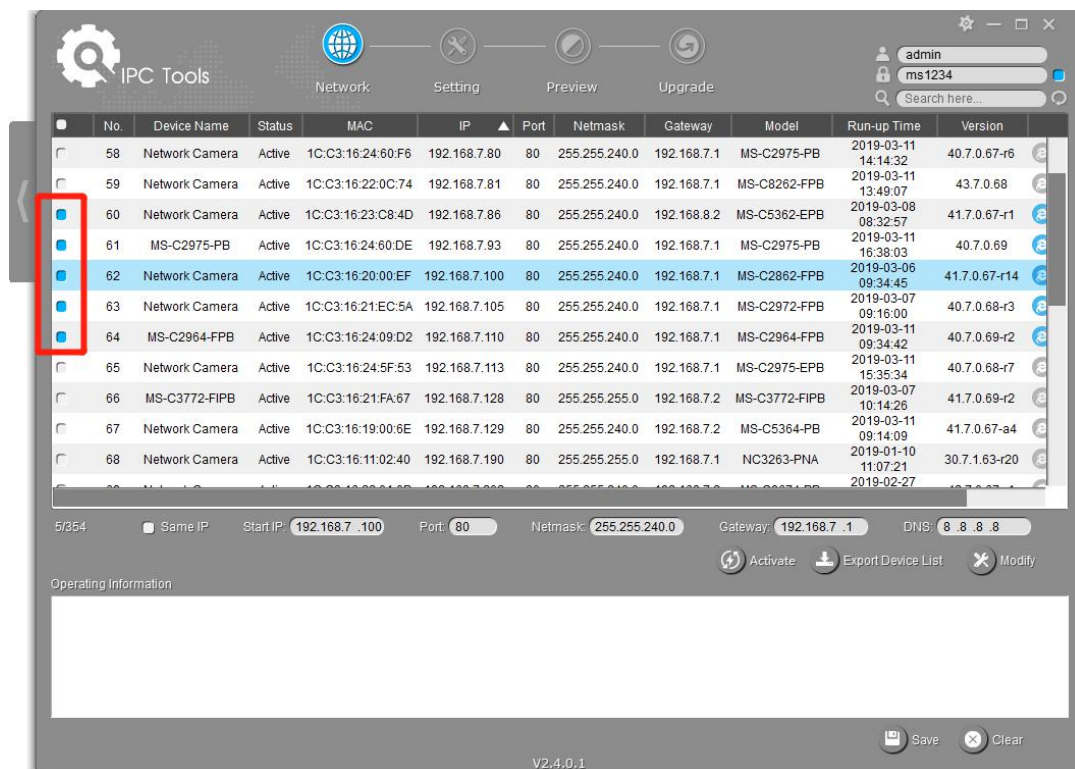

Select multiple cameras

Step4: If the selected camera shows "Active" in the status bar, you can directly type the User Name and Password (Camera with version lower than 4x.7.0.69 is using admin/ms1234 by default), change the IP address or other network values, and then click "Modify" button;

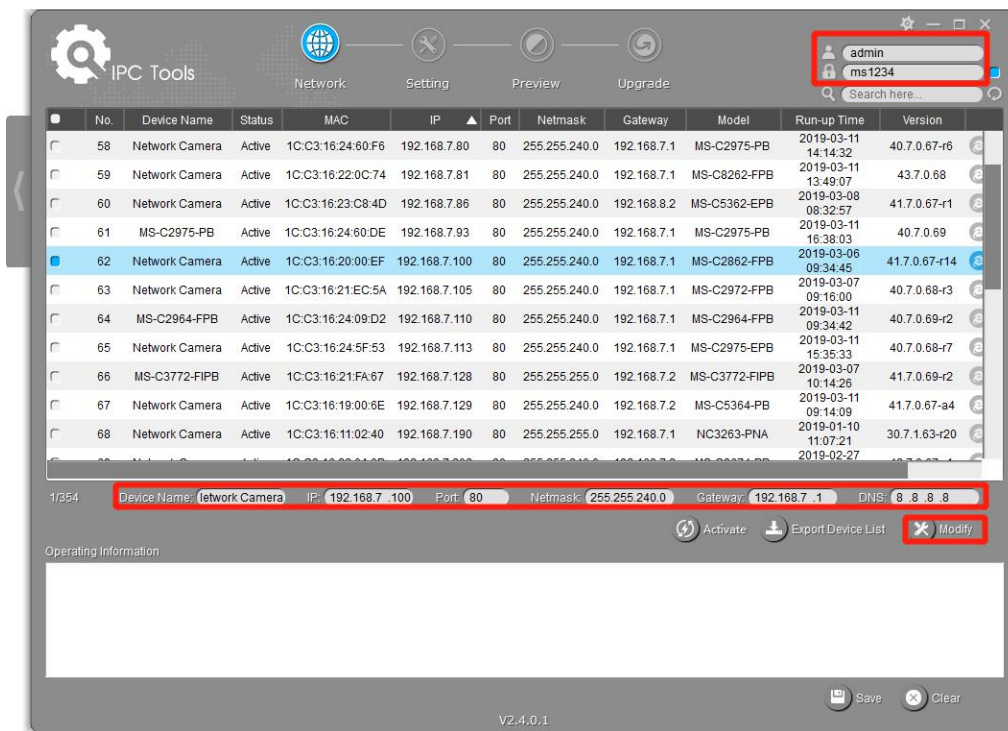

If the selected camera shows "Inactive" in the status bar(Camera with version V4x.7.0.69 or above), click to set the password when using it for the first time. You can also set the security questions when activating the camera in case that you forget the password(You can reset the password by answering three security questions correctly). Click 'Save' and it will show that the activation was successful.

Note:

- (1) Password must be 8 to 32 characters long, contain at least one number and one letter.
- (2) You need to upgrade Smart Tools version to V2.4.0.1 or above to activate the camera.

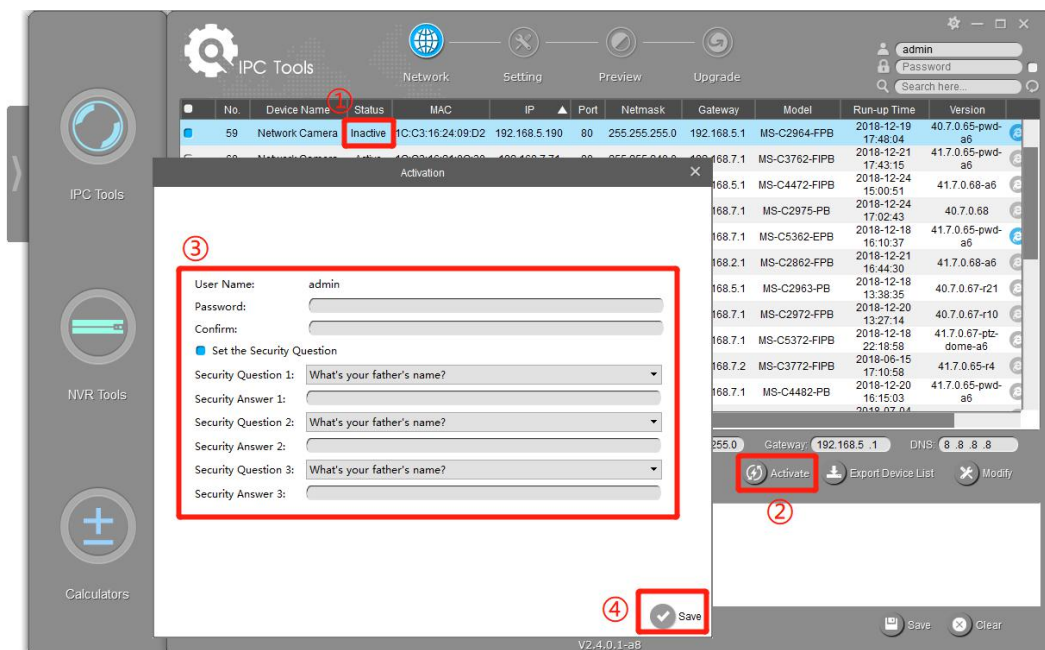

After activation, you can change the IP address or other network values, and then click "Modify" button.

Step5: Change the IP address successfully;

The screenshot displays the Milesight IPC Tools software interface. At the top, there are navigation tabs for Network, Setting, Preview, and Upgrade. A user profile for 'admin' with ID '12345678' is visible in the top right. The main area shows a table of network cameras with columns for No., Device Name, Status, MAC, IP, Port, Netmask, Gateway, Model, Run-up Time, and Version. Row 61 is selected, showing a Network Camera with IP 192.168.7.114. Below the table, a configuration panel for the selected camera is shown, with fields for Device Name, IP, Port, Netmask, Gateway, and DNS. The IP field is highlighted, and a message in the 'Operating Information' section states: '[1C:C3:16:24:09:D2] Modify IP:192.168.7.113->192.168.7.114 successfully.' The interface also includes buttons for Activate, Export Device List, and Modify, and a footer with 'V2.4.0.1-r6'.

Step6: By double clicking the selected camera or the browser of interested camera, you can access the camera via web browser directly. The Internet Explorer window will pop up.

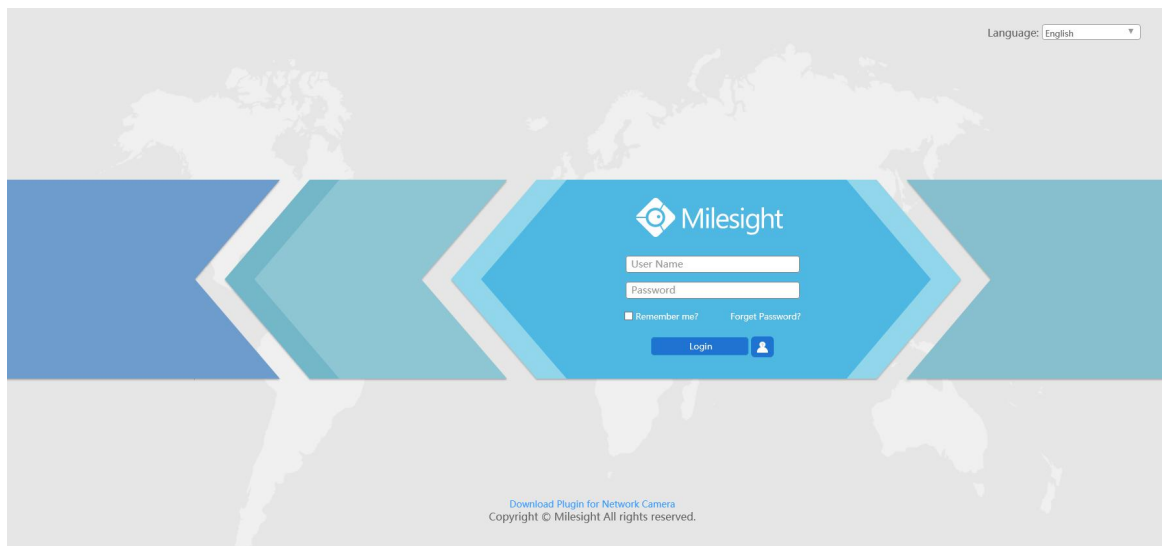

More usage of Smart Tools, please refer to the **Smart Tools User Manual**.

3.1.2 Assign An IP Address via Browser

If the network segment of the computer and that of the camera are different, please follow the

steps to change the IP address:

Step1: Change the IP address of computer to 192.168.5.0 segment, here are two ways as below:

- a. Start → Control Panel → Network and Internet Connection → Network Connection → Local Area Connection, and double click it. (Refer to Figure 3-1-8);

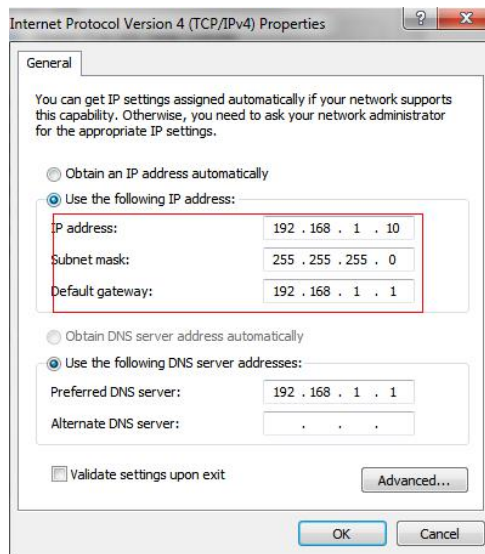
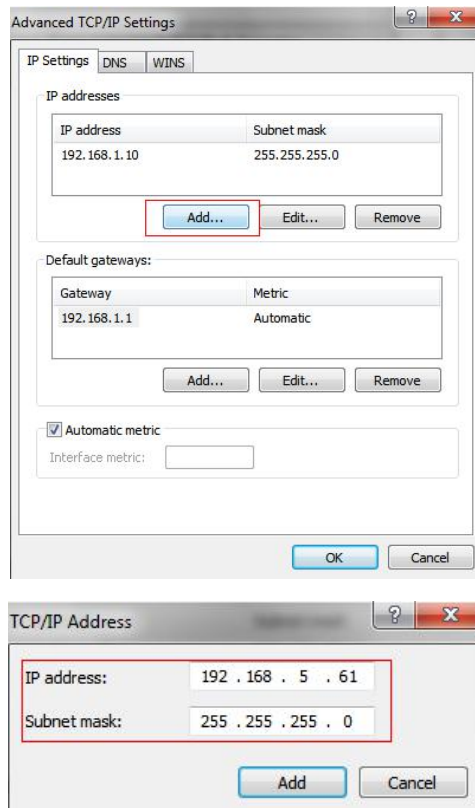

Figure 3-1-8 Setting Network Segment IP Address of Computer

- b. Click “Advanced”, and then click “IP settings” → “IP address” → “Add” (See Figure 3-1-9). In the pop-up window, enter an IP address that in the same segment with Milesight network camera (e.g. 192.168.5.61, but please note that this IP address shall not conflict with the IP address on the existing network);



Step2: Start the browser. In the address bar, enter the default IP address of the camera:
<http://192.168.5.190>;

Step3: If the camera's firmware version is lower than V4x.7.0.69, it will directly display the login page, enter the user name and password when the LOGIN page appears;

Default user name: **admin**

Default password: **ms1234**

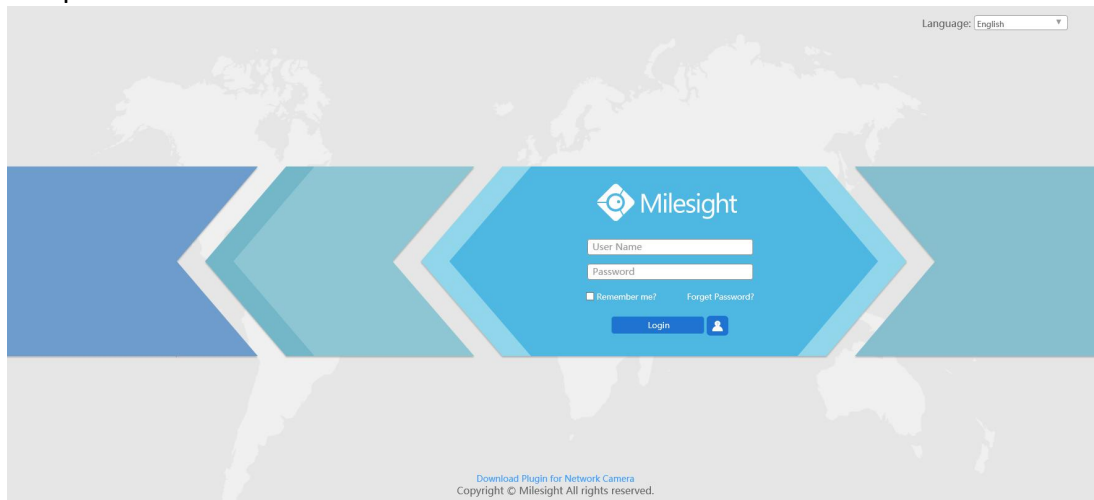

If the camera's firmware version is V4x.7.0.69 or above, you need to set the password first when using it for the first time. And you can also set three security questions for your device after activation. Then, you can log in the device with You can log in to the camera with the username(admin) and a custom password.

Note:

- (1) Password must be 8 to 32 characters long, contain at least one number and one letter.
- (2) You can click the "forget password" in login page to reset the password by answering three security questions when you forget the password, if you set the security questions in advance.

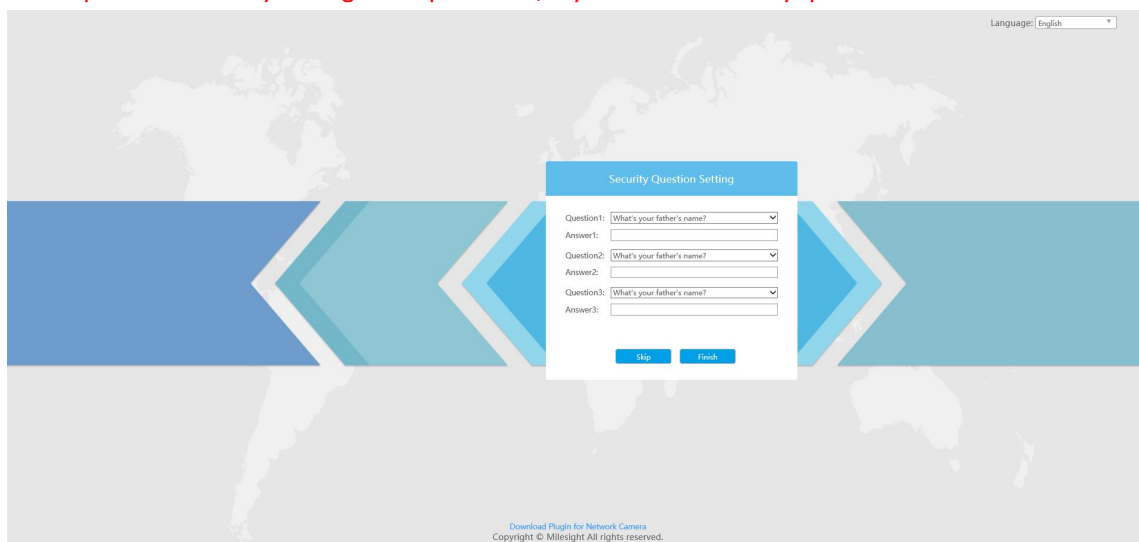

Step4: After login, please select "Configuration" → "Basic Settings" → "Network" → "TCP/IP". The Network Settings page appears (Shown as below Figure);

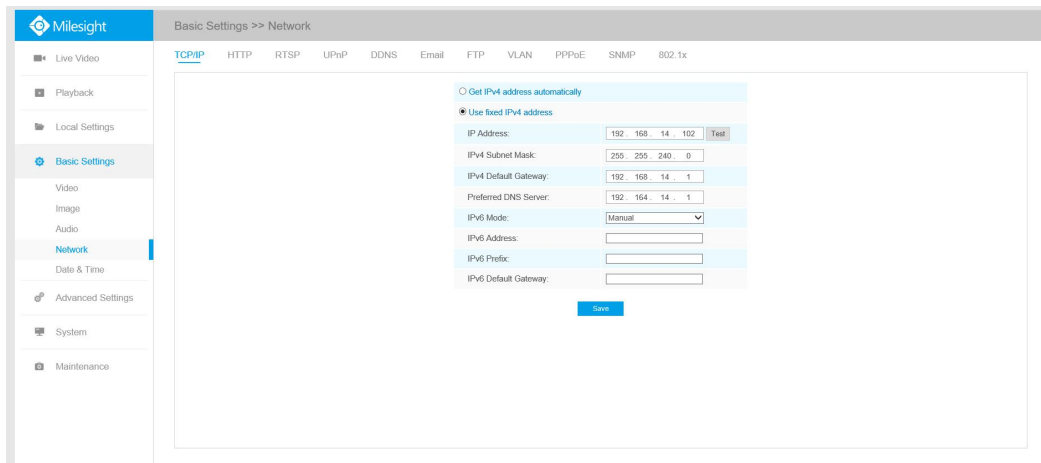

Step5: Change the IP address or other network values. Then click “Save” button;

Step6: The change of default IP address is completed.

3.2 Accessing from the Web Browser

The camera can be used with the most standard operating systems and browsers. The recommended browsers are Internet Explorer, Firefox, Chrome, Microsoft Edge, Safari.

3.2.1 Access with Plugin

Currently you can only access the camera with plugin via Internet Explorer.

Access over IE Browser

Before using the browser to get access to your camera, you need to install the MsActiveX firstly. You can refer the steps as follows:

Step1: Launch the IE browser and enter the IP address of the camera;

Step2: Enter the User Name and Password and click “Login”;

Step3: At the first time to log in the device, the browser will prompt to install Controls, please click “Click here to download and install controls manually” as shown below;

Click here to download and install controls manually

Note: During installing the controls, please keep the browsers close.

Step4: Follow the prompts to install the Controls, when it`s finished, it will pop out a window as shown below. Please click “Finish” and refresh the browser, then you will see the video.

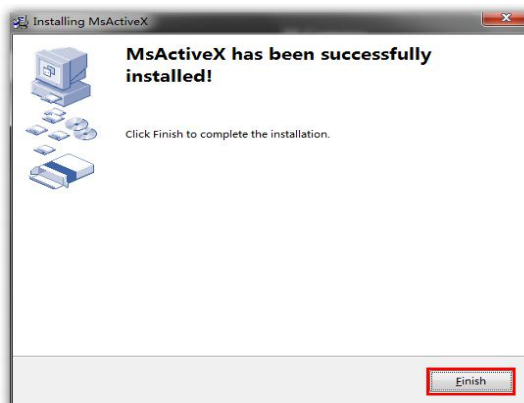

If IE9 or higher version browser is used, it is suggested that the Milesight camera web link should be added as a trusted site. See the instructions as follows:

Step1: Start the IE9 or higher version browser, and select “Tools”→ “Internet Options”;

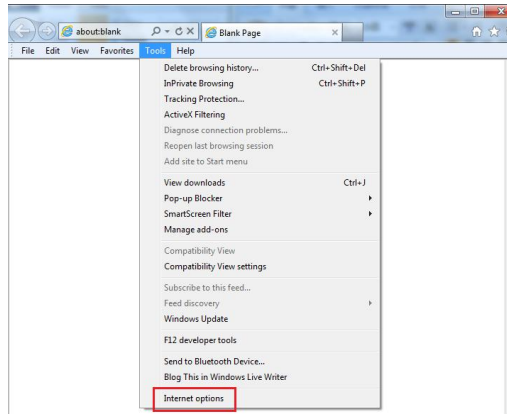

Step2: Select “Security” to “Trusted”;



Step3: Enter the IP address of the camera in the blank and click “Add”;

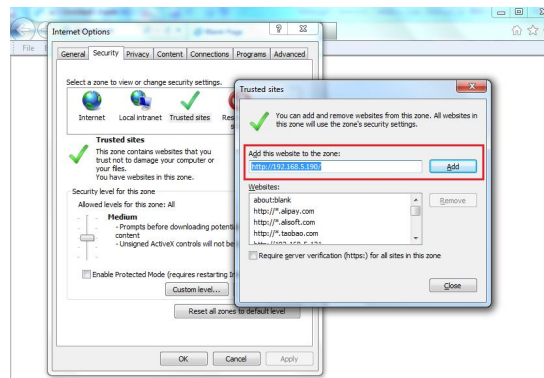

Step4: Enter the IP address. After logging on network camera's web GUI successfully, user is allowed to view live video as follows.

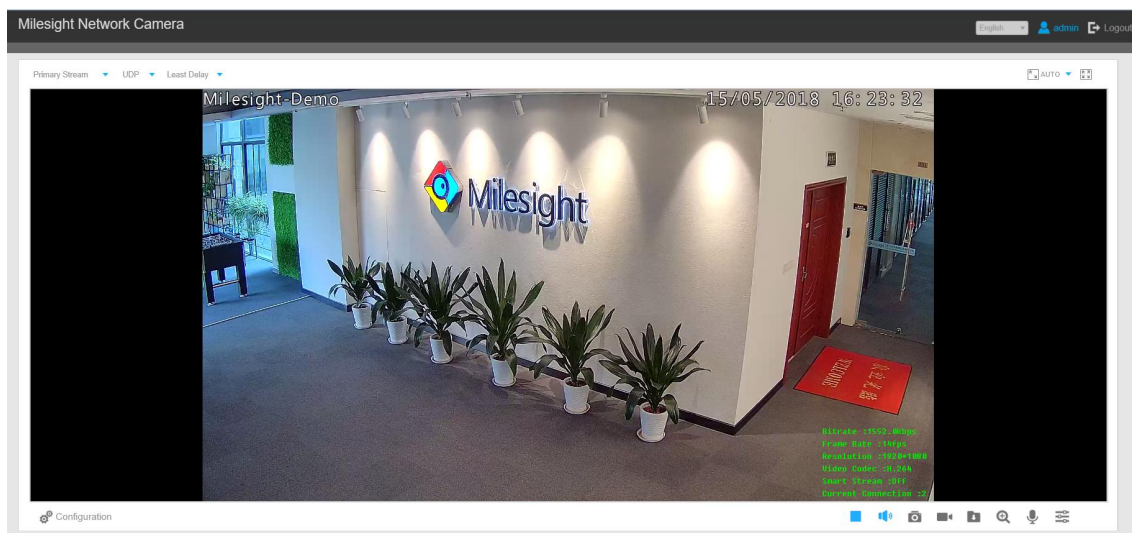

3.2.2 Access without Plugin

As browser security becomes more and more important, some browsers don't support installing plugin. In order to normally preview the video on the browser, Milesight upgraded the camera to support Plugin-Free Mode. In Plugin-Free Mode, you can preview the video on the browser without plugin. Currently Plugin-Free Mode is supported in Firefox & Google Chrome & Safari & Edge browser for Windows system, MAC system, iOS system and Android system. Both H.265&H.264 video codec are supported in Plugin-Free Mode for camera, and it will play the secondary stream by default.

Note:

- 1) You need to upgrade camera to V4x.7.0.70 or above to use Plugin-Free Mode.
- 2) For the firmware which below V4x.7.0.74, please upgrade the Network Camera to V4x.7.0.74 or above (Please upgrade the browser to the latest version).
- 3) For V4x.7.0.74 or above, you can enjoy Plugin-Free Mode without any configuration about the browser (Please upgrade the browser to the latest version).

You can preview the video without plugin by selecting Plugin-Free Mode in Live View interface.

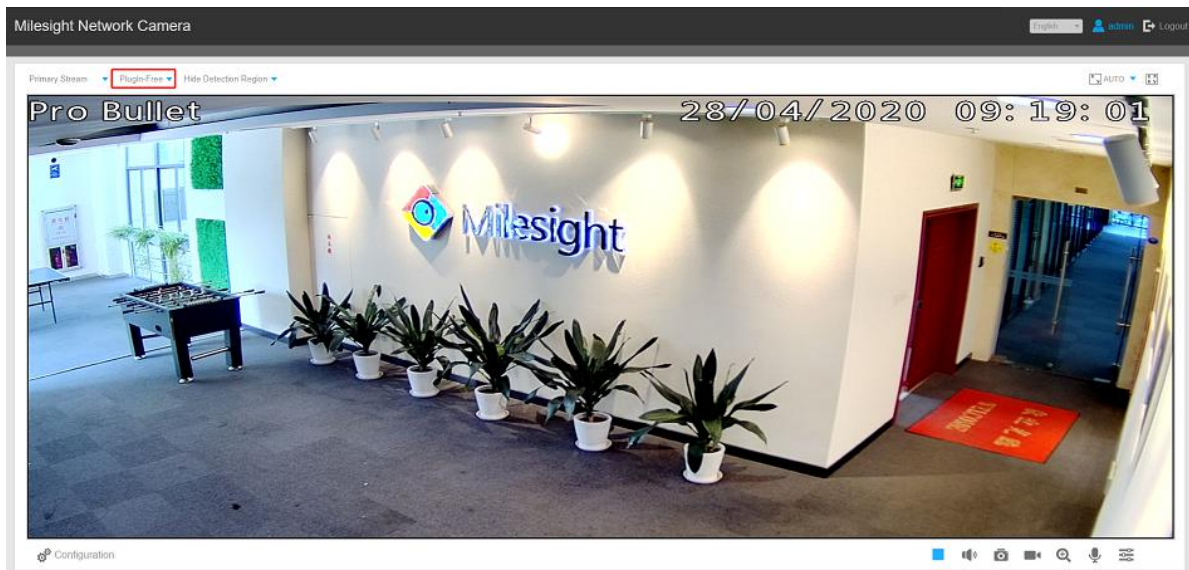

It supports previewing the video in Live View and other setting interfaces.

3.3 Accessing from Milesight VMS (Video Management Software)

Milesight VMS(ONVIF compatible) is a handy and reliable application designed to work with network cameras in order to provide video surveillance, recording settings and event management functions. The interface of Milesight VMS is very easy to use, intuitive, with easy access to the most common activities, such as viewing live video, searching through recordings and exporting videos and snapshots. It's able to be integrated with other devices through ONVIF. It is designed to work on Windows XP/ 7/ 8/ Vista/ Server 2000/ Server 2008. The software could be downloaded from our website www.milesight.com.

Please install Milesight VMS; then launch the program to add the camera to the channel list. For detailed information about how to use the software, please refer to user manual of Milesight VMS.

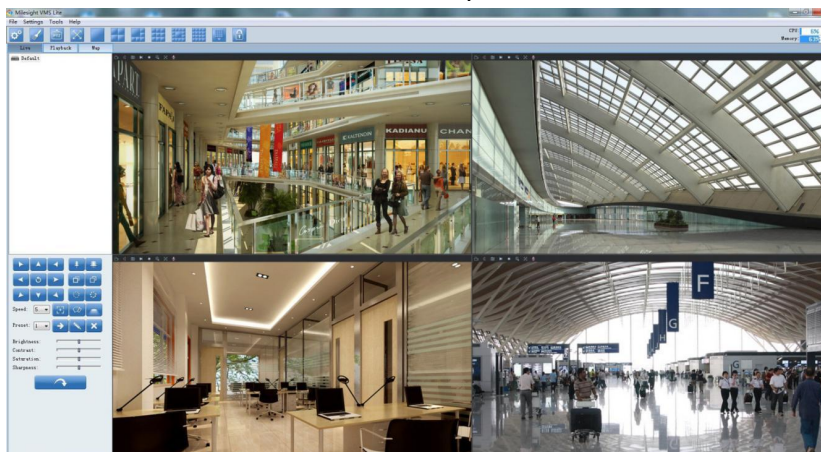

Milesight VMS Live View

Chapter IV System Operation Guide

4.1 Live Video

After logging in the network camera web GUI successfully, user is allowed to view live video as follows.

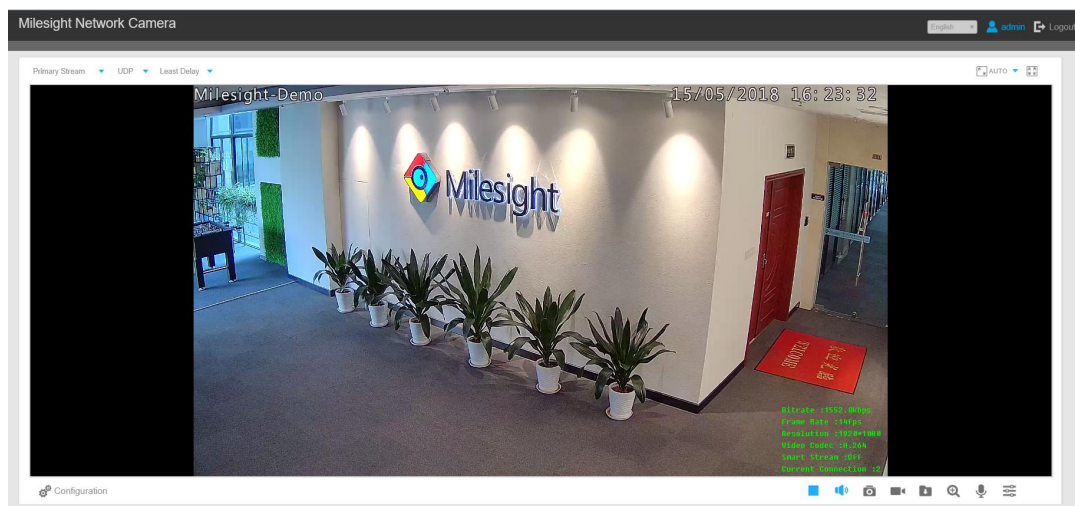

Table 4-1-1 Description of the buttons

No.	Parameter	Description
1	<p>Image Config</p>	<p>Brightness: Adjust the Brightness of the scene</p> <p>Contrast: Adjust the color and light contrast</p> <p>Saturation: Adjust the Saturation of the image.Higher Saturation makes colors appear more "pure" while lower one appears more "wash-out"</p> <p>Sharpness: Adjust the Sharpness of image. Higher Sharpness sharps the pixel boundary and makes the image looks "more clear"</p> <p>2D DNR/3D DNR: Adjust the noise reduction level</p> <p>Default: Restore brightness, contrast and saturation to default settings</p>
2		Click to access the configuration page
3		Choose the Stream (Primary/Secondary/Tertiary) to show on the current video window
4		Only available for camera whose software version is 43 or above Web Components: Support Firefox, Safari, Chrome

		<p>(Chrome version 44 or below); need to install the component to display the view;</p> <p>MJPEG: Support to display the view on Firefox, Safari, Chrome (Chrome version 45 or above);</p> <p>(NOTE: IE choose Web Components mode for default, in this case, it will not show the options)</p>
5		<p>TCP: More reliable connection;</p> <p>UDP: More instantaneous connection, but if you cannot get the live view successfully, please turn into TCP connection;</p> <p>HTTP: Faster and safer connection especially in Internet environment.</p>
6		<p>Least Delay: The most instantaneous mode;</p> <p>Balanced: A balanced mode between Least Delay and Best Fluency, maintains the fluency while keeps an acceptable delay;</p> <p>Best Fluency: The most fluent mode;</p>
7	<p>Window size</p>	Click to display images at a window size
8	<p>Real size</p>	Click to display images at a real size
9	<p>Full Screen</p>	Click to display images at full-screen
10	<p>Recording</p>	When recording, the icon will turn red
11	<p>Alarm</p>	When an alarm of Smart Event was triggered, the icon appears
12	<p>Alarm</p>	When an alarm of Motion Detection was triggered, the icon appears
13	<p>Alarm</p>	Except for the two kinds of alarms above, when other alarms were triggered, the icon appears
		Adjust the Zoom length of the lens (Only work when your camera is equipped with motorized lens)
		Adjust focus of the lens (Only work when your camera is equipped with motorized lens)
		Adjust the size of Iris (Only work when your camera is equipped with P-Iris)
		Auxiliary Focus and Lens Initialization (Only work when your camera is equipped with motorized lens)

		Adjust iris automatically if check this box (Only work when your camera is equipped with P-Iris)
14		Start/Stop live view
15	 Capture	Click to capture the current image and save to the configured path. The default path is C:\VMS\+-1\ IMAGE-MANUAL
16	 Start Recording	Click to start recording video and save to the configured path. The default path is C:\VMS\+-1\MS_Record. Click again to stop recording
17	 Play Audio	Enable Audio Input/Output. It can also be set in Audio configuration page
18	 Saving Path Settings	Set the saving path for captured images and video recordings of operating on the live view
19	 Enable Digital Zoom	When enabled, you can zoom in in a specific area of video image with your mouse wheel
20	 Start Talking	When it is enabled, you can start real-time talking.
21		Click to select system language

4.2 Playback

This section explains how to view the recorded video files stored in SD cards or NAS.

Step1: Click [Playback] on the menu bar to enter playback interface;

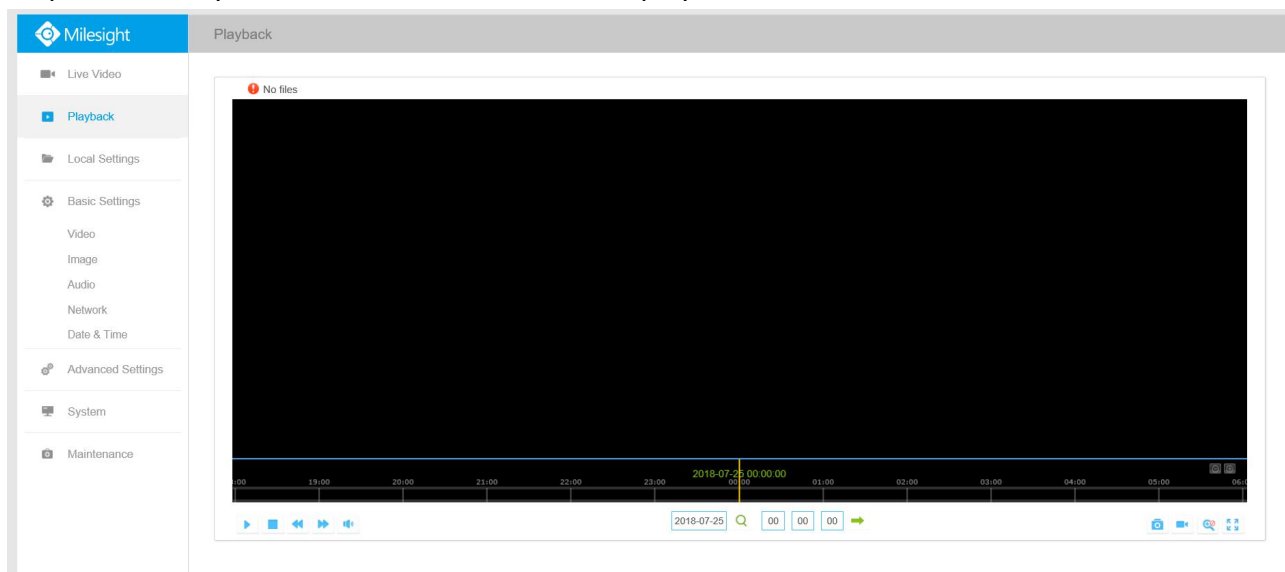

Step2: Click the date button, choose the date when date window pops up;

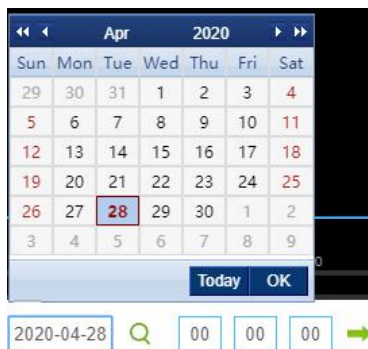

Note:

- 1) The date with bright red means current date; one with a dark red number and white background means weekend day; one with a dark red number and blue background means that the date is selected now.
- 2) It supports Plugin-free Playback function which allows to preview the playback without installing plugin in Firefox (Version 65 and above) & Google Chrome (Version 69 and above) ; You need to configure the browser properties before using this function. Please refer to **3.2.2 Access without Plugin** for more browser configuration.

Step3: Click  to play the video files found on this date.

The toolbar on the button of playback interface can be used to control playing progress.

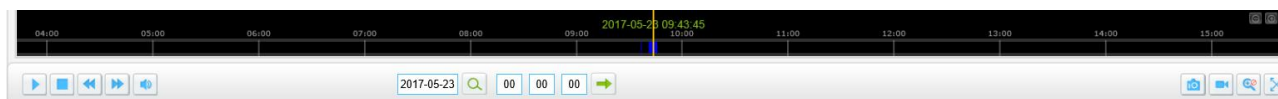

Playback Toolbar

Table 4-2-1 Description of the buttons

Button	Operation
	Play
	Pause
	Stop
	Speed Down
	Speed Up
	Audio On/Off
	Search
	Go To

	Time Narrow/Expand
	Start/Stop Recording
	Snapshot
	Zoom On/Off
	Full Screen

Note:

- 1) Drag the progress bar with the mouse to locate the exact playback point. You can also input the time and click to locate the playback point in the *Set Playback Time* field. You can also click to zoom out/in the progress bar.



4.3 Local Settings

Record File Length and storage path can be customized in this setting page.

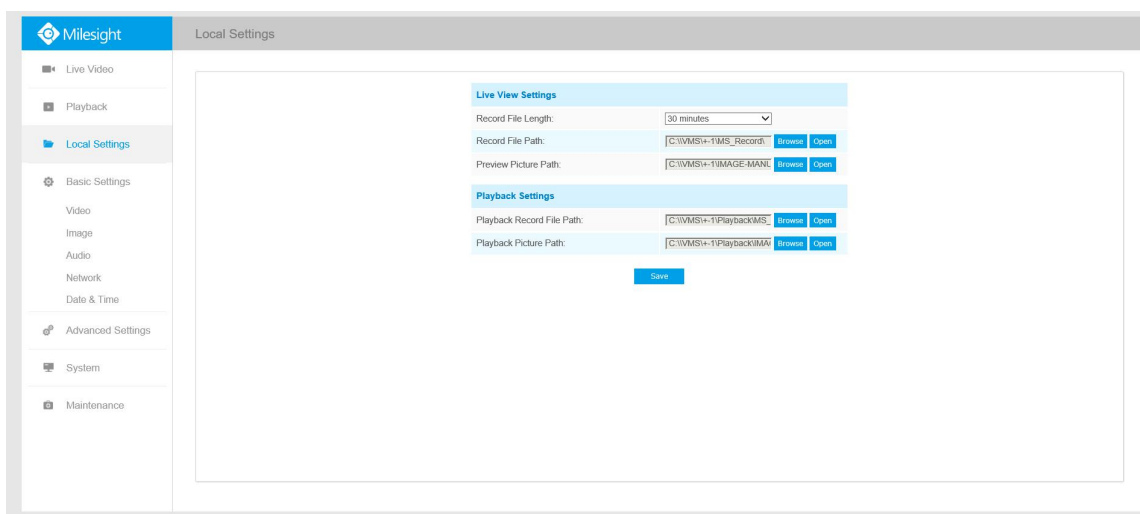

4.4 Basic Settings

4.4.1 Video

Stream parameters can be set in this module, adapting to different network environments and demands.

Primary Stream Settings

Basic Settings >> Video

Primary Stream Secondary Stream Tertiary Stream

Record Stream Type :	General
Video Codec :	H.264
Frame Size :	1080P(1920*1080)
Maximum Frame Rate :	25 fps
Bit Rate :	4096 kbps
Smart Stream :	On
Level :	5
Bit Rate Control :	CBR
Profile :	Main
I-frame Interval :	50 frame(1-120)

Save

Record Stream Type (General)

Basic Settings >> Video

Primary Stream Secondary Stream Tertiary Stream

Record Stream Type :	Event
Enable Event Stream :	<input checked="" type="checkbox"/>
Video Codec :	H.264
Frame Size :	1080P(1920*1080)
Maximum Frame Rate :	25 fps
Bit Rate :	4096 kbps
Smart Stream :	Off
Bit Rate Control :	CBR
Profile :	Main
I-frame Interval :	50 frame(1-120)

Save

Record Stream Type (Event)

Secondary Stream Settings

Basic Settings >> Video

Primary Stream **Secondary Stream** Tertiary Stream

Enable:	<input checked="" type="checkbox"/>
Video Codec:	H.265
Frame Size:	640*480
Maximum Frame Rate:	25 fps
Bit Rate:	512 kbps
Smart Stream:	On
Level:	5
Bit Rate Control:	CBR
Profile:	Main
I-frame Interval:	50 frame(1-120)

Save

Tertiary Stream Settings

Basic Settings >> Video

Primary Stream Secondary Stream **Tertiary Stream**

Enable:	<input checked="" type="checkbox"/>
Video Codec:	H.264
Frame Size:	640*480
Maximum Frame Rate:	25 fps
Bit Rate:	1024 kbps
Smart Stream:	On
Level:	5
Bit Rate Control:	CBR
Profile:	Main
I-frame Interval:	50 frame(1-120)

Save

Table 4-4-1 Description of the buttons

Parameters	Function Introduction
------------	-----------------------

Record Stream Type	<p>General & Event are available only for Primary Stream. General refers to continuous record video, while Event includes events that can trigger alarms, such as Motion, Exception, LPR and so on.</p> <p>This item can separately set different bit rate and frame rate for different Recording Stream Types. If user chooses Event, video will be recorded according to the configuration of video stream type when an event happens, thereby greatly reducing the recording storage space.</p>
Enable Event Stream	<p>This item is optional only if you selected the Event.</p>
Video Codec	<p>There are differences for the camera with “-A” and “-B”</p> <p>-A: H.264/MJPEG are available</p> <p>-B: H.265/H.264/MJPEG are available</p>
Frame Size	<p>Options include 8M(3840×2160), 6M(3072×2048), 5M(2592*1944), 5M(2560*1920), 5M(2560*1440), 4M(2592*1520), 3M(2304*1296), 3M(2048*1536), 1080P(1920*1080), 2M(1600 *1200), 1.3M(1280*960), 720P(1280*720), D1(704*576).</p> <p>For Secondary Stream, it includes 704*576, 640*480, 640*360, 352*288, 320*240, 320*192, 320*176.</p> <p>For Tertiary Stream, it include 1920*1080, 1280*720, 704*576, 640*480, 640*360, 352*288, 320*240, 320*192, 320*176.</p>
Maximum Frame Rate	<p>Maximum refresh frame rate of per second</p>
Bit Rate	<p>Transmitting bits of data per second, this item is optional only if you select the H.265/H.264</p>
Smart Stream	<p>Smart Stream mode remarkably reduces the bandwidth and the data storage requirements for network cameras while ensuring the high quality of images, and it is a 10-level adjustable codec.</p> <p>It is optional to turn On/Off Smart Stream mode.</p> <p>Level: Level 1~10 are available to meet your need.</p>
Bit Rate Control	<p>CBR: Constant Bitrate. The rate of CBR output is constant</p> <p>VBR: Variable Bitrate. VBR files vary the amount of output data per time segment</p>
Image Quality	<p>Low/Medium/High are available, this item is optional only if you select VBR.</p>
Profile	<p>The option is for H.264, Main/High/Base can be selected according to your needs.</p>

I-frame Interval	Set the I-frame interval to 1~120, 50 for the default. This item is optional only if you select the H.265/H.264. The number must be a multiple of the number of frames.
JPEG Quality	Low/Medium/High/Higher are available, this item is optional only if you selected the MJPEG

Note:

1) The options of [Frame Size] are variable according to the model selected.

4.4.2 Image

Display information, enhancement of image and Day/Night setting can be set in this module. OSD (On Screen Display) content and video time can be displayed to rich the image information.

Display

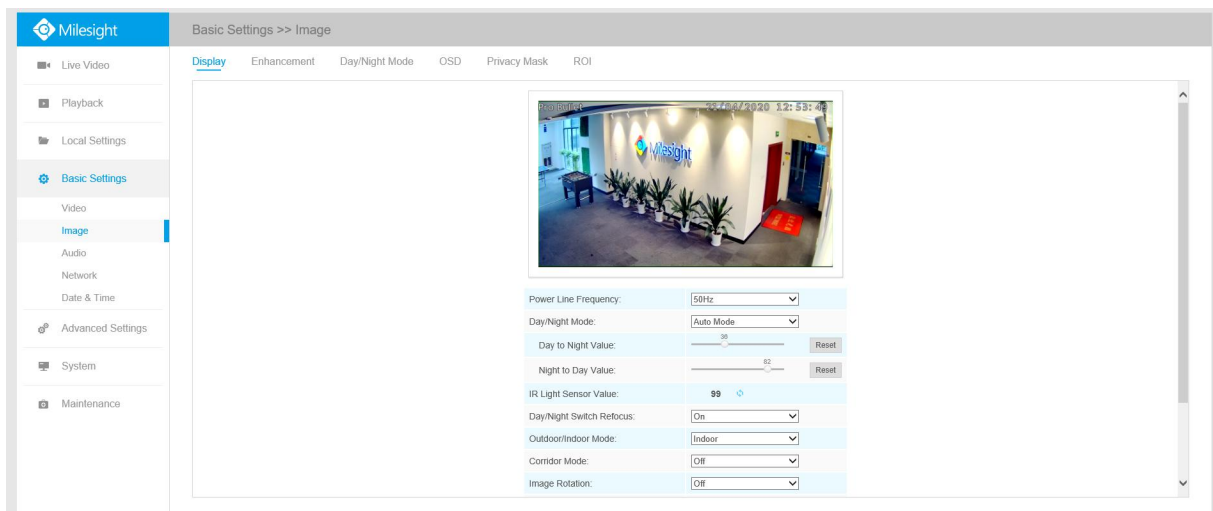
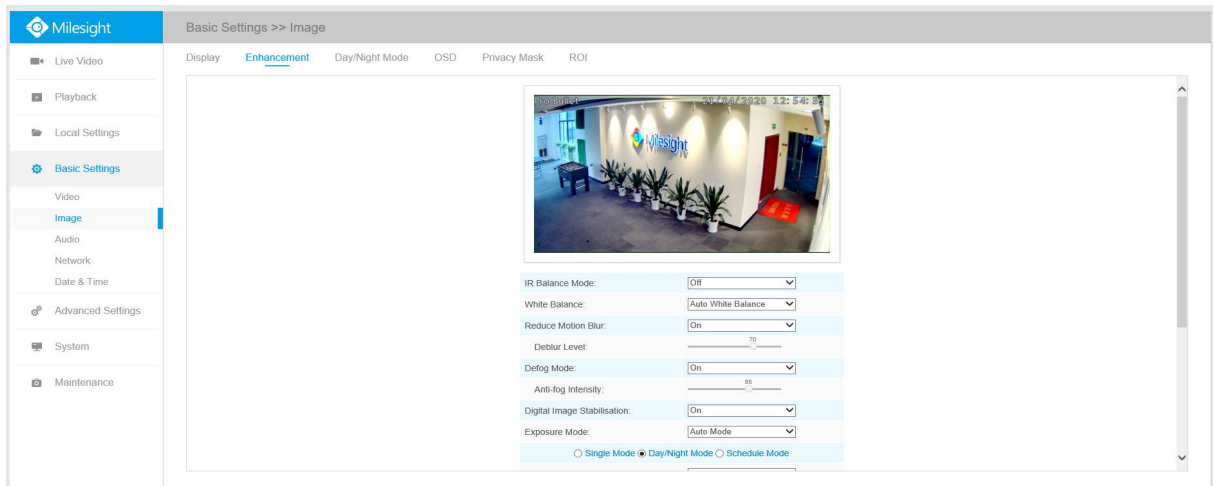

Table 4-4-2 Description of the buttons

Parameters	Function Introduction
Power Line Frequency	60Hz flicker for 30fps camera model and 50Hz flicker for 25fps camera model
Day/Night Mode	<p>There are several parameters such as Exposure Level, Maximum Exposure Time and IR-CUT Interval, etc, associated with this mode</p> <p>Night Mode: Shown in live view based on Night Mode settings</p> <p>Day Mode: Shown in live view based on Day Mode settings</p> <p>Auto Mode: Shown in live view based on environment, set the sensitivity for switching Day Mode to Night Mode, or Night Mode to Day Mode</p> <p>Customize: Shown in live view based on your own settings' time to start/end Night Mode</p>

Day To Night Value	This is the sensitivity for switching Day Mode to Night Mode . When IR Light Sensor Current Value is lower than this value, it will switch Day Mode to Night Mode
Night To Day Value	This is the sensitivity for switching Night Mode to Day Mode . When IR Light Sensor Current Value is higher than this value, it will switch Night Mode to Day Mode
IR Light Sensor Value	The current value of the IR light sensor
Smart IR Mode	With the combination of the High Beam and Low Beam, The IR LEDs technology has been upgraded to provide better image clarity and quality regardless of the object distance. Also, the Low Beam and High Beam's brightness can be adjusted manually or automatically on the basis of the Zoom ratio. Moreover, with the IR anti-reflection panel, the infrared light transmittance is highly increased. Support to set the strength of the IR to Auto Mode or Customize to achieve the best effect.
Near view level	Adjust the light strength of Low-Beams LED light level from 0 to 100.
Far view level	Adjust the light strength of High-Beams LED light level from 0 to 100.
IR Strength Value	The current value of Low-Beams LED and High-Beams LED light value
Day/Night Switch Refocus	With this option enabled, the camera will refocus when switching between day mode and night mode.
Outdoor/Indoor Mode	Select indoor or outdoor mode to meet your needs
Corridor Mode	There are three options available, you can select one to meet your need Off: Keep the image in normal direction Clockwise 90°: Rotate the image by 90° clockwise Anticlockwise 90°: Rotate the image by 90° anticlockwise
Image Rotation	There are four options available, you can select one to meet your need Off: Keep the image in normal direction Rotating 180°: Upside down the image Flip Horizontal: Flip the image horizontally Flip vertical: Flip the image vertically
Local Display Video (Only for Pro Bullet)	Select NTSC or PAL for local display
Smoked Dome Cover	This function is only for Pro Dome. If Pro Dome is equipped with a Smoked Dome Cover, enable this function to display a normal image.
Lens distort correct (Only for 180° Panoramic Mini Bullet)	There are two options available, you can select one to meet your need Off: Select the original image of 180° Panoramic Mini Bullet On: Select the dewarping image of 180° Panoramic Mini Bullet

Enhancement



Enhancement

Table 4-4-3 Description of the buttons

Parameters	Function Introduction
IR Balance Mode	There is an option to turn On/Off the IR LED. IR Balance Mode would avoid the problem of overexposure and darkness, and the IR LED will change according to the actual illumination.
White Balance	To restore white objects, removed color distortion caused by the light of the environment Auto White Balance: This option will automatically enable the White Balance function Manual White Balance: This option is only for H.265 series. Set Red Gain Level and Blue Gain Level manually. Incandescent Lamp: Select this option when light is similar with incandescent lamp Warm Light Lamp: Select this option when light is similar with warm light lamp Natural Light: Select this option when there is no other light but natural light Fluorescent Lamp: Select this option when light is similar with Fluorescent Lamp Schedule mode: Select this option that you can customize the schedule to enable/disable above modes
Reduce Motion Blur	Enable this function to reduce the motion blur of objects effectively. You can adjust the deblur level from 1 to 100.
Defog Mode	Better image effect in foggy weather, refers to Figure 4-4-10
Digital Image Stabilisation	Decrease the blur and shakiness of the image.
Exposure Mode	Auto Mode, Manual Mode and Schedule Mode are available. Auto Mode: The camera will adjust the brightness according to the light environment automatically; Manual Mode: The camera will adjust the brightness according to the value you set, you can set the exposure time from 1~1/100000s, the higher

	<p>the value is, the brighter the image is;</p> <p>Schedule Mode: You can customize the schedule to enable/disable Auto Mode and Manual Mode.</p>
Single Mode	Set single mode for BLC/WDR/HLC.
Day/Night Mode	Support BLC/WDR/HLC on Day Enhancement Mode/Night Enhancement Mode separately.
Schedule Mode	Set schedule mode for BLC/WDR/HLC.
BLC Region	<p>Off, Customize, and Centre are available (in single mode, only enable when WDR is disable)</p> <p>Off: Calculate the full range of view and offer appropriate light compensation</p> <p>Customize: This option enables you to customize inclusive or exclusive region manually</p> <p>Centre: This option will automatically add an inclusive region in the middle of the window and give the necessary light compensation</p>
Wide Dynamic Range	<p>This function which can capture and display both bright and dark areas in the same frame enables details of objects in both bright and dark areas to be visible.</p> <p>Off: Disable WDR function</p> <p>On: Enable the WDR, there are Low/High/Auto three levels</p> <p>Customize: Customize the schedule to enable/disable the WDR function and set the levels with Low/High/Auto</p>
Wide Dynamic Level	Set WDR with Low/High/Auto level
Anti-flicker Level	Reduce flickers that appear on screen in some lighting conditions and there are 10 levels of anti-flicker adjustments
High Light Compensation	<p>This function is only for H.265 series to adjust the brightness to a normal range when the light is strong, refers to Figure 4-4-11</p> <p>Off: Disable HLC function</p> <p>General Mode: Enable the general mode of HLC, and there is a setting for HLC Level</p> <p>Enhanced Mode: Enable the enhanced mode of HLC, and there is a setting for HLC Level</p>
HLC Level	Select level for HLC
Day Enhancement Mode	BLC/WDR/HLC are available.
Night Enhancement Mode	BLC/WDR/HLC are available.
Schedule Setting	Customize the schedule to enable/disable BLC/WDR/HLC mode

Note:

- 1) You can customize the schedule to enable/disable the difference White Balance modes.

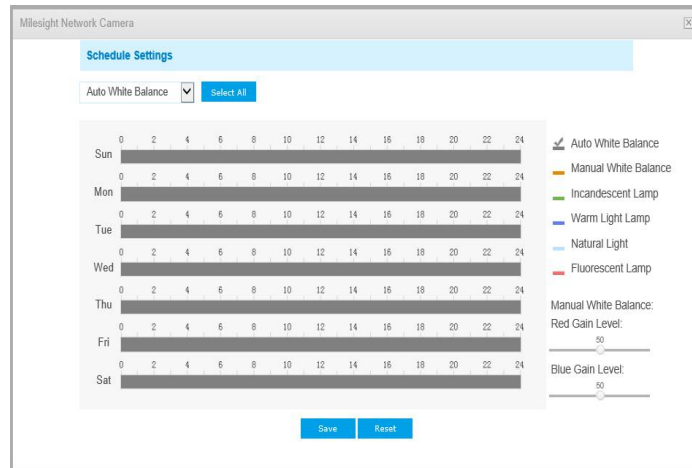

2) You can customize the schedule to enable/disable the difference exposure modes.

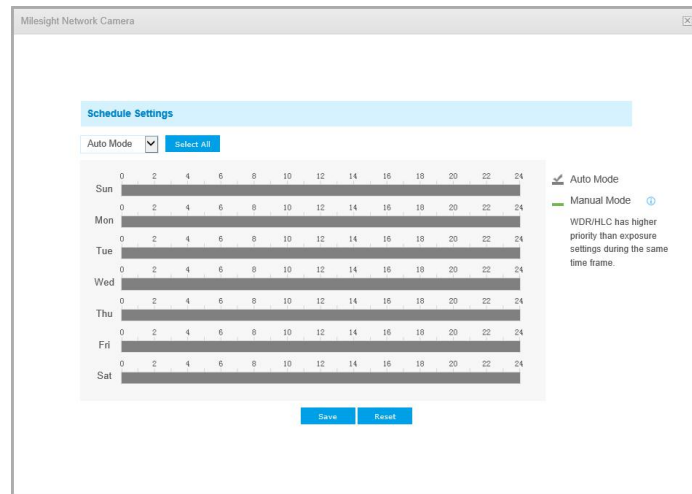

3) You can customize the schedule to enable/disable BLC/WDR/HLC mode.

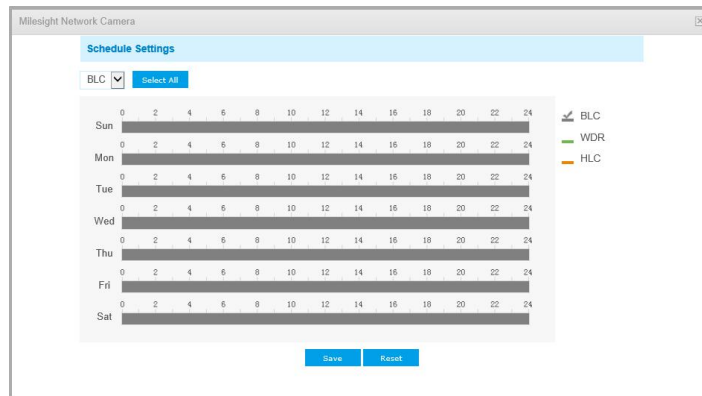

4) WDR/HLC has higher priority than exposure settings at the same time frame.

5) Defog Image.



6) HLC Image.



Day/Night Mode

Milesight

Basic Settings >> Image

- Live Video
- Playback
- Local Settings
- Basic Settings
 - Video
 - Image
 - Audio
 - Network
 - Date & Time
- Advanced Settings
- System
- Maintenance

Display
Enhancement
Day/Night Mode
OSD
Privacy Mask
ROI

Day/Night Mode								
Day/Night Mode	Exposure Level	Minimum Shutter	Maximum Shutter	Limit Gain Level	IR-CUT Latency	IR-CUT	IR LED	Color Mode
Night Mode	5	1/25	1/1000000	100	5s	Off	On	B/W
Day Mode	5	1/25	1/1000000	100	5s	On	Off	Color

Schedule Mode								
Timer	Exposure Level	Minimum Shutter	Maximum Shutter	Limit Gain Level	IR-CUT Latency	IR-CUT	IR LED	Color Mode
<input type="checkbox"/> 00:00:00 - 24:00:00	5	1/25	1/1000000	100	5s	Off	On	B/W
<input type="checkbox"/> 00:00:00 - 24:00:00	5	1/25	1/1000000	100	5s	Off	On	B/W
<input type="checkbox"/> 00:00:00 - 24:00:00	5	1/25	1/1000000	100	5s	Off	On	B/W
<input type="checkbox"/> 00:00:00 - 24:00:00	5	1/25	1/1000000	100	5s	Off	On	B/W
<input type="checkbox"/> 00:00:00 - 24:00:00	5	1/25	1/1000000	100	5s	Off	On	B/W

Table 4-4-4 Description of the buttons

Parameters	Function Introduction
------------	-----------------------

Exposure Level	Level 0~10 are available to meet your need
Minimum Shutter	Minimum Shutter is the same as Maximum Exposure Time. Set the minimum Shutter to 1~1/100000s
Maximum Shutter	Maximum Shutter is the same as Minimum Exposure Time. Set the maximum Shutter to 1~1/100000s
IR-CUT Latency	The interval time of switching one mode to another
IR-CUT	Turn on or turn off IR-CUT
IR LED	Turn on or turn off IR-LED
Color Mode	Select B/W or Color mode under Day/Night mode
Schedule Mode	Here you can customize your special demands for different time, then the Day mode and Night mode will switch automatically according to your settings

On Screen Display(OSD)

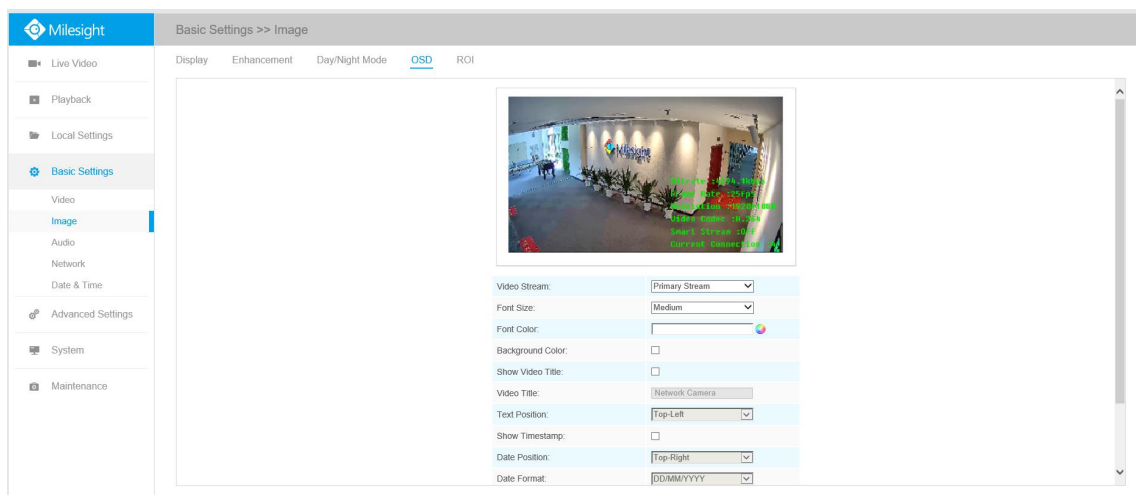
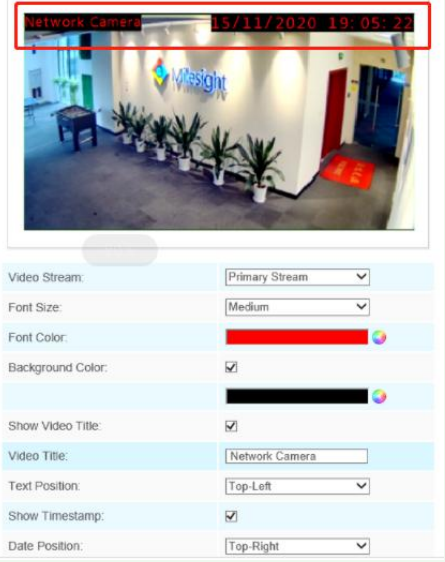

Table 4-4-5 Description of the buttons

Parameters	Function Introduction
Video Stream	Enable to set OSD for primary stream and secondary stream
Font Size	Smallest/Small/Medium/Large/Largest/Auto are available for title and date
Font Color	Enable to set different color for title and date
Background Color	Enable to set different colors for display information background on screen You can set different colors for font and background of image , then the image OSD will show as below:



Note: Background color can not be the same with font color

Show Video Title	Check the checkbox to show video title
Video Title	Customize the OSD content
Text Position	OSD display position on the image
Show Timestamp	Check the checkbox to display date on the image
Date Position	Date display position on the image
Date Format	The format of date
Copy to Other Streams	Copy the settings to other streams

Privacy Mask

Privacy mask enables to cover certain areas on the live video to prevent certain spots in the surveillance area from being viewed and recorded. You can set 8 mask areas at most.

Milesight

Basic Settings >> Image

- Live Video
- Playback
- Local Settings
- Basic Settings
- Video
- Image
- Audio
- Network
- Date & Time
- Advanced Settings
- System
- Maintenance

Display
Enhancement
Day/Night Mode
OSD
Privacy Mask
ROI



Enable:

Type: Blank

ID	Name	Enable	Delete
1	Mask1	<input checked="" type="checkbox"/>	✖

Note: Support up to 8 Privacy Mask areas.

Table 4-4-6 Description of the buttons

Parameters	Function Introduction
Enable	Check the checkbox to enable the Privacy Mask function
Clear All	Clear all areas you drew before
Type	Select the color to use for the privacy areas, there are eight colors available: White, Black, Blue, Yellow, Green, Brown, Red and Violet

ROI

Region of interest (often abbreviated ROI), is a selected subset of samples within a dataset identified for a particular purpose. Users can select up to 8 key regions of a scene to transmit through separate streams for targeted preview and recording.

By using Milesight ROI technology, more than 50% of bit rate can be saved and therefore less bandwidth demanded and the storage usage reduced. So according to this, you can set a small bit rate for high resolution.

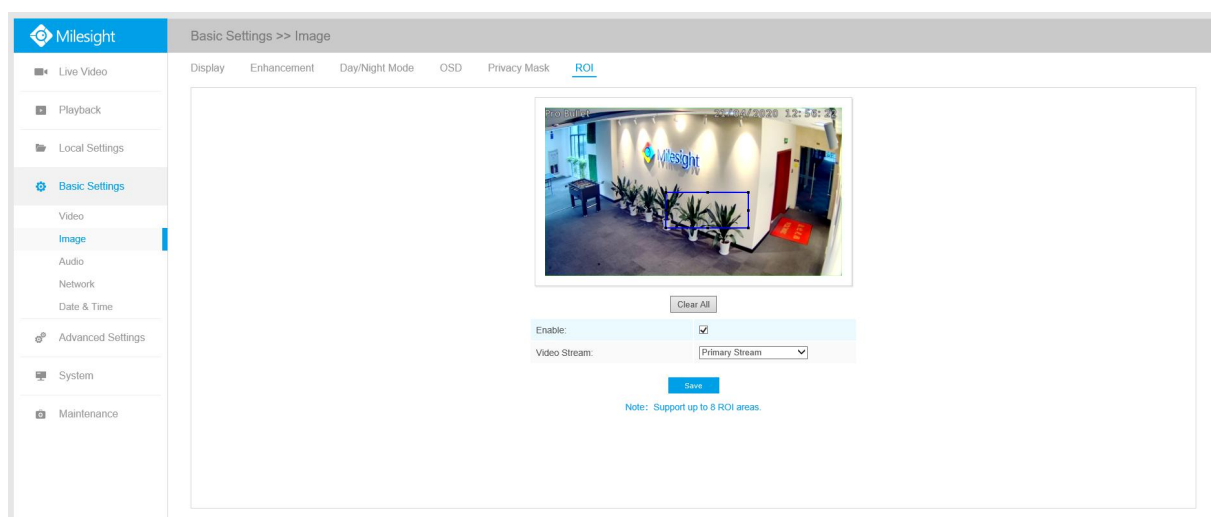

Table 4-4-7 Description of the buttons

Parameters	Function Introduction
Enable	Check the checkbox to enable the ROI function
Clear All	Clear all areas you drew before
Video Stream	Choose the Video Stream

Note:

You can set a low bit rate. For example, you can set a bit rate with 512Kbps and a resolution with 1080P, then you can see the image quality of ROI is more clear and fluent than the other region.

4.4.3 Audio

This audio function allows you to hear the sound from the camera or transmit your sound to the camera side. A two-way communication is also possible to be achieved with this feature. Alarm can be triggered when the audio input is above a certain alarm level you set, and configured audio can be played when an alarm occurs.



Enable Audio:	<input checked="" type="checkbox"/>
Audio Mode:	Both Audio Input & Output ▼

Audio Input	
Denoise:	<input type="checkbox"/>
Encoding:	AAC LC ▼
Sample Rate:	48KHz ▼
Audio Bit Rate:	144kbps ▼
Input Gain:	79 <input type="range"/>
Audio Output	
Auto Gain Control:	<input checked="" type="checkbox"/>
Output Volume:	76 <input type="range"/>

Save

Table 4-4-8 Description of the buttons

Parameters	Function Introduction
Enable Audio	Check on the check box to enable audio feature

Audio Input	<p>Denoise: Set it as On/Off. When you set the function on, the noise detected can be filtered</p> <p>Encoding: G.711-ULaw, G.711-ALaw, AAC LC, G.722 and G.726 are available</p> <p>Audio Bit Rate: The function is available only for AAC LC, and supports up to 256kbps</p> <p>Sample Rate: 8KHz, 16KHz, 32KHz, 44.1KHz, and 48KHz are available</p> <p>Input Gain: Input audio gain level, 0-100</p> <p>Alarm Level: Alarm will be triggered if voice alarm is enabled and input gained volume is higher than the alarm level, 1-100</p>
Audio Output	<p>Auto Gain Control: This function is only for H.265 series, improve the quality of audio</p> <p>Output Volume: Adjust volume of output</p>

Note:

- 1) 32KHz, 44.1KHz and 48KHz are available for 5MP, 4K camera models and 2MP@120fps camera models.

You can upload up to 5 audio files manually to Flash or SD Card on the Audio web page and you can also edit the audio file's name when upload.

Audio File Storage Type:

Audio File Upload

Audio File Name:

Audio File:

ID	Audio File Name	Delete
1	audio	<input type="button" value="✘"/>

Note: Only support '.wav' audio files with codec type PCM/PCMU/PCMA, 64kbps or 128kbps bitrate and no more than 500k!

Note:

- 1) The Audio mode and Audio Output are only for certain modules.
- 2) Only support '.wav' audio files with codec type PCM/PCMU/PCMA, 64kbps or 128 kbps and no more than 500k.

4.4.4 Network

TCP/IP

<input type="radio"/> Get IPv4 address automatically	
<input checked="" type="radio"/> Use fixed IPv4 address	
IP Address:	<input type="text" value="192 . 168 . 8 . 156"/> <input type="button" value="Test"/>
IPv4 Subnet Mask:	<input type="text" value="255 . 255 . 252 . 0"/>
IPv4 Default Gateway:	<input type="text" value="192 . 168 . 8 . 1"/>
Preferred DNS Server:	<input type="text" value="8 . 8 . 8 . 8"/>
IPv6 Mode:	<input type="text" value="Manual"/>
IPv6 Address:	<input type="text"/>
IPv6 Prefix:	<input type="text"/>
IPv6 Default Gateway:	<input type="text"/>

Table 4-4-9 Description of the buttons

Parameters	Function Introduction
Get IPv4 Address Automatically	Get an IP address from the DHCP server automatically
Use fixed IP address	<p>IPv4 Address: An address that used to identify a network camera on the network</p> <p>IPv4 Subnet Mask: It is used to identify the subnet where the network camera is located</p> <p>IPv4 Default Gateway: The default router address</p> <p>Preferred DNS Server: The DNS Server translates the domain name to IP address</p> <p>IPv6 Mode: Choose different mode for IPv6: Manual/Route Advertisement/DHCPv6</p> <p>IPv6 Address: IPv6 Address used to identify a network camera on the network</p> <p>IPv6 Prefix: Define the prefix length of IPv6 address</p> <p>IPv6 Default Gateway: The default router IPv6 address</p>

Note:

The **Test** button is used to test if the IP is conflicting.

HTTP

HTTP Enable:	<input checked="" type="checkbox"/>
HTTP Port:	<input type="text" value="80"/>
HTTPS Enable:	<input checked="" type="checkbox"/>
HTTPS Port:	<input type="text" value="443"/>
HTTPS Settings	
Installed Certificate:	<input type="text" value="C=US, H/IP=IPC"/> <input type="button" value="Reset"/>
Attributes:	<pre> Awarded to: C=US, H/IP=IPC Issuer: C=US, H/IP=IPC Period of Validity: Dec 18 06:46:09 2019 ~ Sep 12 06:46:09 2022 </pre>
Installation Type:	<input type="text" value="Create a Private Certificate"/> <input type="button" value="v"/>
Create a Private Certificate:	<input type="button" value="Create"/>
<input type="button" value="Save"/>	

Table 4-4-10 Description of the buttons

Parameters	Function Introduction
HTTP Enable	Start or stop using HTTP
HTTP Port	Web GUI login port, the default is 80, the same with ONVIF port
HTTPS Enable	Start or stop using HTTPS
HTTPS Port	Web GUI login port via HTTPS, the default is 443
HTTP Settings	Upload and set the SSL certificate .

HTTP URL are as below:

Stream	URL
Main Stream	http://username:password@IP:port/ipcam/mjpeg.cgi
Secondary Stream	http://username:password@IP:port/ipcam/mjpegcif.cgi
Tertiary Stream	http://username:password@IP:port/ipcam/mjpegthird.cgi

Note:

You need to change the codec type of streams to MJPEG except the main stream of H.264 cameras whose models with "-A".

RTSP

RTSP Port:	<input type="text" value="554"/>	
Playback Port:	<input type="text" value="555"/>	
RTP Packet:	<input type="text" value="Better Compatibility"/>	
Multicast Group Address:	<input type="text" value="239 . 6 . 6 . 6"/>	
QoS DSCP(0~63):	<input type="text" value="0"/>	

Save

Table 4-4-11 Description of the buttons

Parameters	Function Introduction
RTSP Port	The port of RTSP, the default is 554
Playback Port	The port of playback, the default is 555
RTP Packet	There are Better Compatibility and Better Performance two options, if your camera's image mess up, please switch this option
Multicast Group Address	Support multicast function
QoS DSCP	The valid value range of the DSCP is 0-63.

RTSP URL are as below:

Stream	URL
Main Stream	rtsp://username:password@IP:port/main
Secondary Stream	rtsp://username:password@IP:port/sub
Tertiary Stream	rtsp://username:password@IP:port/third

Note:

- 1) Get the format of RTSP URL by clicking " " on the right side of RTSP Port.
- 2) Get the playback tip by clicking " " on the right side of Playback Port.
- 3) DSCP refers to the Differentiated Service Code Point; and the DSCP value is used in the IP header to indicate the priority of the data.
- 4) A reboot is required for the settings to take effect.
- 5) The tertiary stream is only equipped on camera whose model with "-A" or "-B".

UPnP

Universal Plug and Play (UPnP) is a networking architecture that provides compatibility among networking equipment, software and other hardware devices. The UPnP protocol allows devices to connect seamlessly and to simplify the implementation of networks in the home and corporate environments. With the function enabled, you don't need to configure the port mapping for each port, and the camera is connected to the Wide Area Network via the router.

Enable UPnP:

Port Mapping

Enable Port Mapping:

Name:

Type:

Protocol Name	External Port	Internal Port	Status
HTTP	<input type="text" value="21202"/>	<input type="text" value="80"/>	Invalid
HTTPS	<input type="text" value="22202"/>	<input type="text" value="443"/>	Invalid
RTSP	<input type="text" value="23202"/>	<input type="text" value="554"/>	Invalid
Playback	<input type="text" value="25202"/>	<input type="text" value="555"/>	Invalid

Table 4-4-12 Description of the buttons

Parameters	Function Introduction
Enable	Check the checkbox to enable the UPnP function
Enable Port Mapping	Check the checkbox to enable the Port Mapping
Name	The name of the device detected online can be edited
Type	<p>Auto: Automatically obtain the corresponding HTTP, HTTPS, RTSP and Playback port, without any settings</p> <p>Manual: Need to manually set the appropriate HTTP port, HTTPS port, RTSP Port and Playback port. When choose Manual, you can customize the value of the port number by yourself</p>

DDNS

DDNS allows you to access the camera via domain names instead of IP address. It manages to change IP address and update your domain information dynamically. You need to register an account from a provider.

DDNS is not running

Enable DDNS:	<input type="checkbox"/>
Provider:	<input type="text" value="ddns.milesight.com"/>
External HTTP Port :	<input type="text" value="80"/>
External RTSP Port:	<input type="text" value="554"/>
External Playback Port:	<input type="text" value="555"/>
DDNS URL: http://ddns.milesight.com/210C1E	

Note: Recommend to enable and configure UPnP ports which can be used directly in DDNS.

You can choose “ddns.milesight.com” as provider for DDNS. After enabling it, you can access the device via the URL “http://ddns.milesight.com/MAC address” .

Table 4-4-13 Description of the buttons

Parameters	Function Introduction
Enable DDNS	Check the checkbox to enable DDNS service
Provider	Get support from DDNS provider: ddns.milesight.com, freedns.afraid.org, dyndns.org, www.no-ip.com, www.zoneedit.com. You can also customize the provider for DDNS.
Hash	A string used for verifying, only for "freedns.afraid.org"
User name	Account name from the DDNS provider, unavailable for "freedns.afraid.org"
Password	Account password, unavailable for "freedns.afraid.org"
Host name	DDNS name enabled in the account

Note:

- 1) Please do the Port Forwarding of HTTP Port and RTSP Port before you use Milesight DDNS.
- 2) Make sure that the internal and the external port number of RTSP are the same.

Email

Alarm video files can be sent to specific mail account through SMTP server. You must configure the email settings correctly before using it.

Enable:	<input type="checkbox"/>
User Name:	<input type="text" value="hdipnc"/>
Sender Email Address:	<input type="text" value="hdipnc@sina.com"/>
Password:	<input type="password" value="*****"/>
Email Server:	<input type="text" value="smtp.sina.com"/>
Email Port:	<input type="text" value="25"/>
Recipient Email Address1:	<input type="text" value="user@domain.com"/>
Recipient Email Address2:	<input type="text"/>
Encryption:	<input type="radio"/> SSL <input type="radio"/> TLS

Table 4-4-14 Description of the buttons

Parameters	Function Introduction
Enable	Check the checkbox to enable Email function
User Name	The sender's name. It is usually the same as the account name
Sender Email Address	Email address to send video files attached emails
Password	The password of the sender
SMTP Server	The SMTP server IP address or host name(e.g. smtp.gmail.com)
SMTP Port	The default TCP/IP port for SMTP is 25(not secured). For SSL/TLS port, it depends on the mail you use
Recipient Email Address1	Email address to receive video files
Recipient Email Address2	Email address to receive video files
Encryption	Check the checkbox to enable SSL or TLS if it is required by the SMTP server.

FTP

Alarm video files can be sent to specific FTP server. You must configure the FTP settings correctly before using it.

FTP Server Settings	
Server Address:	<input type="text" value="192.168.5.1"/>
Server Port:	<input type="text" value="21"/>
User Name:	<input type="text" value="admin"/>
Password:	<input type="password" value="*****"/>
FTP over SSL/TLS(FTPS):	<input type="checkbox"/>
FTP Storage Settings	
Storage Path:	<input type="text" value="Child Directory"/>
Parent Directory:	<input type="text" value="Date"/>
Child Directory:	<input type="text" value="IP Address"/>
Alarm Action File Name:	<input type="text" value="Customize"/>
Video File Name:	<input type="text" value="YYYY-MM-DD"/>
Image File Name:	<input type="text" value="YYYY-MM-DD"/>
Timing Snapshot File Name:	<input type="text" value="Default(YYYY-MM-DD)"/>
Pre-record:	<input type="text" value="0 second"/>

Table 4-4-15 Description of the buttons

Parameters	Function Introduction
Server Address	FTP server address
Server Port	The port of the FTP server. Generally it is 21
User Name	User name used to log in to the FTP sever
Password	User password
Storage Path	Storage Path where video and image will be uploaded to the FTP server. Four FTP storage path types are available, including Root Directory, Parent Directory, Child Directory and Customize.
Parent Directory	Choose IP Address/ Device Name/ Date as the folder name of Parent Directory, or customize the folder name.
Child Directory	Choose IP Address/ Device Name/ Date as the folder name of Child Directory, or customize the folder name.
Multilevel Folder Name	If the storage path is more than two levels, enter Multilevel FTP storage path here manually.
Alarm Action File Name	Choose the default(YYYY-MM-DD) or customize the alarm action file name.
Video File Name	If you choose to customize the alarm action file name, YYYY-MM-DD/ MM-DD-YYYY/ DD-MM-YYYY/ Add prefix are available.
Image File Name	If you choose to customize the alarm action file name, YYYY-MM-DD/ MM-DD-YYYY/ DD-MM-YYYY/ Add prefix are available.

Timing Snapshot File Name	Default(YYYY-MM-DD) /MM-DD-YYYY/ DD-MM-YYYY/ Add prefix/ Overwrite with the base file name are available.
----------------------------------	---

Note:

Parent Directory will be under Root Directory, and Child Directory will be under Parent Directory.

VLAN

A virtual LAN (VLAN) is any broadcast domain that is partitioned and isolated in a computer network at the data link layer (OSI layer 2). LAN is an abbreviation of local area network. VLANs allow network administrators to group hosts together even if the hosts are not on the same network switch. This can greatly simplify network design and deployment, because VLAN membership can be configured through software. Without VLANs, grouping hosts according to their resource needs necessitates the labour of relocating nodes or rewiring data links.

VLAN Enable:	<input checked="" type="checkbox"/>
VLAN ID(1~4094):	<input type="text" value="1"/>
VLAN IP:	<input type="text" value="- . - . -"/>
VLAN Netmask:	<input type="text" value="- . - . -"/>
VLAN Gateway:	<input type="text" value="- . - . -"/>

[Save](#)

Note:

How to set up VLAN in switches, please refers to your switches user manual.

PPPoE

This camera supports the PPPoE auto dial-up function. The camera gets a public IP address by ADSL dial-up after the camera is connected to a modem. You need to configure the PPPoE parameters of the network camera.

Enable PPPoE:	<input type="checkbox"/>
Dynamic IP:	<input type="text" value="0.0.0.0"/>
User Name:	<input type="text"/>
Password:	<input type="text"/>
Confirm Password:	<input type="text"/>

[Save](#)

Note:

- 1) The obtained IP address is dynamically assigned via PPPoE, so the IP address always changes after rebooting the camera. To solve the inconvenience of the dynamic IP, you need to get a domain name from the DDNS provider (e.g. DynDns.com).
- 2) The user name and password should be assigned by your ISP.

SNMP

You can set the SNMP function to get camera status, parameters and alarm related information and manage the camera remotely when it is connected to the network.

Before setting the SNMP, please download the SNMP software and manage to receive the camera information via SNMP port. By setting the Trap Address, the camera can send the alarm event and exception messages to the surveillance center.

SNMP v1/v2	
SNMP V1 Enable:	<input type="checkbox"/>
SNMP V2c Enable:	<input type="checkbox"/>
Write Community:	<input type="text" value="public"/>
Read Community:	<input type="text" value="private"/>
SNMP v3	
SNMP V3 Enable:	<input type="checkbox"/>
Read Security Name:	<input type="text"/>
Level of Security:	<input type="text" value="no auth,no priv"/>
Write Security Name:	<input type="text"/>
Level of Security:	<input type="text" value="no auth,no priv"/>
SNMP Port	
SNMP Port:	<input type="text" value="161"/>

Table 4-4-16 Description of the buttons

Parameters	Function Introduction
SNMP v1/2/3	The version of SNMP, please select the version of your SNMP software. SNMP v1: Provide no security SNMP v2: Require password for access SNMP v3: Provide encryption and the HTTPS protocol must be enabled
Write Community	Input the name of Write Community
Read Community	Input the name of Read Community
Read Security Name	Input the name of Read Security Community
Level of Security	There are three levels available: (auth, priv), (auth, no priv) and (no auth, no priv)
Write Security Name	Input the name of Write Security Community
Level of Security	There are three levels available: (auth, priv), (auth, no priv) and (no auth, no priv)
SNMP Port	The port of SNMP, the default is 161

Note:

- 1) The settings of SNMP software should be the same as the settings you configure here;
- 2) A reboot is required for the settings to take effect.

802.1x

The IEEE 802.1X standard is supported by the network cameras, and when the feature is enabled, the camera data is secured and user authentication is needed when connecting the camera to the network protected by the IEEE 802.1X.

Enable 802.1x:	<input checked="" type="checkbox"/>
Protocol:	EAP-MD5 ▾
Eapol Version:	1 ▾
User Name:	<input type="text"/>
Password:	<input type="text"/>
Confirm Password:	<input type="text"/>

[Save](#)

Bonjour

Bonjour is based on Apple's multicast DNS service. Bonjour devices can automatically broadcast their service information and listen to the service information of other devices.

If you don't know the camera information, you can use the Bonjour service on the same LAN to search for network camera devices and then to access the devices.

Enable Bonjour:	<input checked="" type="checkbox"/>
Bonjour Name:	MS-C2962-FPB-1CC316210991

[Save](#)

RTMP

Real-Time Messaging Protocol (RTMP) was initially a proprietary protocol for streaming audio, video and data over the Internet, between a Flash player and a server. RTMP is a TCP-based protocol which maintains persistent connections and allows low-latency communication. It can realize the function of live broadcast so that customers can log in to the camera wherever there is a network.

Enable RTMP:	<input checked="" type="checkbox"/>
Stream Type:	Secondary Stream ▼
Server Address:	rtmp://a.rtmp.youtube.com/

[Save](#)

For more information, please refer to ***Milesight-Troubleshooting-How to Use RTMP for Live Broadcast***

Note:

- 1) For YouTube live broadcast, if you use a newly created account to live broadcast, you need to wait for 24hrs to activate the account for using live function.
- 2) For RTMP, since G.711 is not available for YouTube, so you can only play video from Milesight Network Camera with H.264 video coding and AAC audio coding on YouTube.
- 3) Server Address in Network Camera RTMP interface needs to be filled with the format: rtmp://< Server URL >/< Stream key >, remember it needs '/'to connect between < Server URL > and < Stream key >.

4.4.5 Date&Time

Current System Time	
Date:	26/04/2020
Time:	14:49:33

Set the System Time	
Time Zone:	(UTC+08:00) China(Beijing, Hong Kong) ▼
Daylight Saving Time:	Disabled ▼
<input checked="" type="radio"/> NTP server	
Server Address:	192.168.14.101
NTP Sync:	<input checked="" type="checkbox"/> Interval: 1 day ▼
<input type="radio"/> Manual	
Time:	26/04/2020 14:48:34 
<input type="radio"/> Synchronize with computer time	
Date:	26/04/2020
Time:	14:49:35

[Save](#)

Current System Time

Current date&time of the system

Set the System Time

Table 4-4-17 Description of the buttons

Parameters	Function Introduction
Time Zone	Choose a time zone for your location
Daylight Saving time	Enable the daylight saving time
NTP server	Input the address of NTP server
NTP Sync	Regularly update your time according to the interval time
Manual	Set the system time manually
Synchronize with computer time	Synchronize the time with your computer

4.5 Advanced Settings

4.5.1 Alarm

Motion Detection

Step1: Check the checkbox to enable the motion detection;

Step2: Set motion region;

Enable Motion Detection:

Sensitivity:

Onvif Motion ActiveCells Settings:

Set Motion Region

Note: Please draw the screen for setting!

Table 4-5-1 Description of the buttons

Parameters	Function Introduction
Enable Motion	Check the checkbox to enable Motion Detection function

Detection	
Sensitivity	Sensitivity level, 1~10
Onvif Motion ActiveCells Settings	Normal and Compatible are available for the option. If the setting of motion region of the third-party software is different from ours, please set this option to Compatible.
Select All	Click the button, the motion in the area will be detected
Clear All	Click the button, the area drawn before will be removed

Step3: Set motion detection schedule;



Step4: Set alarm action;

Alarm Action	
Save Into Storage:	<input type="checkbox"/> File Format: Record <input type="button" value="v"/> (Please mount storage device.)
Upload Via FTP:	<input type="checkbox"/> File Format: Record <input type="button" value="v"/>
Upload Via SMTP:	<input type="checkbox"/> File Format: Snapsho <input type="button" value="v"/>
External Output:	<input type="checkbox"/> (Please configure the External Output Action Time.)
Play Audio:	<input type="checkbox"/> (Please configure the Audio Action Settings and Audio Interval.)
Alarm to SIP Phone:	<input type="checkbox"/> (Please open the SIP.)
HTTP Notification:	<input type="checkbox"/>

Table 4-5-2 Description of the buttons

Parameters	Function Introduction
Save Into Storage	Save alarm recording files into SD Card or NAS
Upload Via FTP	Upload the recording files via FTP
Upload Via SMTP	Upload the files via SMTP

External Output	If the camera equips with External Output, you can enable the action after configuring the trigger duration
Play Audio	If the camera equips with Speaker, you can enable the action after configuring the audio speaker
Play Buzzer	If the camera equips with Buzzer, you can check the checkbox to enable the function.
Alarm to SIP Phone	Support to call the SIP phone after enable the SIP function.
HTTP Notification	Support to pop up the alarm news to specified HTTP URL. Note: 1) Three HTTP notifications at most can be added to the same event. 2) HTTP Notification supports Basic & Digest authentication

NOTE:

- 1) **The HTTP notification function is just one way for camera to send messages to VMS Software.** And it's the VMS that defines what the messages mean and decides what to do after receiving this kind of messages. So, we can use the **HTTP Notification** function of our cameras only if the VMS supports this kind of message format.

Here will take the Digifort as an example to introduce the **HTTP Notification** function.

The following are the detail steps of setting for HTTP Notification in Digifort VMS and our cameras.

Step1: Enable Alarm, set Motion Region and detection Schedule;

Step2: Check the HTTP Notification as Alarm Action, and fill the fields. Then save the alarm setting. You can add up to three HTTP notifications to the same event;

HTTP Notification:	<input checked="" type="checkbox"/>
HTTP Notification URL:	URL 1
Enable:	<input checked="" type="checkbox"/>
Trigger Interval:	5 (0-900) s
URL:	192.168.8.75:8601/Interface/Cameras/MotionDetection/Notify?Camera=annie
User Name:	admin
Password:	••••••••

HTTP User Name: admin (the user name of your camera)

HTTP Password: ms1234 (the password of your camera)

HTTP Notification URL:

<http://IP:8601/Interface/Cameras/MotionDetection/Notify?Camera=CameraName>

IP refers to the PC's IP where the Digifort installed.

8601 is the port for Motion signal in Digifort.

CameraName is the camera name you set in Digifort VMS, like the picture shown below.

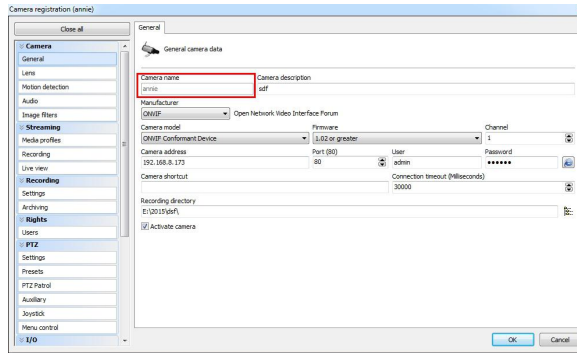

Example:

<http://192.168.8.75:8601/Interface/Cameras/MotionDetection/Notify?Camera=annie>, this URL format is exactly supported by Digifort VMS, so we can set as above to our cameras and get it work well.

Step3: choose use motion detection by external notification;

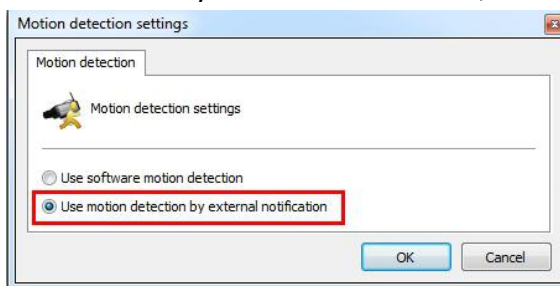

Step4: If successful, you can see the device icon turns yellow in the Surveillance when the camera is under Motion Detection Alarm;



So, it's the VMS Software which decides whether we can use this function successfully.

Step5: Set alarm settings.

Alarm Setting	
Record Video Sections:	5 seconds
Snapshot:	3
Snapshot Interval:	1 second
External Output Action Time:	30 seconds
Audio Action Settings:	Edit
Play Audio Interval:	Auto

[Save](#)

Table 4-5-3 Description of the buttons

Parameters	Function Introduction
Record Video Sections	Six different periods are available(5, 10, 15, 20, 25, 30 sec)
Snapshot	The number of snapshot, 1~5
Snapshot Interval	This cannot be edited unless you choose more than 1 to Snapshot
External Output Action Time	Length of time an alarm lasts, this cannot be edited unless you enable the External Output on the Alarm Action firstly.
Audio Action Settings	Set the audio schedule to trigger different audio files and action times in different time, which is corresponded to alarm action.
Play Audio Interval	Auto/ 10 seconds/ 30 seconds/ 1 minute/ 5 minutes/ 10 minutes are available.

Note:

You can customize the schedule of Audio Action.

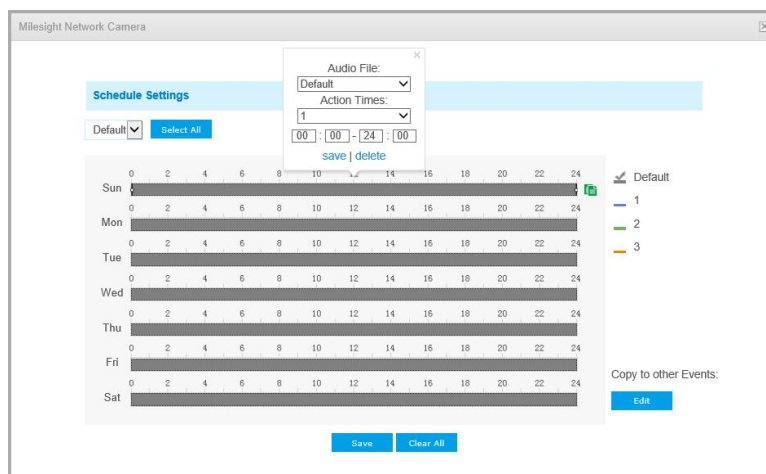

Audio Alarm

Enable the Audio before using Audio Alarm function.

Enable Audio Alarm:	<input type="checkbox"/>
Alarm Threshold:	<input type="range" value="28"/>
Audio Sample Value:	0



Schedule Settings

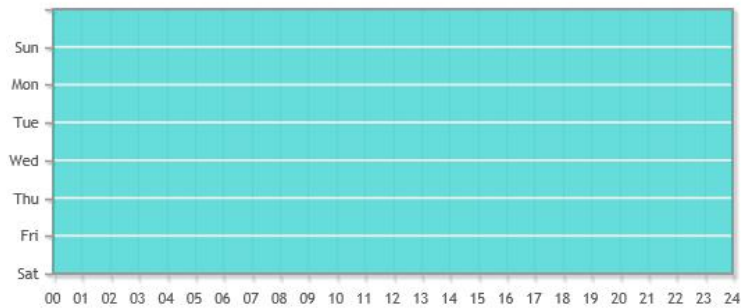

[Edit](#)

Alarm Action

Save Into Storage:	<input type="checkbox"/> File Format: <input type="text" value="Record"/> (Please mount storage device.)
Upload Via FTP:	<input type="checkbox"/> File Format: <input type="text" value="Record"/>
Upload Via SMTP:	<input type="checkbox"/> File Format: <input type="text" value="Snapsho"/>
External Output:	<input type="checkbox"/> (Please configure the External Output Action Time.)
Play Audio:	<input type="checkbox"/> (Please configure the Audio Action Settings and Audio Interval.)
Alarm to SIP Phone:	<input type="checkbox"/> (Please open the SIP.)
HTTP Notification:	<input type="checkbox"/>

Alarm Setting	
Record Video Sections:	5 seconds <input type="button" value="v"/>
Snapshot:	3 <input type="button" value="v"/>
Snapshot Interval:	1 <input type="text"/> second <input type="button" value="v"/>
External Output Action Time:	30 seconds <input type="button" value="v"/>
Audio Action Settings:	<input type="button" value="Edit"/>
Play Audio Interval:	Auto <input type="button" value="v"/>

The meaning of items please refer to table 4-5-2 and 4-5-3, here will not repeat again.

External Input

Enable External Input:	<input type="checkbox"/>
------------------------	--------------------------

Schedule Settings	
Sun	
Mon	
Tue	
Wed	
Thu	
Fri	
Sat	
	00 01 02 03 04 05 06 07 08 09 10 11 12 13 14 15 16 17 18 19 20 21 22 23 24

Alarm Action	
Save Into Storage:	<input type="checkbox"/> File Format: Record <input type="button" value="v"/> (Please mount storage device.)
Upload Via FTP:	<input type="checkbox"/> File Format: Record <input type="button" value="v"/>
Upload Via SMTP:	<input type="checkbox"/> File Format: Snapshot <input type="button" value="v"/>
External Output:	<input type="checkbox"/> (Please configure the External Output Action Time.)
Play Audio:	<input type="checkbox"/> (Please configure the Audio Action Settings and Audio Interval.)
Alarm to SIP Phone:	<input type="checkbox"/> (Please open the SIP.)
HTTP Notification:	<input type="checkbox"/>

Alarm Setting	
Record Video Sections:	5 seconds ▾
Snapshot:	3 ▾
Snapshot Interval:	1 second ▾
External Output Action Time:	30 seconds ▾
Audio Action Settings:	Edit
Play Audio Interval:	Auto ▾

[Save](#)

The meaning of items please refer to table 4-5-2 and 4-5-3, here will not repeat again.

External Output

External Output	
Normal Status:	<input type="radio"/> Open <input checked="" type="radio"/> Grounded
Current Status:	Grounded

[Test](#) [Save](#)

Please set the **Normal Status** firstly, when the **Current Status** is different with **Normal Status**, it will lead to the alarm.

Exception

Alarm Type	<input checked="" type="checkbox"/> Network Disconnected <input type="checkbox"/> IP Address Conflict <input type="checkbox"/> Record Failed <input type="checkbox"/> SD Card Full <input type="checkbox"/> SD Card Uninitialized <input type="checkbox"/> SD Card Error <input type="checkbox"/> No SD Card
Enable Network Disconnected Alarm:	<input type="checkbox"/>
Alarm Action	
Save Into Storage:	<input type="checkbox"/> File Format: Record <input type="button" value="v"/> (Please mount storage device.)
External Output:	<input type="checkbox"/> (Please configure the External Output Action Time.)
Play Audio:	<input type="checkbox"/> (Please configure the Audio Action Settings and Audio Interval.)
Alarm Setting	
Record Video Sections:	5 seconds <input type="button" value="v"/>
Snapshot:	3 <input type="button" value="v"/>
Snapshot Interval:	2 <input type="button" value="v"/> second <input type="button" value="v"/>
External Output Action Time:	30 seconds <input type="button" value="v"/>
Audio Action Settings:	<input type="button" value="Edit"/>
Play Audio Interval:	Auto <input type="button" value="v"/>
<input type="button" value="Save"/>	

Table 4-5-4 Description of the buttons

Parameters	Function Introduction
Alarm Type	<p>Network Disconnected, IP Address Conflicted, Record Failed, SD Card Full, SD Card Uninitialized, SD Card Error and No SD Card are available</p> <p>Check the checkbox to enable the alarm type you selected</p>
Alarm Action	<p>Save Into Storage: Save alarm recording files into SD Card</p> <p>Upload Via Email: Upload alarm recording files via email. This option is available for Record Failed, SD Card Full, SD Card Uninitialized, SD Card Error and No SD Card</p> <p>External Output: If the camera equips with External Output, you can enable the action after configuring the trigger duration</p> <p>Play Audio: If the camera equips with Speaker, you can enable the action after configuring the audio speaker</p> <p>Play Buzzer: If the camera equips with Buzzer, you can check the checkbox to enable the function</p>

Alarm Setting	<p>Record Video Sections: Six different periods are available(5, 10, 15, 20, 25, 30 sec)</p> <p>Snapshot: The number of snapshot, 1~5</p> <p>Snapshot Interval: This cannot be edited unless you choose more than 1 to Snapshot</p> <p>External Output Action Time: Length of time an alarm lasts, this cannot be edited unless when you enable the External Output on the Alarm Action firstly</p> <p>Audio Action Settings: Set the audio schedule to trigger different audio files and action times in different time, which is corresponded to alarm action</p> <p>Play Audio Interval: Auto/ 10 seconds/ 30 seconds/ 1 minute/ 5 minutes/ 10 minutes are available, this cannot be edited unless when you check the Play Audio checkbox firstly</p>
----------------------	--

4.5.2 Storage

Before you start:

To configure record settings, please make sure that you have the network storage device within the network or the SD card inserted in your camera.

Choose the storage mode according to your needs.

Storage Management

SD Card:



Table 4-5-5 Description of the buttons

Parameters	Function Introduction
Format	Format SD card, the files in SD card will be removed
Mount/UnMount	Mount/Dismount SD card
Delete	Enable cyclic storage, when the free disk space reach at a certain value, it will automatically delete the files at certain percentage according to your settings

NAS

The network disk should be available within the network and properly configured to store the recorded files, etc.

NAS (Network-Attached Storage), connecting the storage devices to the existing network, provides data and files services.

NAS Settings

Server Address:

File Path:

Mounting Type:

NFS ▼

Add

Table 4-5-6 Description of the buttons

Parameters	Function Introduction
Server Address	IP address of NAS server
File Path	Input the NAS file path, e.g. “\path”.
Mounting Type	NFS and SMB/CIFS are available. And you can set the user name and password to guarantee the security if SMB/CIFS is selected

Note:

Up to 5 NAS disks can be connected to the camera.

Record Settings

Storage Settings

Enable Recycle Storage:

Pre-record:

0 second ▼

Save

Schedule Settings

Edit

Table 4-5-7 Description of the buttons

Parameters	Function Introduction
Enable Recycle Storage	Enable/Disable Recycle Storage, if you enable this option, it will delete the files when the free disk space reach a certain value.
Pre-record	Reserve the record time before alarm, 0~10 sec

Files will be seen on this page when they are configured to save into SD card or NAS. You can set time schedule every day for recording videos and save video files to your desired location.

(Note: Files are visible once SD card is inserted. Don't insert or pull out SD card when power on.)

Video files are arranged by date. Set file type and start/end time to search out files. Each day files will be displayed under the corresponding date, from here you can copy and delete files etc. You can visit the files in SD card by ftp, for example, <ftp://username:password@192.168.5.190>(user name and password are the same as the camera account and the IP followed is the IP of your device.).

Show entries Download

<input type="checkbox"/>	File Name	Start Time	End Time	Type	Size
Please mount storage device first!					

File Search

Main Type:

Sub Type:

Start Time:

End Time:

Showing 0 to 0 of 0 entries

First Previous Next Last

4.5.3 Security

User

Manage Privilege

Allow Anonymous Viewing:

Security Question

Security Question:

Account Management

ID	User Name	Privilege
1	admin	Administrator

Admin Password:

User Level:

User Name:

Password:

Confirm:

User Privilege	
<input checked="" type="checkbox"/> All	
<input checked="" type="checkbox"/> Live Video	<input checked="" type="checkbox"/> Playback
<input checked="" type="checkbox"/> Local Settings	<input checked="" type="checkbox"/> Video Settings
<input checked="" type="checkbox"/> Audio Settings	<input checked="" type="checkbox"/> Image Settings
<input checked="" type="checkbox"/> Network Settings	<input checked="" type="checkbox"/> RTSP Access
<input checked="" type="checkbox"/> Date & Time	<input checked="" type="checkbox"/> Event Settings
<input checked="" type="checkbox"/> Storage Settings	<input checked="" type="checkbox"/> Storage Format
<input checked="" type="checkbox"/> Security Settings	<input checked="" type="checkbox"/> SIP Settings
<input checked="" type="checkbox"/> Logs	<input checked="" type="checkbox"/> System
<input checked="" type="checkbox"/> Maintenance	

Note: You can only add 20 users

Table 4-5-9 Description of the buttons

Parameters	Function Introduction
Manage Privilege	Allow anonymous viewing: Check the checkbox to enable visit from whom doesn't have account of the device
Security Question	<p>Click "Edit" button to set three security questions for your camera. In case that you forget the password, you can click "Forget Password" button on login page to reset the password by answering three security questions correctly.</p> <div style="border: 1px solid gray; padding: 10px; margin: 10px auto; width: 80%;"> <p style="text-align: center; margin: 0;">Milesight Network Camera</p> <p style="text-align: center; margin: 0;">Security Question Settings</p> <p>Admin Password: <input type="text"/></p> <p>Security Question1: <input type="text" value="What's your father's name?"/></p> <p>Answer1: <input type="text"/></p> <p>Security Question2: <input type="text" value="What's your father's name?"/></p> <p>Answer2: <input type="text"/></p> <p>Security Question3: <input type="text" value="What's your father's name?"/></p> <p>Answer3: <input type="text"/></p> <p style="text-align: center; margin-top: 10px;"><input type="button" value="Save"/></p> </div> <p>There are twelve default questions below, you can also customize the security questions.</p>

	
Account Management	<p>Click “Add” button, it will display Account Management page. You can add an account to the camera by entering Admin Password, User Level, User Name, New Password, Confirm, and edit user privilege by clicking <input type="checkbox"/>. The added account will be displayed in the account list.</p> <p>Admin Password: You can add an account only after you enter the correct admin password.</p> <p>User Level: Set the privilege for the account.</p> <p>User Name: Input user name for creating an account.</p> <p>Password: Input password for the account.</p> <p>Confirm: Confirm the password.</p> <p>You can edit and delete the account in the account list under the admin account. For the default admin account, you can only change the password, and it cannot be deleted.</p>

Note:

- 1) You can only add 20 users.
- 2) The operator privilege is all checked by default.
- 3) For camera firmware version 4X.7.0.69 or above, it removes the default admin password and allows to set a password when logging in for the first time. It also supports set-up of the security questions for the devices. Users can reset the password by answering the correct security questions in case of forgetting the password, which is more convenient for users.

Access List

General Settings

Maximum Number of Concurrent Streaming:

IP Access List

Rule:

IP Address:

Enable Access List Filtering:

Filter Type: Allow Deny

Table 4-5-10 Description of the buttons

Parameters	Function Introduction
General Settings	Maximum number of concurrent streaming: Select the maximum number of concurrent streaming. Options include No Limit, 1~9
IP access list	Rule: Single, Network and Range are available IP address: Input the address to get the access to the device
Enable access list filtering	Able to access or restrict access for some IP address
Filter type	Access or restrict access

Security Service

SSH Settings

Enable SSH:

SSH Port:

Table 4-5-11 Description of the buttons

Parameters	Function Introduction
------------	-----------------------

SSH Settings

Secure Shell (SSH) has many functions: it can replace Telnet and also provides a secure channel for FTP, POP, even for PPP.

Watermark

Watermark Settings

Enable Watermark:

Watermark String:

Save

Watermarking is an effective method to protect information security, realizing anti-counterfeiting traceability and copyright protection. Milesight Network Camera supports Watermark function to ensure information security.

About

Open Source Software Licenses

[View Licenses](#)

User can view some open source software licenses about the camera by clicking the View Licenses button.

4.5.4 SIP

The Session Initiation Protocol(SIP) is a signaling communications protocol, widely used for controlling multimedia communication sessions such as voice and video calls over Internet Protocol(IP) networks. This page allows user to configure SIP related parameters. Milesight cameras can be configured as SIP endpoint to call out when alarm triggered; or allow permitted number to call in to check the video if the video IP phone is used. To use this function, the settings in SIP page must be configured properly. There are two ways to get video through SIP, one is to dial the IP address directly, the other is account registration mode, the details are as follows:

Method 1: IP Direct mode

Dial on the camera's IP address directly through SIP phone, so you can see the video.

(**Note: SIP phone and the camera should in the same network segment**).

Method2: Account registration mode

- 1) Before using the SIP, you need to register an account for the camera from the SIP server;
- 2) Register another user account for the SIP device from the same SIP server;
- 3) Call the camera User ID from the SIP device, you will get the video on the SIP device.

SIP Settings

Unregistered	
Enable:	<input type="checkbox"/>
Register Mode:	Enable ▾
User ID:	500
User Name:	sipclient
Password:	*****
Server Address:	192.168.5.101
Server Port:	5060
Connection Protocol:	UDP ▾
Video Stream:	Secondary Stream ▾
Max Call Duration:	1800 s (0 means no limitation.)

Note:SIP supports Direct IP call.

Save

Table 4-5-12 Description of the buttons

Parameters	Function Introduction
Unregistered/ Registered	SIP registration status. Display “Unregistered” or “Registered”
Enable	Start or stop using SIP
Register Mode	Choose to use Enable mode or Disable mode. Enable mode means to use SIP with register account. Disable mode refers to use SIP without register account, just use the IP address to call.
User ID	SIP ID
User Name	SIP account name
Password	SIP account password
Server Address	Server IP address
Server Port	Server port
Connection Protocol	UDP/TCP
Video Stream	Choose the video stream
Max Call Duration	The max call duration when use SIP

Note: SIP supports Directly IP call.

Alarm Phone List

Phone Type:	Phone Number
To Phone Number:	<input type="text"/>
Remark Name:	<input type="text"/>
Duration:	From 00 : 00 To 24 : 00

Add

Table 4-5-13 Description of the buttons

Parameters	Function Introduction
Phone Type	Phone Number(Call by phone number) & Direct IP Call(Check to accept peer to peer IP call).
To Phone Number/ IP Address	Call by phone number or IP address.
Remark Name	Display name.
Duration	The time schedule to use SIP.

White List

Phone Type:	Phone Number
Phone Number:	<input type="text"/>

Add

Enable White List Number Filter:	<input type="checkbox"/>
----------------------------------	--------------------------

Save

Table 4-5-14 Description of the buttons

Parameters	Function Introduction
Phone Type	Phone Number(Call by phone number) & Direct IP Call
Phone Number/ IP Address	Including the phone number or IP address on the white list
Enable White List Number Filter	When enabled, only the designated phone number or IP address can visit

4.5.5 VCA

Smart Event uses Milesight Video Content Analysis technology. This technical capability is used in a

wide range of domains including entertainment, health-care, retail, automotive, transport, home automation, safety and security. Milesight VCA provides advanced, accurate smart video analysis for Milesight network cameras. It enhances the performance of network cameras through 10 detection modes which are divided into basic function and advanced function, enabling a comprehensive surveillance system and quicker response of cameras to different monitoring scenes.

Region Entrance

Region entrance helps to protect a special area from potential threat of suspicious person's or object's entrance. An alarm will be triggered when objects enter the selected regions by enabling region entrance.

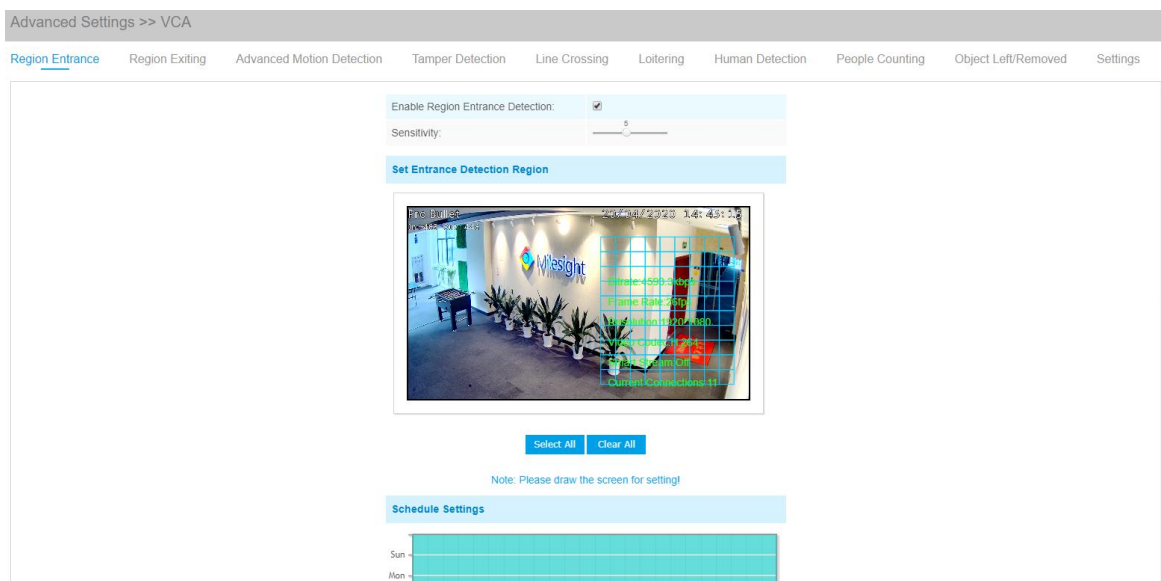

- Step1: Set detecting sensitivity;
- Step2: Set entrance detection region;
- Step3: Set detection schedule;
- Step4: Set alarm action;
- Step5: Set alarm settings. If you enable External Output and choose Constant External Output Action Time, when objects enter the selected regions, External Output Action alarm time will be always constant till the alarm is released.

Alarm Setting	
Record Video Sections:	5 seconds
Snapshot:	3
Snapshot Interval:	1 second
External Output Action Time:	<div style="border: 1px solid black; padding: 5px;"> <p>Customize</p> <p>10 seconds</p> <p>30 seconds</p> <p>1 minute</p> <p>5 minutes</p> <p>10 minutes</p> <p>Constant</p> </div>
Audio Action Settings:	

Region Exiting

Region exiting is to make sure that any person or object won't exit the area that is being monitored. Any exit of people or objects will trigger an alarm.

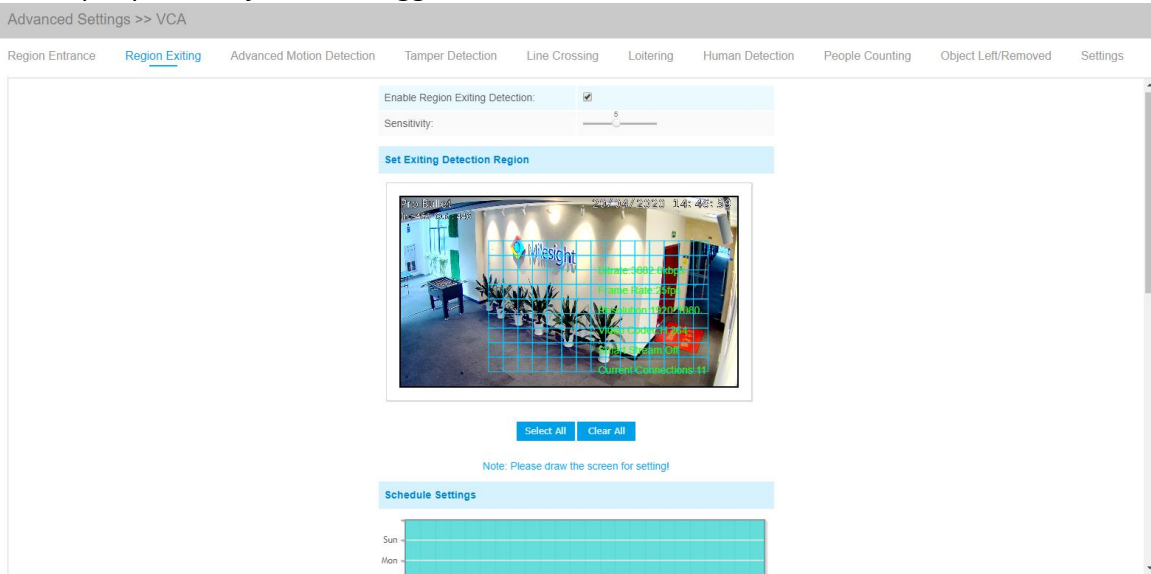

Step1: Set detecting sensitivity;

Step2: Set exiting detection region;

Step3: Set detection schedule;

Step4: Set alarm action;

Step5: Set alarm settings. If you enable External Output and choose Constant External Output Action Time, when objects exit the selected regions, External Output Action alarm time will be always constant till the alarm is released.

Alarm Setting	
Record Video Sections:	5 seconds
Snapshot:	3
Snapshot Interval:	1 second
External Output Action Time:	<div style="border: 1px solid black; padding: 5px;"> <p>Customize</p> <p>10 seconds</p> <p>30 seconds</p> <p>1 minute</p> <p>5 minutes</p> <p>10 minutes</p> <p>Constant</p> </div>
Audio Action Settings:	

Advanced Motion Detection

Different from traditional motion detection, Milesight advanced motion detection can filter out “noise” such as lighting changes, natural tree movements, etc. When an object moves in the selected area, it will trigger alarm.

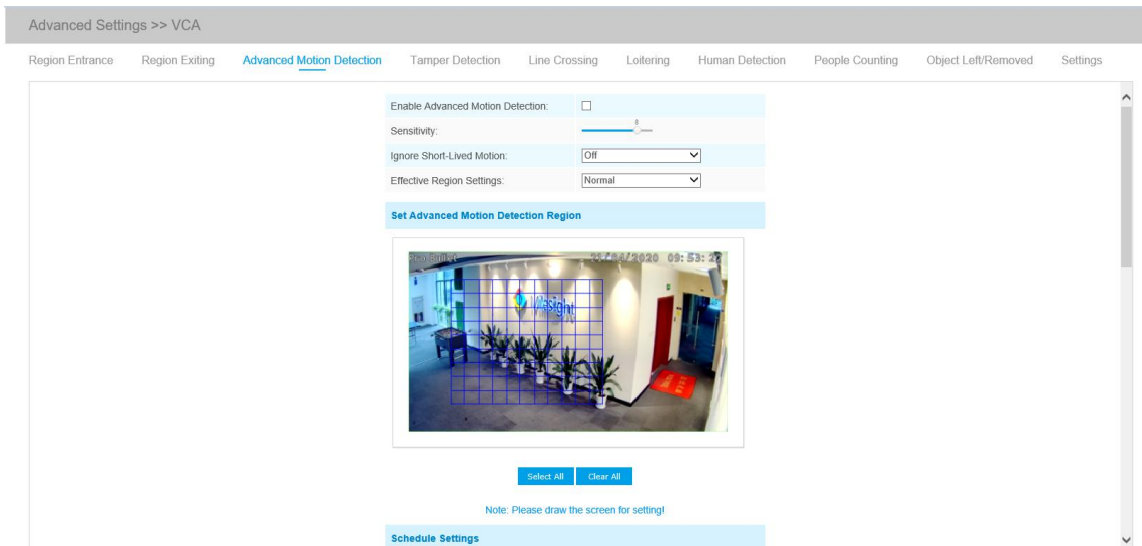

Step1: Set detecting sensitivity;

Step2: Set Ignore Short-Lived Motion time. If you set the time, when the moving duration of an object is within the setting time, it will not trigger alarm;

Step3: Set advanced motion detection region;

Step4: Set detection schedule;

Step5: Set alarm action;

Step6: Set alarm settings. If you enable External Output and choose Constant External Output Action Time, when object motion time is longer than the Ignore Short-Lived Motion time which you set in the selected regions, External Output Action alarm time will be always constant till the alarm is released.

Alarm Setting	
Record Video Sections:	5 seconds
Snapshot:	3
Snapshot Interval:	1 second
External Output Action Time:	<div style="border: 1px solid black; padding: 5px;"> Customize 10 seconds 30 seconds 1 minute 5 minutes 10 minutes Constant </div>
Audio Action Settings:	

Note:

- 1) The sensitivity can be configured to detect various movement according to different requirements. When the level of sensitivity is low, slight movement won't trigger the alarm.
- 2) Ignore Short-Lived Motion time is to avoid false alarm caused by instant object movement within time setting.

Tamper Detection

Tamper Detection is used to detect possible tampering like the camera being unfocused, obstructed or moved. This functionality alerts security staff immediately when any

above-mentioned actions occur.

Advanced Settings >> VCA

Region Entrance Region Exiting Advanced Motion Detection **Tamper Detection** Line Crossing Loitering Human Detection People Counting Object Left/Removed Settings

Enable Tamper Detection:

Sensitivity:

Schedule Settings

Sun
Mon
Tue
Wed
Thu
Fri
Sat

00 01 02 03 04 05 06 07 08 09 10 11 12 13 14 15 16 17 18 19 20 21 22 23 24

Edit

Alarm Action

Save Info Storage: File Format: Record (Please mount storage device.)

Upload Via FTP: File Format: Record

Upload Via Email: File Format: Snapshot

External Output: (Please configure the External Output)

Step1: Set detecting sensitivity;

Step2: Set detection schedule;

Step3: Set alarm action;

Step4: Set alarm settings. If you enable External Output and choose Constant External Output Action Time, when possible tampering is detected, External Output Action alarm time will be always constant till the alarm is released.

Alarm Setting

Record Video Sections: 5 seconds

Snapshot: 3

Snapshot Interval: 1 second

External Output Action Time: **Customize**
10 seconds
30 seconds
1 minute
5 minutes
10 minutes
Constant

Audio Action Settings:

Note:

The algorithm supports defocus detection in Tamper Detection function.

Line Crossing

Line Crossing detection is designed to work in most indoor and outdoor environment. An event will be triggered every time when the camera detects objects crossing a defined virtual line.

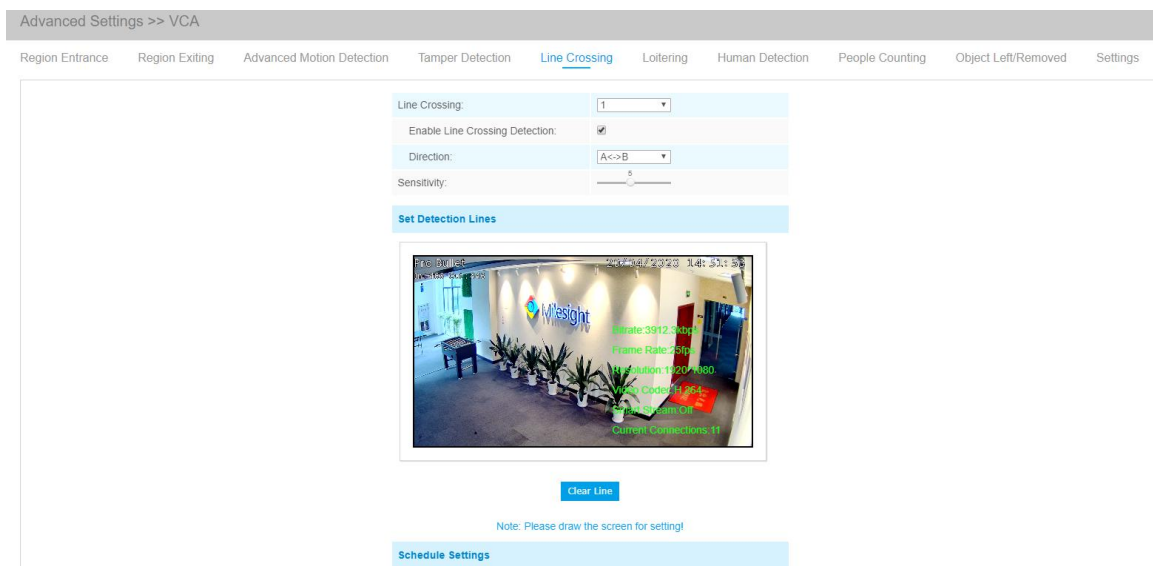

Settings steps are shown as follows:

Step1: Choose a line number;

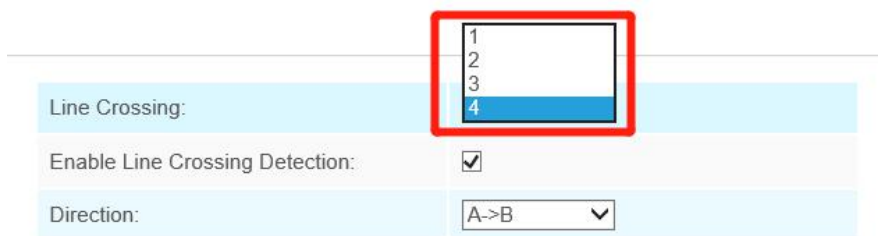

Step2: Enable Line Crossing Detection and define its direction;

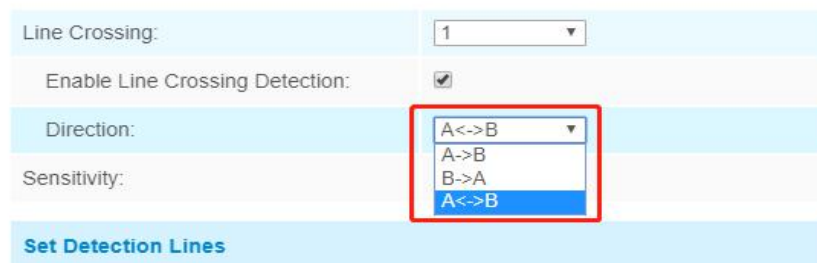

Step3: Set detecting sensitivity;

Step4: Draw detection lines;

Step5: Set detection schedule;

Step6: Set alarm action;

Step7: Set alarm settings. If you enable External Output and choose Constant External Output Action Time, when objects cross a defined virtual line, External Output Action alarm time will be always constant till the alarm is released.

Alarm Setting	
Record Video Sections:	5 seconds
Snapshot:	3
Snapshot Interval:	1 second
External Output Action Time:	<div style="border: 1px solid black; padding: 5px;"> Customize 10 seconds 30 seconds 1 minute 5 minutes 10 minutes Constant </div>
Audio Action Settings:	

Note:

Milesight allows to set up to four lines at a time. There are three direction modes to choose for triggering alarm. "A→B" means when there is any object crossing the line from the "A" side to the "B" side, the alarm will be triggered. "B→A" vice versa. "A ↔ B" means that the alarm will be triggered when objects cross line from either side.

Loitering

When objects are loitering in a defined area for a specific period of time, it would trigger an alarm.

Advanced Settings >> VCA

Region Entrance Region Exiting Advanced Motion Detection Tamper Detection Line Crossing **Loitering** Human Detection People Counting Object Left/Removed Settings

Enable Loitering Detection:

Min. Loitering Time: (3-1800) s

Set Loitering Detection Region



09:57:53

Select All Clear All

Note: Please draw the screen for setting!

Schedule Settings

Sun

Step1: Set minimum loitering time;

Step2: Set loitering detection region;

Step3: Set detection schedule;

Step4: Set alarm action;

Step5: Set alarm settings. If you enable External Output and choose Constant External Output Action Time, when objects loiter in the selected regions, External Output Action alarm time will be always constant till the alarm is released.

Alarm Setting	
Record Video Sections:	5 seconds
Snapshot:	3
Snapshot Interval:	1 second
External Output Action Time:	<div style="border: 1px solid black; padding: 5px;"> Customize 10 seconds 30 seconds 1 minute 5 minutes 10 minutes Constant </div>
Audio Action Settings:	

Note:

After setting minimum loitering time from 3s to 1800s, any objects loitering in the selected area over the minimum loitering time will trigger the alarm.

Human Detection

Human detection is used for figuring out whether an object is a human or not. Once human detection is enabled, when there is an object appearing in the detecting area, an ID will show on the frame. If the object is a person, it will mark as “person”. When the Show Tracks is enabled, the tracks of the moving object will show on the screen.

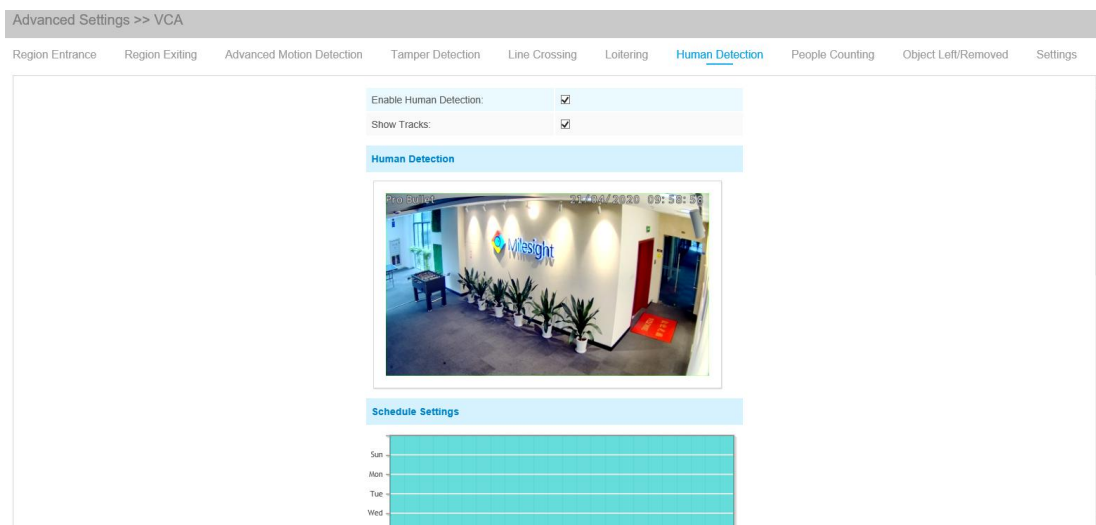

Step1: Enable Human Detection;

Step2: Check Show Tracks;

Step3: Set schedule settings;

Step4: Set alarm action.

Step5: Set alarm settings. If you enable External Output and choose Constant External Output Action Time, when detected object is marked as “person”, External Output Action alarm time will be always constant till the alarm is released.

Alarm Setting	
Record Video Sections:	5 seconds
Snapshot:	3
Snapshot Interval:	1 second
External Output Action Time:	<div style="border: 1px solid black; padding: 5px;"> Customize 10 seconds 30 seconds 1 minute 5 minutes 10 minutes Constant </div>
Audio Action Settings:	

People Counting

People counting is able to count that how many people enter or exit during the setting period.

Advanced Settings >> VCA

Region Entrance Region Exiting Advanced Motion Detection Tamper Detection Line Crossing Loitering Human Detection **People Counting** Object Left/Removed Settings

Enable People Counting:

Set Detection Line

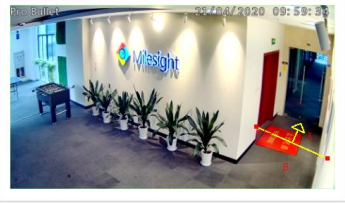

Note: Please draw the screen for setting!

Schedule Settings

Sun	
Mon	

- Step1: Set detection line;
- Step2: Set detection schedule;
- Step3: Set counting OSD;

Counting OSD	
Show Video Title:	<input checked="" type="checkbox"/>
Font Size:	Small
Font Color:	
Text Position:	Top-Left

The OSD of the people counting support automatic zeroing;

Enable Auto Reset:	<input checked="" type="checkbox"/>
Day:	Everyday
Time:	00:00:00

Step4: Click “Edit” to check the counting logs, the data log can be exported to FTP/ SMTP/ Storage automatically as an Excel spreadsheet according to the time interval and range you set;

Log Settings	
Logs:	Edit
Enable Auto Export Logs:	<input checked="" type="checkbox"/>
Day:	Everyday
Time:	00:00:00
Export Time Range::	All
Export to:	<input type="checkbox"/> FTP <input type="checkbox"/> SMTP <input type="checkbox"/> Storage

Step5: Set alarm trigger. Alarm will be triggered when the thresholds reaches to a certain value from 1 to 9999.

Alarm Trigger	
Enable Alarm	<input checked="" type="checkbox"/>
Thresholds:	<input type="checkbox"/> In: <input type="text" value="9999"/> <input type="checkbox"/> Out: <input type="text" value="9999"/> <input type="checkbox"/> Capacity: <input type="text" value="9999"/> <input type="checkbox"/> Sum: <input type="text" value="9999"/>

Step6: Set alarm action;

Step7: Set alarm settings. If you enable External Output and choose Constant External Output Action Time, when the thresholds reach to a certain value you set, External Output Action alarm time will be always constant till the alarm is released.

Alarm Setting	
Record Video Sections:	5 seconds
Snapshot:	3
Snapshot Interval:	1 second
External Output Action Time:	<div style="border: 1px solid black; padding: 5px;"> Customize 10 seconds 30 seconds 1 minute 5 minutes 10 minutes Constant </div>
Audio Action Settings:	

Note:

Crossing along the direction of the arrow will record as "In", opposite is "Out";

Object Left/Removed

Object Left can detect and prompt an alarm if an object is left in a pre-defined region. Object Removed can detect and prompt an alarm if an object is removed from a pre-defined region.

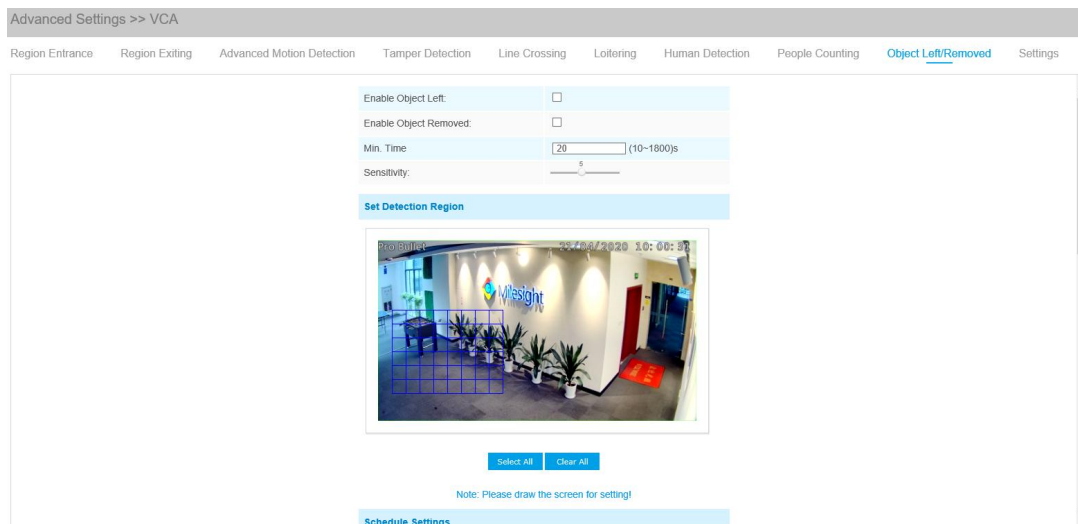

- Step1: Enable Object Left or Object Removed(Or you can enable both features at the same time);
- Step2: Set minimum time;
- Step3: Set detecting sensitivity;
- Step4: Set detection region;
- Step5: Set detection schedule;
- Step6: Set alarm action;
- Step7: Set alarm settings. If you enable External Output and choose Constant External Output Action Time, when an object is left/removed from the selected regions, External Output Action alarm time will be always constant till the alarm is released.

Alarm Setting	
Record Video Sections:	5 seconds
Snapshot:	3
Snapshot Interval:	1 second
External Output Action Time:	<div style="border: 1px solid black; padding: 5px;"> <p>Customize</p> <p>10 seconds</p> <p>30 seconds</p> <p>1 minute</p> <p>5 minutes</p> <p>10 minutes</p> <p>Constant</p> </div>
Audio Action Settings:	

Note:

1. After setting minimum time from 3s to 1800s, any objects are left in the selected area or removed from the selected area over the minimum time will trigger the alarm.
2. Object Left/Removed is optional, if you need this function, please contact Milesight sales first.

Settings

Milesight VCA provides the primary setting for the whole VCA functions. “Minimum Size” is to set the whether an object is big enough to trigger other settings. The frame you draw on the screen means that only if the object size is bigger than the frame, the settings for other VCA functions will take effect. Maximum Size means opposite, the frame you draw on the screen stands for that only if the object size is smaller than the frame, the settings for other VCA functions will take effect.

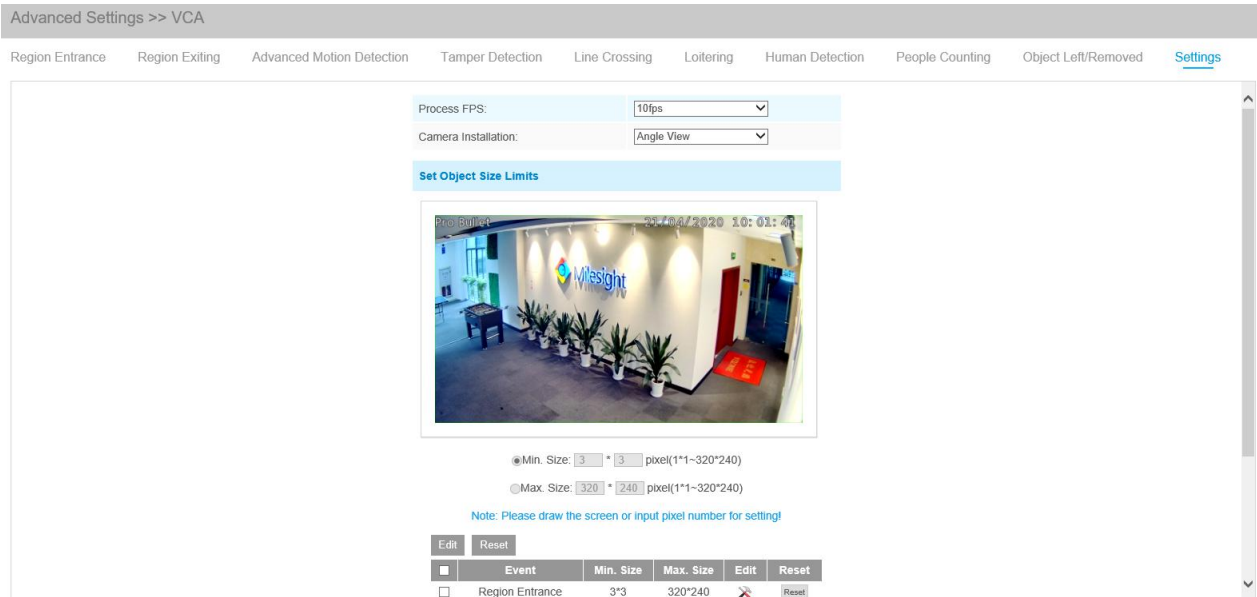
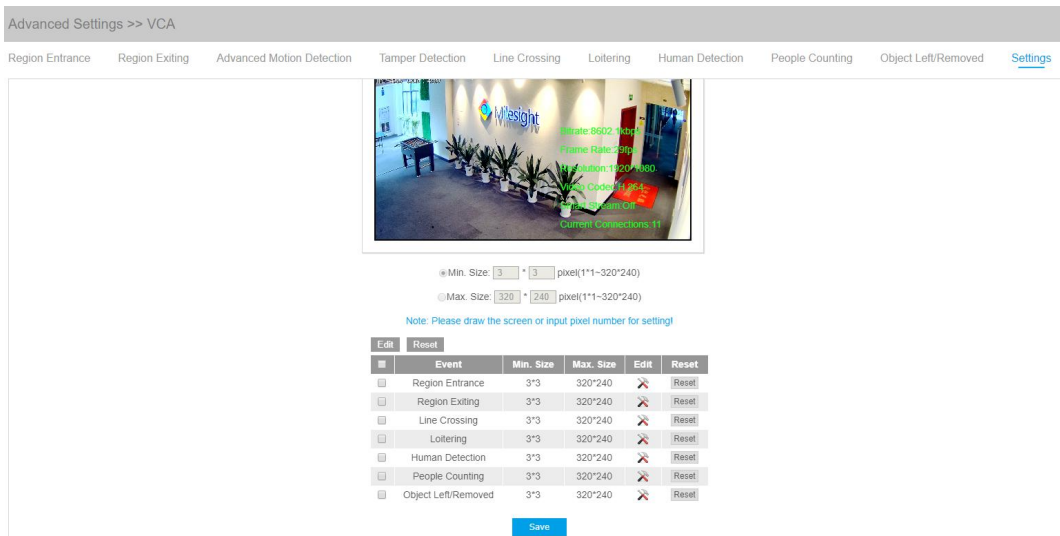

Table 4-5-15 Description of the buttons

Parameters	Function Introduction
Process FPS	Five different periods are available(5, 10, 15, 20, 25, fps) for process fps
Camera Installation	Select camera installation view, including Angle View , Horizontal View and Overhead View
Minimum Size	Draw the screen or input pixel number to set the minimum size of the detected object. When the object is smaller than this size, it will not be detected. The default minimum size is 1*1.
Maximum Size	Draw the screen or input pixel number to set the maximum size of the detected object. When the object is larger than this size, it will not be detected. The default maximum size is 320*240.

Note:

VCA function supports setting the Min.Size and Max.Size of the detection object separately.



4.5.6 Face Detection(Optional)

The face detection function can detect the face appearing in the drawn area and support to upload the face screenshot to NAS, FTP, SMTP, HTTP Notification, etc.

Face Detection is **optional for Motorized Pro Dome, ABF Pro Box and Motorized Pro Bullet Network Camera.**

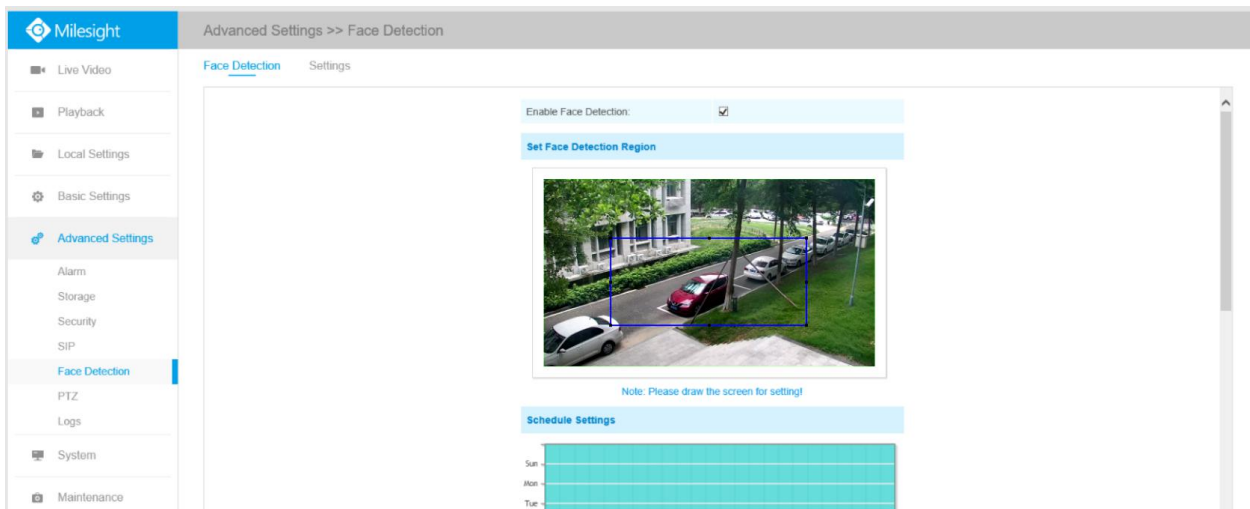

- Step1: Enable Face Detection;
- Step2: Set a rectangular face detection region, you can drag the detection region to adjust the size of the region. Only faces in this region will be detected;
- Step3: Set detection schedule;
- Step4: Set Face Capture Configuration;

Face Capture Configuration	
Capture Mode:	Quality Priority
Snapshot Type:	Face Only <input checked="" type="checkbox"/> Background
Snapshot:	1
Record Video Sections:	5 seconds
Pre-record:	0 second
Save Into NAS:	<input type="checkbox"/> File Format: AVI (Please mount NAS.)
Upload Via FTP:	<input type="checkbox"/> File Format: JPG
Upload Via SMTP:	<input type="checkbox"/> File Format: JPG
HTTP Notification:	<input type="checkbox"/>

Table 4-5-16 Description of the buttons

Parameters	Function Introduction
Capture Mode	<p>Auto Mode, Quality Priority, Timeliness Priority, Customize are available.</p> <p>Auto Mode: In this mode, it will push a face screenshot based on screenshot quality and push speed when the face is detected.</p> <p>Quality Priority: In this mode, it will push a face screenshot of best quality when</p>

	<p>the face is detected.</p> <p>Timeliness Priority: In this mode, it will push a face screenshot in the shortest time when the face is detected.</p> <p>Customize: In this mode, you can customize some detect conditions, including Snapshot Interval, Oblique Face Angle Limit, Pitching Face Angle Limit, Side Face Angle Limit, Blur Limit.</p>
Snapshot Interval	<p>80 milliseconds, 200 milliseconds, 500 milliseconds, 1 second, 2 seconds and 4 seconds are available.</p> <p>Note: this option is optional for Auto mode and Customize mode.</p>
Oblique Face Angle Limit	<p>Set Oblique Face Angle Limit to 1~180. The larger the value, the larger angle the oblique face that can be detected.</p> <p>Note: this option is optional for Customize mode.</p>
Pitching Face Angle Limit	<p>Set Pitching Face Angle Limit to 1~180. The larger the value, the larger angle the pitching face that can be detected.</p> <p>Note: this option is optional for Customize mode.</p>
Side Face Angle Limit	<p>Set Side Face Angle Limit to 1~180. The larger the value, the larger angle the side face that can be detected.</p> <p>Note: this option is optional for Customize mode.</p>
Blur Limit	<p>Set Blur Limit to 1~10. The larger the value, the more blurred the face can be detected.</p> <p>Note: this option is optional for Customize mode.</p>
Snapshot Type	<p>Face Only, Upper Body, Whole Body are available.</p> <p>Face Only: Capture the screenshot of face only.</p> <p>Upper Body: Capture the screenshot of upper body.</p> <p>Whole Body: Capture the screenshot of whole body.</p> <p>If you check the "Background" option, it will take another screenshot of the entire image.</p>
Snapshot	<p>Set the number of screenshot to 1~5. It will take screenshot based on the snapshot interval you set.</p>
Record Video Sections	<p>Six different periods are available(5, 10, 15, 20, 25, 30 sec).</p>
Pre-record	<p>Reserve the record time before alarm, 0~10 sec.</p>
Save Into NAS	<p>Save the alarm files into NAS.</p>
Upload Via FTP	<p>Upload the alarm files via FTP.</p>
Upload Via SMTP	<p>Upload the alarm files via SMTP.</p>
HTTP Notification	<p>Support to pop up the alarm news to specified HTTP URL.</p>

Step5: Set minimum size of object on setting page. The default minimum size is 50.

You can also check the checkbox to enable Face Detection Message Post.

It will push information to some third-party devices or softwares that are compatible with ours. Inf

ormation can be pushed by TCP.

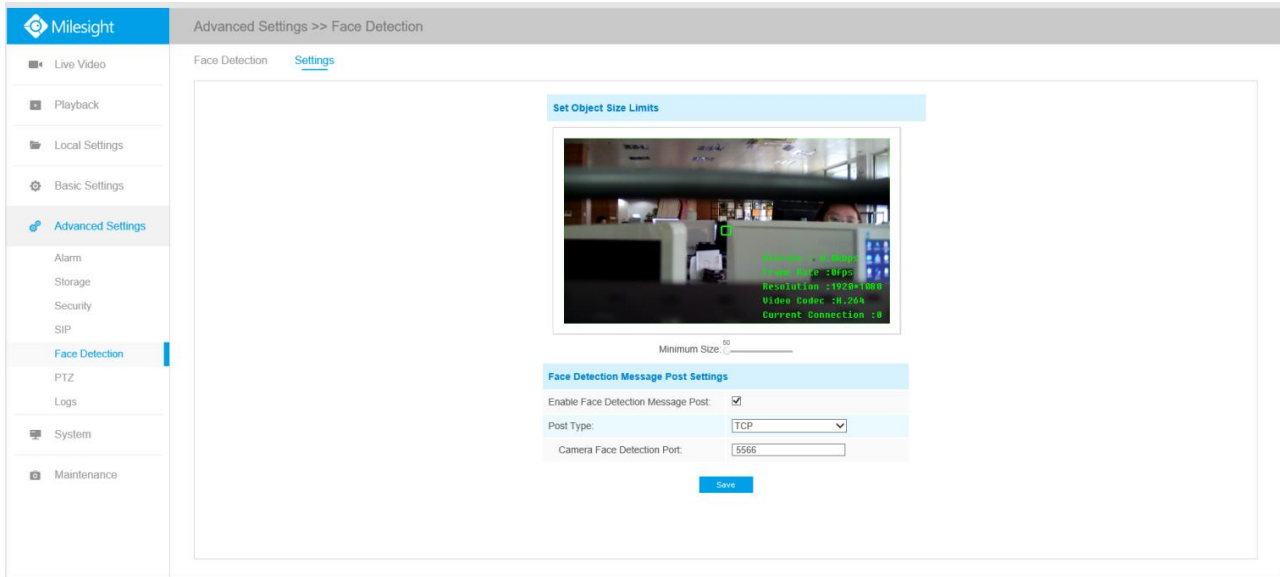

Step6: It will detect the face in the live view according to the region and conditions you set. If you check the "Show Tracks" option, it will display the face screenshot with the ID on the left side of the live view.

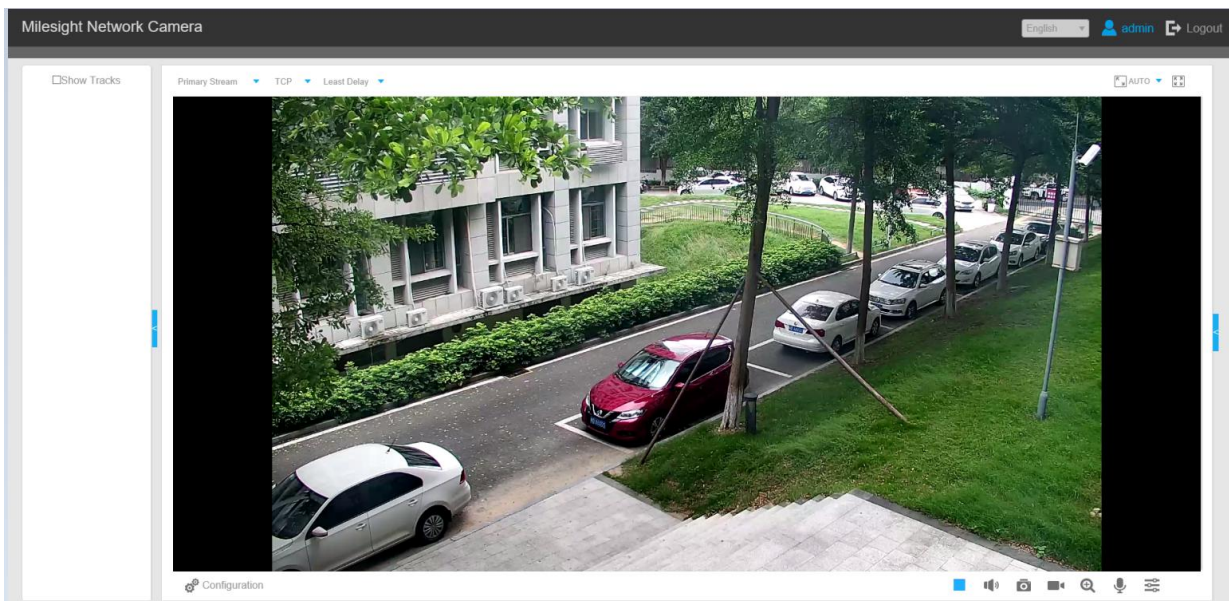

4.5.7 Heat Map(Optional)

Heat Map function can analyze customers movement to reveal insights for better business management with the intuitive and accurate statistical analysis results in time or space pattern as needed.

Note:

- (1) Currently Heat Map is only supported in the original view of 360° Panoramic Fisheye Network Camera and the dewarping view of 180° Panoramic Mini Bullet Network Camera and 180° Panoramic Mini Dome Network Camera.
- (2) Please upgrade the camera to V43.7.0.75 or above to use Heat Map function.

(3) Only allowed to view reports within 7 days without a SD card or NAS.

Heat Map

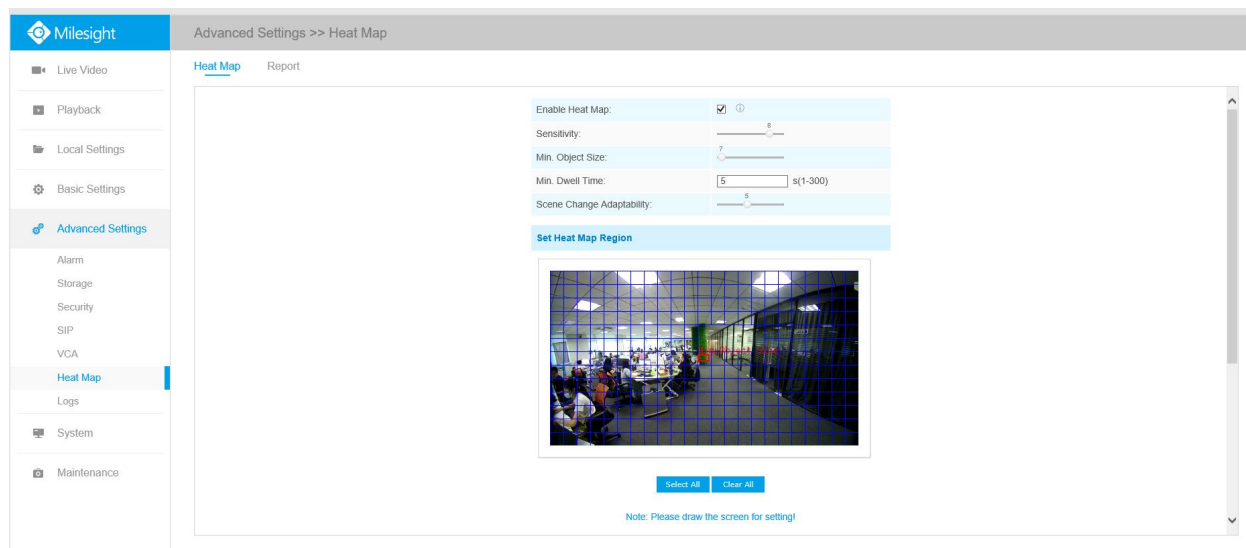

Step 1: After log in the web, go to **“Advanced Settings”**→ **“Heat Map”**. Check the checkbox **“Enable Heat Map”**, then set the Heat Map settings as shown below.

Table 4-5-17 Description of the buttons

Parameters	Function Introduction
Sensitivity	Level 1~10 are available, the default level is 5. The higher the sensitivity, the easier it is for moving objects to be recorded in the results.
Min. Object Size	Set the minimum object size from 1 to 100, the default value is 10. Objects smaller than this value will not be recorded in the result.
Min. Dwell Time	Set the minimum dwell time from 1 to 300, the default value is 30. If the object stays in the area longer than the set "Minimum Dwell Time", it will not be recorded in the result.
Scene Change Adaptability	Level 1~10 are available, the default level is 5. Scene Change Adaptability indicates the camera's adaptability to scene changes, which can increase the accuracy of detection. The camera better adapts to faster changing scenes if the value is higher.

Step 2: Set Heat Map Region. Draw the screen to set the detection area. You can click **“Select All”** button to select all areas, or **“Clear All”** button to remove the current drawn area.

Set Heat Map Region

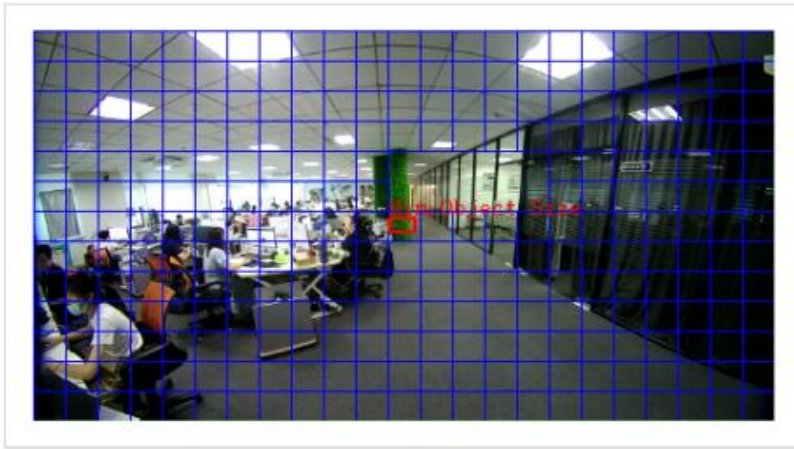

Select All Clear All

Note: Please draw the screen for setting!

Step 3: Schedule Settings. You can draw the schedule by clicking **“Edit”** button. And then click **“Save”** or **“Reset”** after finishing setting.

Schedule Settings

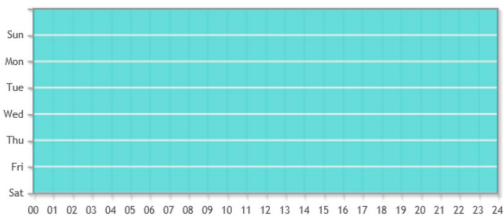

Edit

Milesight Network Camera										
Time Schedule										
	Period1			Period2			Period3			
<input checked="" type="checkbox"/> Sunday	00	00	-24	00	00	-00	00	00	-00	Copy to Other Days
<input checked="" type="checkbox"/> Monday	00	00	-24	00	00	-00	00	00	-00	Copy to Other Days
<input checked="" type="checkbox"/> Tuesday	00	00	-24	00	00	-00	00	00	-00	Copy to Other Days
<input checked="" type="checkbox"/> Wednesday	00	00	-24	00	00	-00	00	00	-00	Copy to Other Days
<input checked="" type="checkbox"/> Thursday	00	00	-24	00	00	-00	00	00	-00	Copy to Other Days
<input checked="" type="checkbox"/> Friday	00	00	-24	00	00	-00	00	00	-00	Copy to Other Days
<input checked="" type="checkbox"/> Saturday	00	00	-24	00	00	-00	00	00	-00	Copy to Other Days

Save Reset

Report

The results will be displayed on **“Report”** interface.

Advanced Settings >> Heat Map

Heat Map [Report](#)

Space Heat Map

0 2hr, 38min, 57sec.

Heat Map Report Search

Main Type:

Report Type:

Start Time:

[Search](#)

[Report Export](#)

[Auto Export](#)

Step 1: Select Main Heat Map Type.

[Space Heat Map]: Space Heat Map will be presented as a picture with different color. Different colors represent different heat values. Red represents the highest and blue represents the lowest.

[Time Heat Map]: Time heat map will be presented as a line chart to show the heat at different times.

Step 2: Select Report Type including Daily Report, Weekly Report, Monthly Report and Annual Report.

Step 3: Select Start Time, then click the **“Search”** button, the camera will automatically count the data for the day/ week/ month/ year (based on the report type selected by the user) from the start time and generate the corresponding report as shown below.

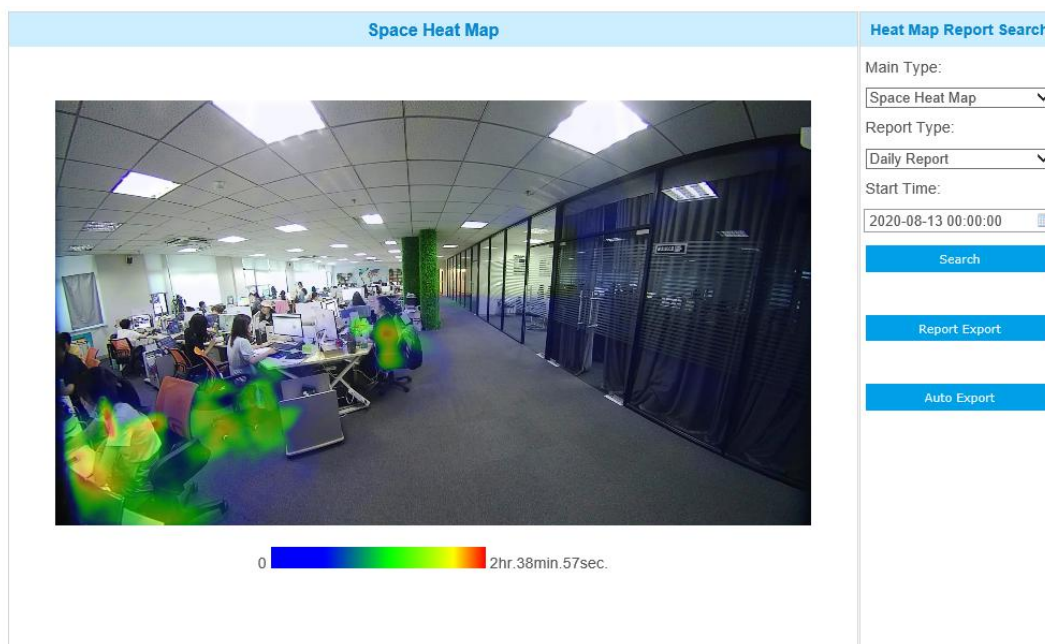

Space Heat Map

Step 4: Click the **"Report Export"** button to export the report to local.

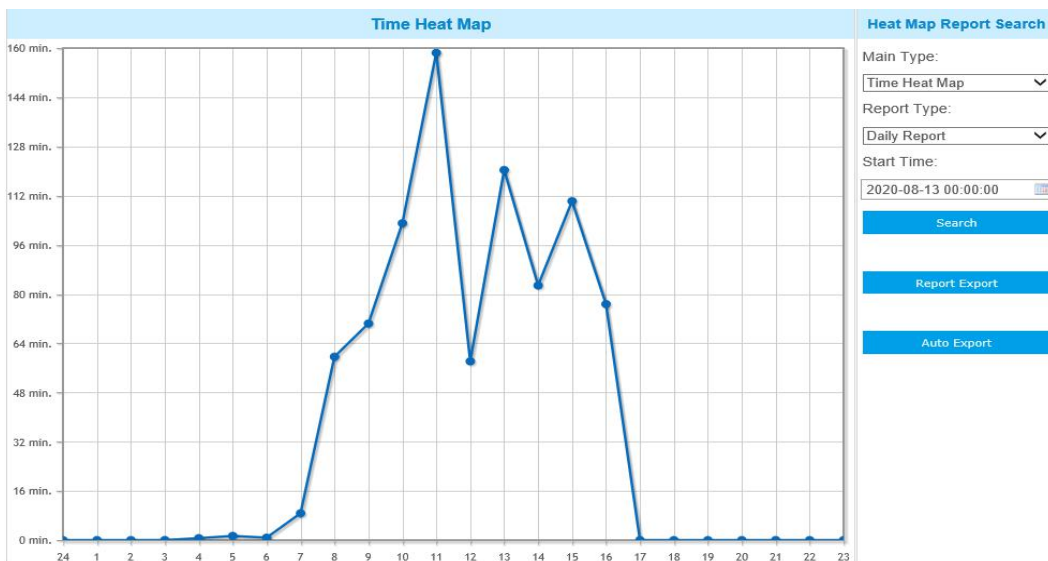

Time Heat Map

Step 5: Click the "Auto Export" button to pop up the Heat Map Report Settings as shown below.

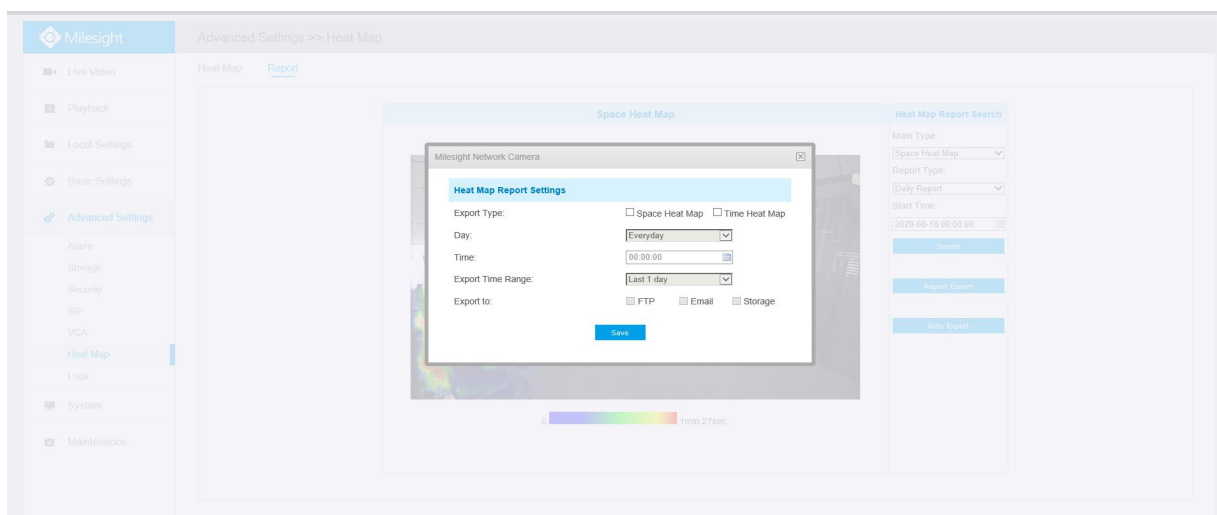

① Set Export Type. User can check Space Heat Map or Time Heat Map or both. When either Space Heat Map or Time Heat Map is checked, the gray item becomes editable as shown below;

② Set Day. User can choose Everyday to export daily reports, while choosing others to export reports on a specific day of the week;

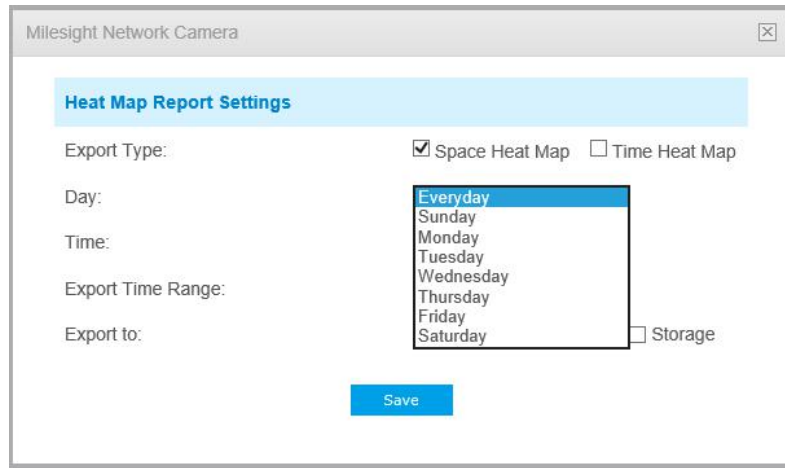

③ Set Time. User can choose the time of day to export the heat map automatically, click the calendar icon to pop up the following Quick Selection;

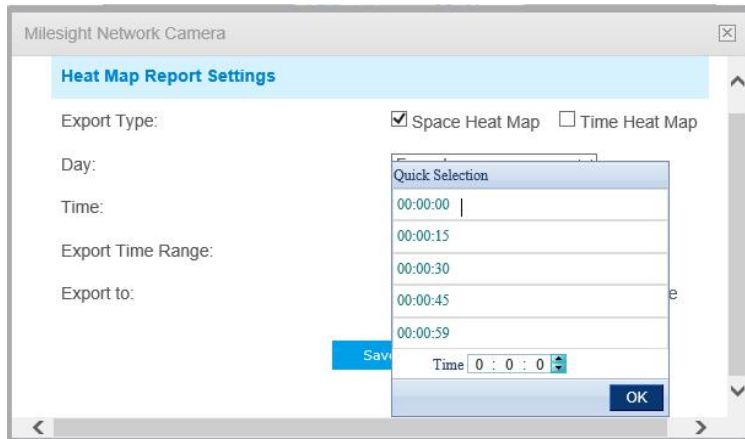

④ Set Export Time Range.

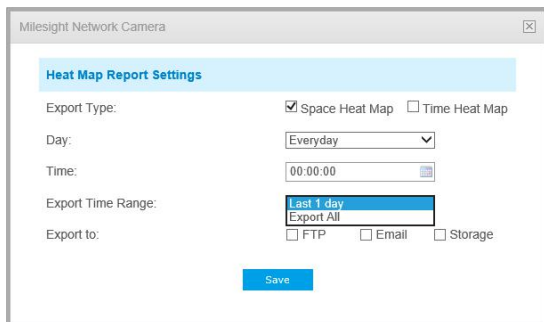

Day (Choose Everyday)

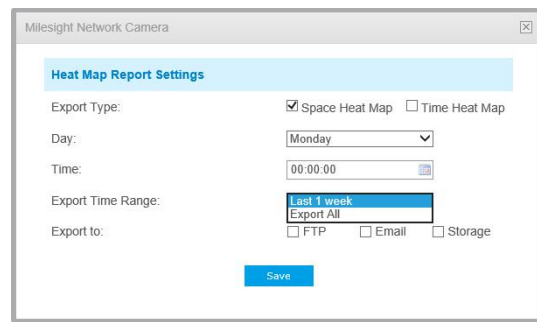

Day (Choose Week)

⑤ Set the destination path of the automatically exported report. The report can be exported to FTP/Email/Storage automatically as the form of an Excel spreadsheet or a picture according to the day, time and export time range you set. Then click "Save".

Milesight Network Camera ✕

Heat Map Report Settings

Export Type: Space Heat Map Time Heat Map

Day: Wednesday ▼

Time: 00:00:59 📅

Export Time Range: Last 1 week ▼

Export to: FTP Email Storage

Save

If the current Space Heat Map is generated, it will be saved as a png image. If the current Time Heat Map is generated, it will be saved as a csv form.

4.5.8 Logs

The logs contain the information about the time and IP that has accessed the camera through web.

Show 30 entries

Time	Main Type	Sub Type	Param	User	IP	Detail
2017-09-04 13:35:41	Operation	RTSP Session Stop	-	-	192.168.8.50	stop one session.
2017-09-04 13:29:18	Operation	RTSP Session Start	-	-	192.168.8.50	start one session.
2017-09-04 13:29:14	Operation	RTSP Session Stop	-	-	192.168.8.50	stop one session.
2017-09-04 13:28:54	Operation	RTSP Session Start	-	-	192.168.8.50	start one session.
2017-09-04 13:28:53	Operation	Login Remotely	-	admin	192.168.8.50	-
2017-09-04 05:50:00	Information	IR-CUT On	-	-	-	-
2017-09-03 18:35:25	Information	IR-CUT Off	-	-	-	-
2017-09-03 05:43:58	Information	IR-CUT On	-	-	-	-
2017-09-02 18:37:57	Information	IR-CUT Off	-	-	-	-
2017-09-02 05:41:22	Information	IR-CUT On	-	-	-	-
2017-09-01 18:43:37	Information	IR-CUT Off	-	-	-	-
2017-09-01 17:00:57	Operation	RTSP Session Stop	-	-	192.168.8.50	stop one session.
2017-09-01 16:55:24	Event	Motion Detection Stop	-	-	-	-
2017-09-01 16:55:19	Operation	RTSP Session Start	-	-	192.168.8.50	start one session.
2017-09-01 16:55:17	Operation	RTSP Session Stop	-	-	192.168.8.50	stop one session.

Log Search

Main Type: All Types ▼

Sub Type: All Types ▼

Start Time: 2017-09-04 00:00:00 📅

End Time: 2017-09-04 13:30:26 📅

Search

Log Export

Save Period: Permanent ▼

Save

Showing 1 to 30 of 1,221 entries First Previous 1 2 3 4 5 ... 41 Next Last Go

Table 4-5-18 Description of the buttons

Parameters	Function Introduction
Main Type	There are five main log types: All Type, Event, Operation, Information, Exception, Event
Sub Type	On the premise of main type has been selected, select the sub type to narrow the range of logs

Start Time	The time log starts
End Time	The time log ends
Log Export	Export the logs
Save Period	Set the period of log saving, there are eight options to choose: Permanent and 30/60/120/180/240/300/360 Days
Go	Input the number of logs' page



4.6 LPR(Optional)

4.6.1 Live Video

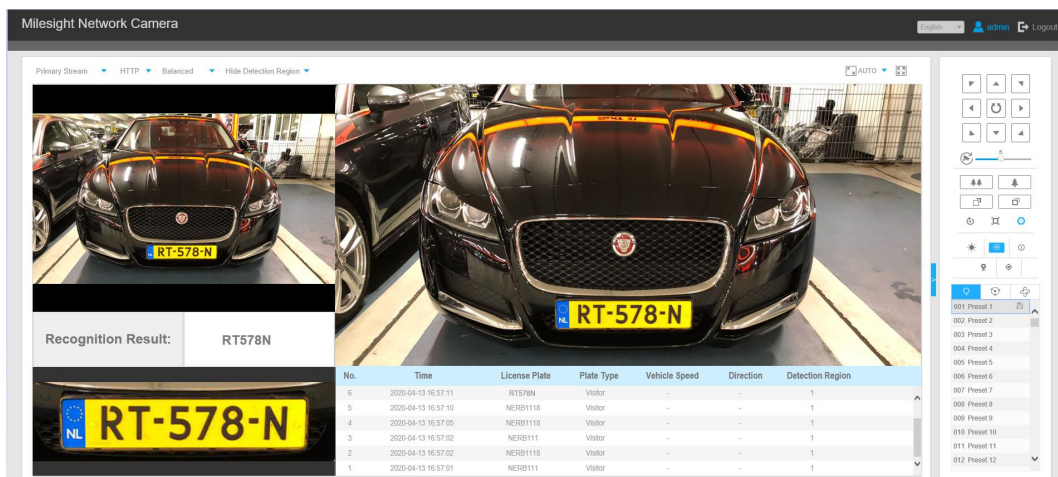
Milesight LPR Camera supports professional LPR Live View interface , it can show the real-time license plate recognition results and display the snapshots of detected license plates ,which realizes a stand-alone LPR solution.



Note:

For Snapshot/Recording ( / ), you can click to capture/record the current image/video ,but only when you using the IE browser with plugin, it will automatically be saved to the configured path on your PC and pop up the corresponding folder. If you using the Chrome/Firefox/Safari/Edge browser in Plugin-Free Mode, it will not automatically pop up the corresponding folder to show you the details.

4.6.2 Settings

The LPR function will automatically detect and capture license plate in real time and compares to a predefined list, then takes appropriate action such as generating an alert once the license plate is on the predefined black list.

Note:

(1) LPR is optional for 12X AF Motorized Pro Bullet, Mini PoE PTZ Bullet, ABF Pro Box, Vandal-proof Motorized Mini Bullet, Motorized Pro Bullet Network Camera, Mini Bullet Network Camera.

(2) Currently we have three LPR versions, **LPR1, LPR2 and LPR3**. LPR1 is for Asian regions, LPR2 is for European regions and the former Soviet Union and LPR3 is for Korea.

For more information, please refer to ***Milesight-Troubleshooting-LPR setting-LPR1, Milesight-Troubleshooting-LPR setting-LPR2, Milesight-Troubleshooting-LPR setting-Korea.***

General

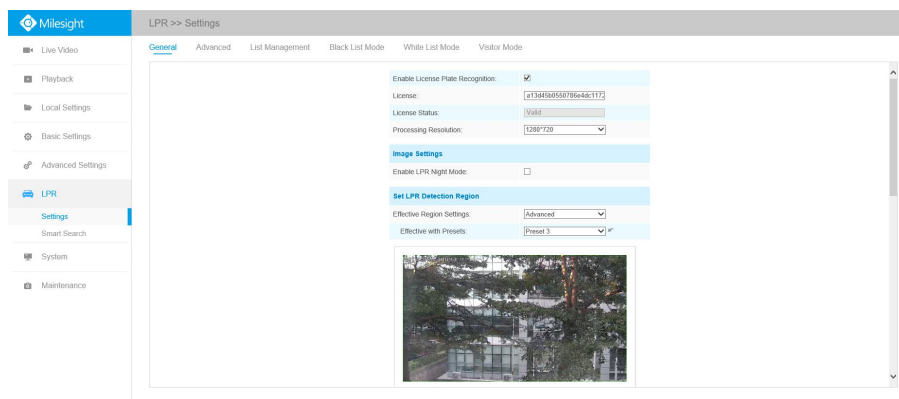

Step1: Enter the license and click Save. When the License Status changes to Valid, the camera can start detecting the license plates.

Enable License Plate Recognition:	<input checked="" type="checkbox"/>
License:	7325220EC7B6C181B38A
License Status:	Valid
Processing Resolution:	1280*720

Note: Only LPR2 and LPR3 need to enter a license to activate the LPR function.

Step2: The LPR Night Mode supports the optimal LPR night recognition effect by adjusting different parameter levels. You can choose Customize to set effective time manually, or choose Auto Mode which can automatically switch to night mode according to illumination intensity.

Image Settings	
Enable LPR Night Mode:	<input checked="" type="checkbox"/>
Effective Time:	Customize
Start Time:	18 00
End Time:	06 00
Level:	<input type="range" value="4"/>

Customize Mode

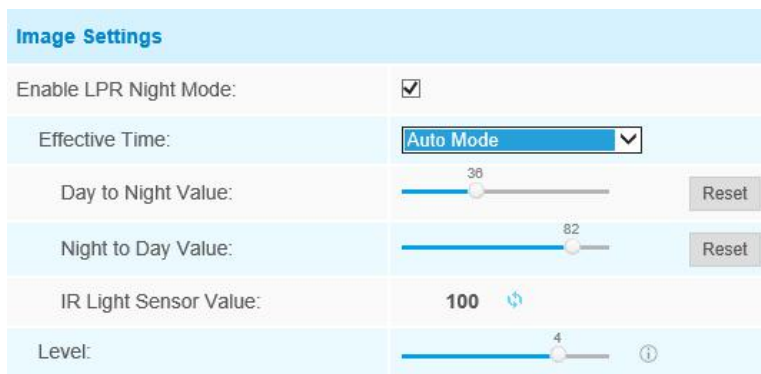

Auto Mode

Step3: Check the checkbox “Enable License Plate Recognition”, you can draw the screen to select area interested.

Table 4-6-1 Description of the buttons

Parameters	Function Introduction
License (Only for LPR2 and LPR3)	Generated by camera’s information
License Status (Only for LPR2 and LPR3)	Show present license status, including Valid and Invalid .
Processing Resolution	Resolution of the stream for LPR analysis, including 1920*1280, 1280*720, 640*360, 320*176.
Country/ Region (Only for LPR1)	Select country/ region to detect the license plate.
Effective Region Settings (Only for PTZ series)	Normal: configure the LPR detection regions for the current area. Advanced: configure different LPR detection regions for different PTZ presets(Only support Preset 1~4 so far).
Enable Day/Night Detection Mode (Only for LPR3)	With this option enabled, the camera will enable different detection modes according to Day/Night mode.
Enable Vehicle Speed Detection (Only for LPR3)	With this option enabled, the camera will detect the vehicle speed and display results on the Smart Search interface. You need to draw two lines(Line1 and Line2) on the live view, and fill in Camera Installation Height, Horizontal Distance1 and Horizontal Distance2, camera will combine the lines you draw and the data filled to calculate the vehicle speed. Camera Installation Height: real height of camera. Horizontal Distance1: real distance between camera pole and line1. Horizontal Distance2: real distance between camera pole and line2.

Speed of vehicle

- Requirement
 - ✓ Real height of camera (H) (unit: meter) →
 - ✓ Real distance between camera pole and line (d1, d2) (unit: meter) →
 - ✓ Pixel position of each line (y1, y2) (unit: pixel)

- To be changed UI
 - ✓ Drawable two lines
 - ✓ Edit boxes to input camera height and distance of each line

Add

Draw the screen to select the area interested, then click "Add" button to add the area, only four recognition areas can be added.

You can edit the name of the area or delete the area in the list below.

ID	Name	Edit	Delete
1	<input type="text" value="ROI_1"/>		
2	ROI_2		
3	ROI_3		
4	ROI_4		

Note:

Only license plates larger than 150 pixels can be recognized.

Clear

Click the "Clear" button to clear the area being drawn.

Delete All

Click the "Delete All" button to delete all the added areas.

Step4: Schedule Settings. You can draw the schedule by clicking Edit button.

Schedule Settings

Step5: Set Detection Settings and LPR Message Post Settings.

Detection Settings	
Detection Trigger:	Always <input type="button" value="v"/>
Confidence Level:	<input type="range" value="4"/>
Repeat Plate Checktime:	0 <input type="button" value="ms"/> (0-60000ms)
Features Identification:	<input type="checkbox"/> All <input type="checkbox"/> Direction <input type="checkbox"/> Detection Region <input type="checkbox"/> Region
LPR Message Post Settings	
Enable LPR Message Post:	<input checked="" type="checkbox"/>
Post Type:	HTTP <input type="button" value="v"/>
HTTP Method:	Post <input type="button" value="v"/>
Snapshot Type:	All <input type="button" value="v"/>
HTTP Notification URL:	<input type="text"/>
User Name:	<input type="text"/>
Password:	<input type="text"/>

Table 4-6-2 Description of the buttons

Parameters	Function Introduction
Detection Trigger	<p>Always: in this mode, camera will always detect license plates.</p> <p>Alarm Input: in this mode, camera will only detect license plates during Alarm Input is being triggered.</p>
Confidence Level (Only for LPR1 and LPR2)	<p>You can set the confidence level from 1 to 10.</p> <p>When the confidence level of the license plate is higher than the set confidence level, it will push the license plate image to the Smart Search interface.</p>
Repeat Plate Checktime	<p>Set the time interval for repeatedly reading license plates to effectively avoid duplicate identification of parking vehicles.</p> <p>You can set Repeat Plate Checktime from 0 to 60min or 0 to 60000ms.</p>
Feature Identification	<p>Check Region(Only for LPR2), Direction Region, Direction or All to enable Feature Identification, it will display the corresponding information on the Smart Search interface.</p>
Enable LPR Message Post	<p>Check the checkbox to enable LPR Message Post. It will push information to some third-party devices or software that are compatible with ours.</p>
Post Type	<p>Information can be pushed by RTSP, TCP or HTTP.</p>
HTTP Method	<p>There are two HTTP push methods, including Post and Get.</p>
Snapshot Type	<p>Three kinds of snapshot can be chosen: All, License Plate and Full Snapshot. When you choose All, License Plate Snapshot and Full Snapshot will be pushed.</p> <p>Note: This option is available just for Post HTTP Method.</p>

HTTP Notification URL	LPR camera can use the API URL to send LPR information to back-end devices when the license plate is recognized. API URL format fills as below: http://IP:Port/api/lpr?
User Name	Receiver name
Password	Receiver Password

Note:

License Plate Serial Format function supports formulating identification rules and can automatically do further processing, filter license plates in non-compliant formats to achieve more intelligent and accurate license plate recognition.

Advanced

In the interface, you can set display information on snapshot of license plate recognition, and also customize the file name of snapshots which are uploaded via FTP or Email or stored on local LPR Picture File Path.

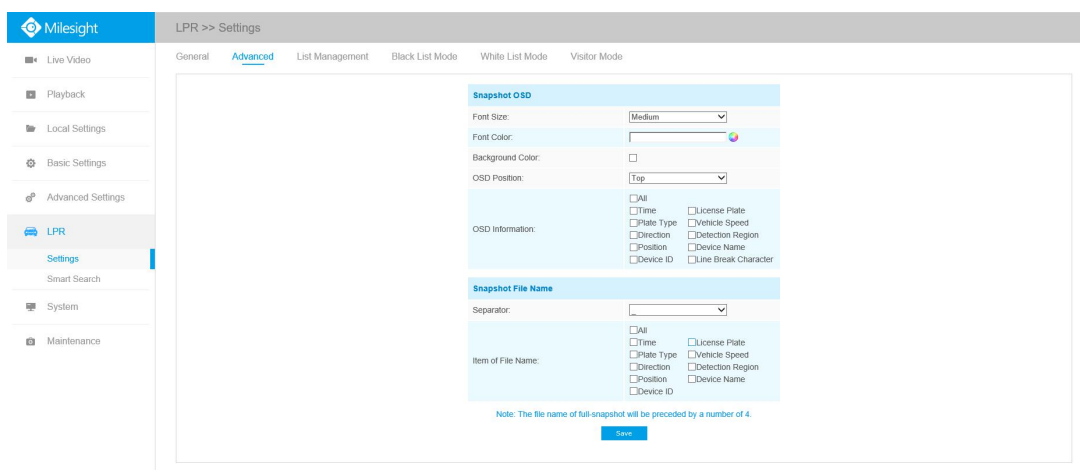
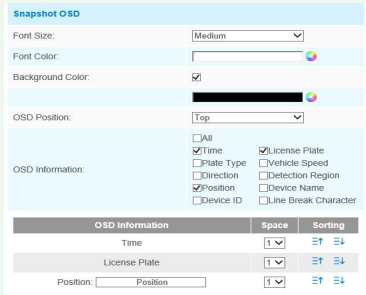



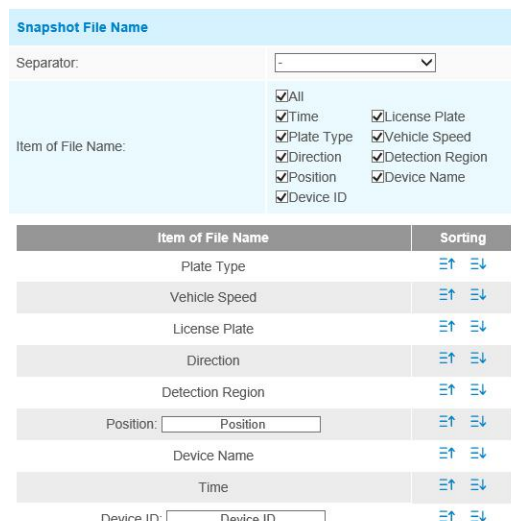

Table 4-6-3 Description of the buttons

Parameters	Function Introduction
Font Size	Small/Medium/Large are available for OSD information. Note: Snapshot OSD font size and Image OSD font size are corresponded.
Font Color	Enable to set different color for OSD information. Note: Snapshot OSD font color and Image OSD font color are corresponded.
Background Color	Check the checkbox to select background color of snapshot OSD information. Note: Background color cannot be the same with font color.
OSD Position	Check the checkbox to show OSD information position.

<p>OSD Information</p>	<p>Customize the OSD content. You can set OSD Information as shown below:</p>  <p>When license plate is recognized and the alarm is triggered, the snapshot of license plate recognition will show as below:</p> 
<p>Separator</p>	<p>“-”, “_” and Space are available for File Name Separator format. The default separator is “-”.</p>
<p>Item of File Name</p>	<p>You can customize the snapshot file name according to items chosen. The default items checked are Time and License Plate.</p>

Each time when an item is checked, the list will add the item row, including the item name and sorting operation. You can click  and  button to sort these items, and choose separator to connect these items name. Also, the content of Position and Device ID items can be customized. When you check all items, the function interface will show as below:





















Snapshot File Name

Separator:

Item of File Name:

- All
- Time
- License Plate
- Plate Type
- Vehicle Speed
- Direction
- Detection Region
- Position
- Device Name
- Device ID

Item of File Name	Sorting
Plate Type	 
Vehicle Speed	 
License Plate	 
Direction	 
Detection Region	 
Position: <input type="text" value="Position"/>	 
Device Name	 
Time	 
Device ID: <input type="text" value="Device ID"/>	 

Note: The file name of full-snapshot will be preceded by a number of 4.

Note:

You need to check at least one item.

For example, you can choose items, separator and items sorting as below:

Snapshot File Name

Separator:

Item of File Name:

- All
- Time
- License Plate
- Plate Type
- Vehicle Speed
- Direction
- Detection Region
- Position
- Device Name
- Device ID

Item of File Name	Sorting
Time	↑ ↓
License Plate	↑ ↓

Note: The file name of full-snapshot will be preceded by a number of 4.

Once license plate is recognized, and the snapshot will be uploaded via FTP or Email or stored on your local LPR Picture File Path. Then, You can see the snapshot file name which you customize as shown below:



420201116021729_RT528N

full-snapshot Recognized successfully



420201116021729_##528N

full-snapshot Recognized failed



20201116021729_RT528N

License plate snapshot Recognized successfully



20201116021729_##528N

License plate snapshot Recognized failed

Note:

- 1) If the item checked is not recognized successfully, then the item will be displayed with the specific symbol "#".
- 2) The file name of full-snapshot will be preceded by a number of 4.

List Management

Add the license plates to this interface as Black or White type (Black/White List), and then you can set the alarm action for these license plates in the corresponding black list mode or white list mode interface. When these license plates are detected, the camera will respond accordingly to your settings.

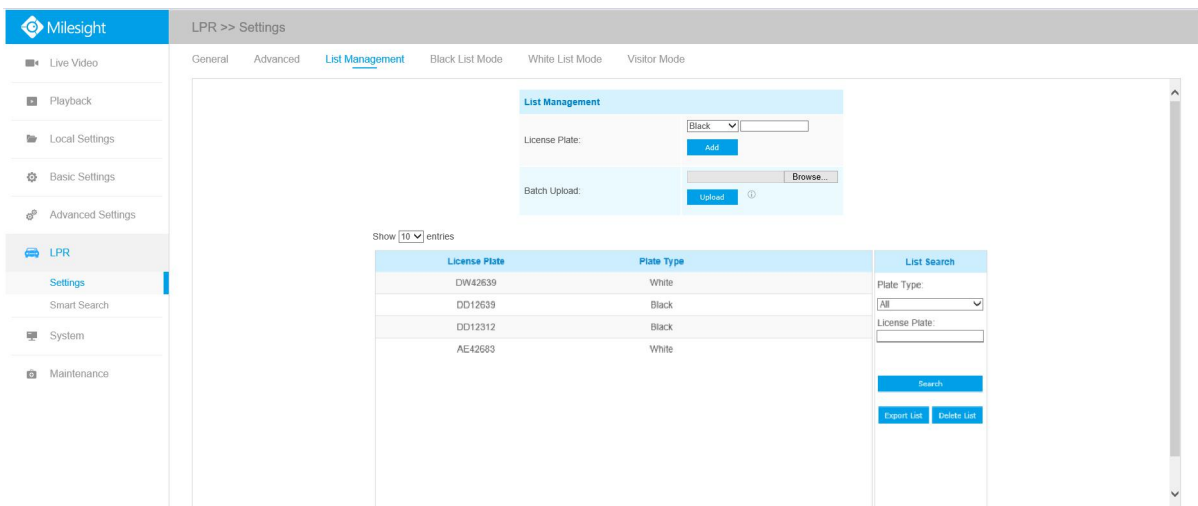
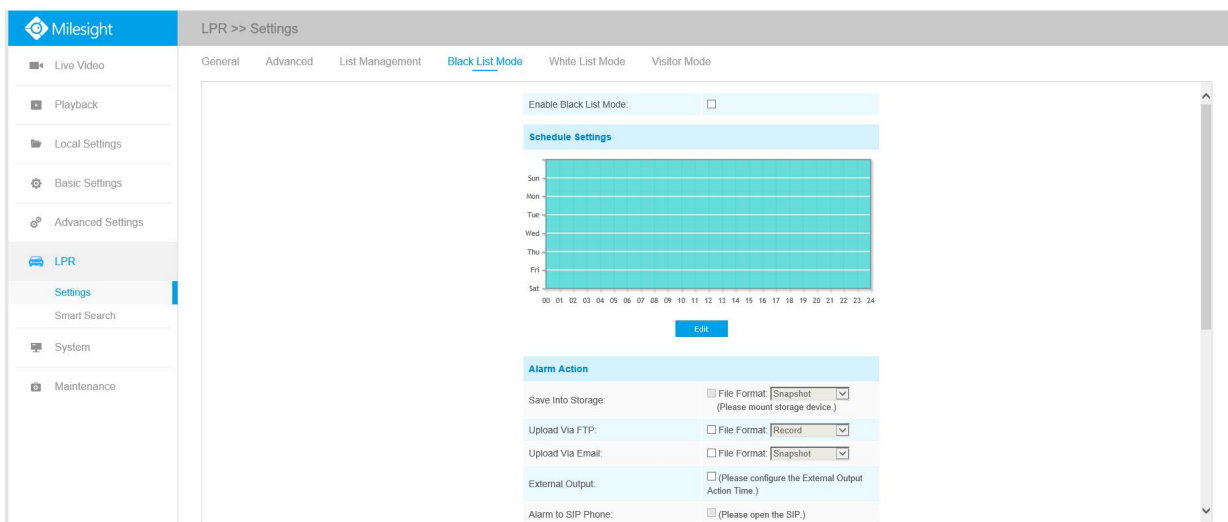

Table 4-6-3 Description of the buttons

Parameters	Function Introduction
Add License Plate	Select the license plate type as black or white, enter the license plate, click the "Add" button, the license plate will be added successfully.
Batch Upload	You can add a csv form with the license plate you want to add, click the "Browse" button to import the form to this interface, click the "Upload" button, the license plates will be added successfully. Note: You can first download the template as a reference in this interface.
List Search	Select Plate Type or directly enter the license plate number, click the "Search" button, the corresponding license plate will be displayed in the list below.
Export List	Click the "Export List" button to export the license plate in the current list to a csv form locally.
Delete List	Click the "Delete List" button to delete all the license plate in the current list.

Note: It supports adding 1000 Black List and White List.

Black List Mode



Step1: Check the checkbox to enable Black List Mode.

Step2: Schedule Settings. You can draw the schedule by clicking Edit button.

Step3: Set alarm action.

Alarm Action	
Save Into NAS:	<input type="checkbox"/> File Format: Record <input type="checkbox"/> Snapshot (Please mount storage device.)
Upload Via FTP:	<input type="checkbox"/> File Format: Record <input type="checkbox"/> Snapshot
Upload Via SMTP:	<input type="checkbox"/> File Format: Snapshot <input type="checkbox"/> Record
External Output:	<input type="checkbox"/> (Please configure the External Output Action Time.)
Play Audio:	<input type="checkbox"/> (Please configure the Audio Action Settings and Audio Interval.)
Alarm to SIP Phone:	<input type="checkbox"/> (Please open the SIP.)
HTTP Notification:	<input type="checkbox"/>

Step4: Set alarm settings.

Alarm Setting	
Record Video Sections:	5 seconds <input type="button" value="v"/>
Pre-record:	0 second <input type="button" value="v"/>
Snapshot Type:	License Plate <input type="button" value="v"/>
Snapshot:	3 <input type="button" value="v"/>
Snapshot Interval:	1 second <input type="button" value="v"/>
External Output Action Time:	30 seconds <input type="button" value="v"/>
Audio Action Settings:	<input type="button" value="Edit"/>
Play Audio Interval:	Auto <input type="button" value="v"/>

After that, when a license plate marked as “black” is detected, the camera will respond accordingly to your settings.

White List Mode

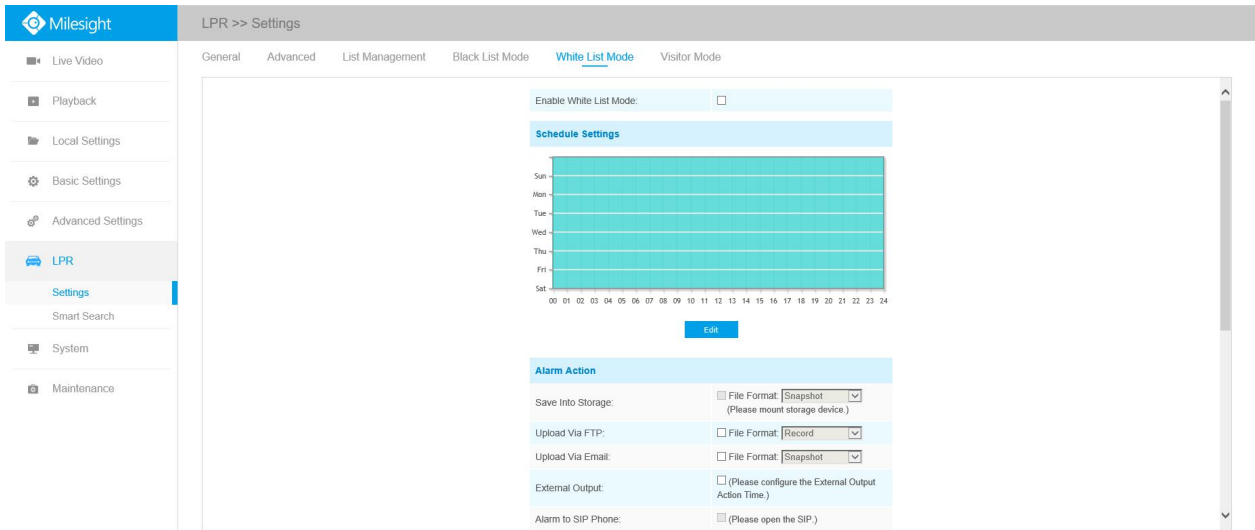

Step1: Check the checkbox to enable White List Mode.

Step2: Schedule Settings. You can draw the schedule by clicking Edit button.

Step3: Set alarm action.

Alarm Action	
Save Into NAS:	<input type="checkbox"/> File Format: Record (Please mount storage device.)
Upload Via FTP:	<input type="checkbox"/> File Format: Record
Upload Via SMTP:	<input type="checkbox"/> File Format: Snapshot
External Output:	<input type="checkbox"/> (Please configure the External Output Action Time.)
Play Audio:	<input type="checkbox"/> (Please configure the Audio Action Settings and Audio Interval.)
Alarm to SIP Phone:	<input type="checkbox"/> (Please open the SIP.)
HTTP Notification:	<input type="checkbox"/>

Step4: Set alarm settings.

Alarm Setting	
Record Video Sections:	5 seconds
Pre-record:	0 second
Snapshot Type:	License Plate
Snapshot:	3
Snapshot Interval:	1 second
External Output Action Time:	30 seconds
Audio Action Settings:	Edit
Play Audio Interval:	Auto

After that, when a license plate marked as “White” is detected, the camera will respond accordingly to your settings.

Visitor Mode

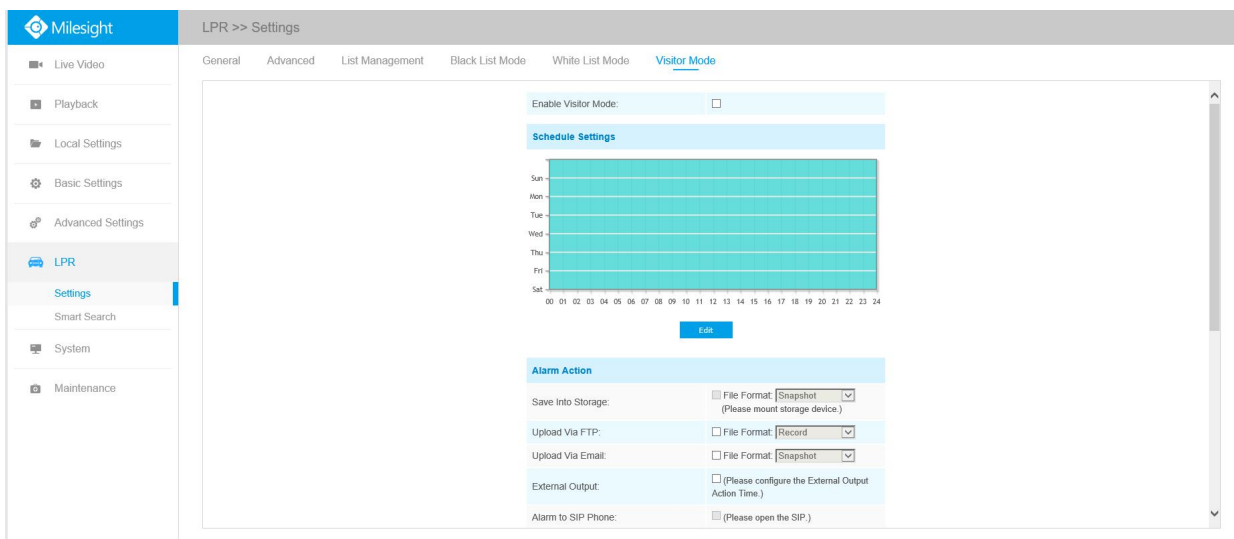

Step1: Check the checkbox to enable Visitor Mode.

Step2: Schedule Settings. You can draw the schedule by clicking Edit button.

Step3: Set alarm action.

Alarm Action	
Save Into NAS:	<input type="checkbox"/> File Format: Record (Please mount storage device.)
Upload Via FTP:	<input type="checkbox"/> File Format: Record
Upload Via SMTP:	<input type="checkbox"/> File Format: Snapshot
External Output:	<input type="checkbox"/> (Please configure the External Output Action Time.)
Play Audio:	<input type="checkbox"/> (Please configure the Audio Action Settings and Audio Interval.)
Alarm to SIP Phone:	<input type="checkbox"/> (Please open the SIP.)
HTTP Notification:	<input type="checkbox"/>

Step4: Set alarm settings.

Alarm Setting	
Record Video Sections:	5 seconds
Pre-record:	0 second
Snapshot Type:	License Plate
Snapshot:	3
Snapshot Interval:	1 second
External Output Action Time:	30 seconds
Audio Action Settings:	Edit
Play Audio Interval:	Auto

After that, when a license plate that is not marked as "Black" or "White" is detected, the camera will respond accordingly to your settings.

4.6.3 Smart Search

The real-time detection results will be displayed on the right side of Smart Search page, including detected time, live screenshot, and license plate.

Step1: Select Plate Type or directly enter the license plate number and then select Start Time and End Time. The related license plate information will be displayed as below by one click on the "Search" button.

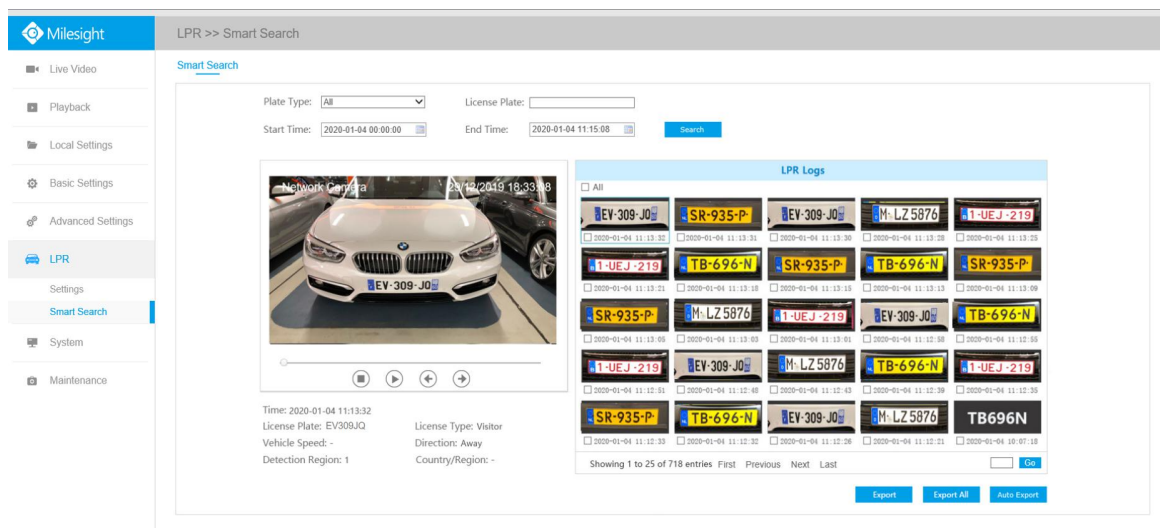

Note:

- (1) It supports displaying 4,000 logs.
- (2) Only when there is a SD Card or NAS has been set on the storage management , then the logs can be stored and show on Smart Search page.

Step2: Click on the thumbnail photo under the LPR Logs, then the license plate details will be shown as below :

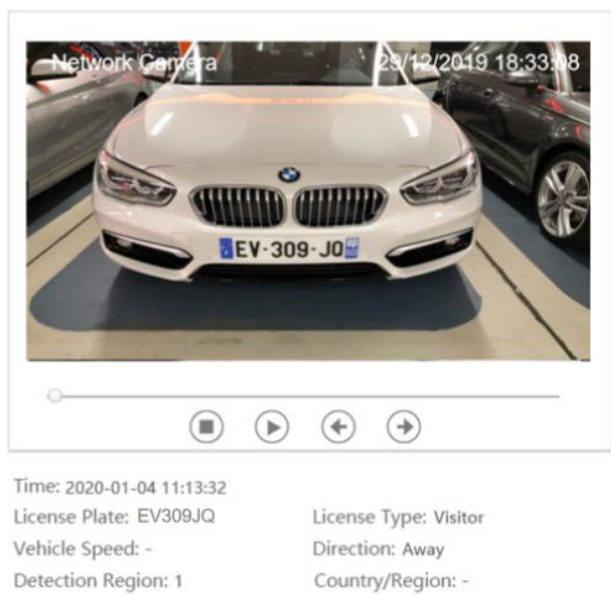

Step3: Click the "Export" or "Export All" button to export the desired files in the current list to a local folder.

Export

Export File: Plate List Video Picture

Video File Format:

Step4: Click the "Auto Export" button to automatically export the logs to FTP, Email or Storage.

Milesight Network Camera ✕

Log Settings

Enable Auto Export Logs:

Day:

Time:

Export Time Range:

Export to: FTP Email Storage

4.7 System

All information about the hardware and software of the camera can be checked on this page.

System	
Device Name:	<input type="text" value="Pro Bullet"/>
Product Model:	MS-C2962-FPB
Hardware Version:	V1.0
Software Version:	40.7.0.74
MAC Address:	1C:C3:16:21:09:91
Device Information:	SA100EE3F0N
Alarm Input:	1
Alarm Output:	1
Uptime:	3 days 21 hours 26 minutes
QR Code:	 <p style="font-size: small; text-align: center;">Please scan this QR code on App to get a remote view.</p>

Table 4-7-1 Description of the buttons

Parameters	Function Introduction
Device Name	The device name can be customized. It will be seen in file names of video files
Product Model	The product model of the camera
Hardware Version	The hardware version of the camera
Software Version	The software version of the camera can be upgraded
MAC Address	Media Access Control address
Device Information	The device information, including information about alarm I/O and clipper chip
Alarm Input	The number of Alarm Input interface
Alarm Output	The number of Alarm Output interface
Uptime	The elapsed time since the last restarted of the device

Note:

The Alarm Input/Alarm Output will appear only when the camera have alarm input/output interface.

4.8 Maintenance

4.8.1 System Maintenance

System Upgrade

Software Version: 43.7.0.76

Local Upgrade: Reset after Upgrading

Online Upgrade:

Note: Do not disconnect the power of the device during the upgrade.

Maintenance

Reset Keep the IP Configuration Keep the User Information

Export Diagnose Information:

Export Config File:

Config File:

Import Config File:

Reboot

Reboot the Device:

Table 4-8-1 Description of the buttons

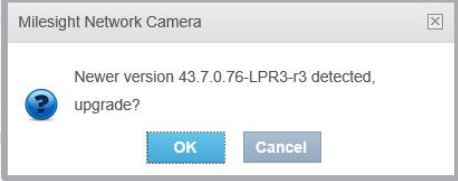
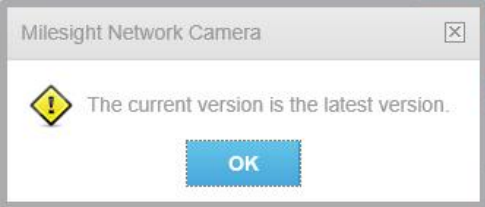
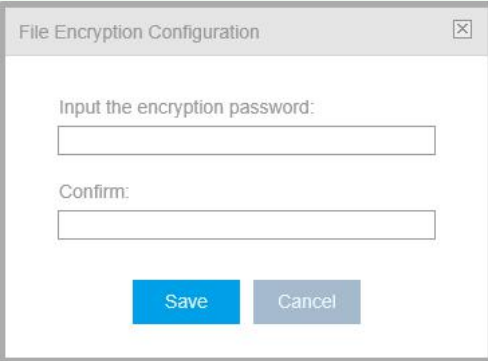
Parameters	Function Introduction
<p>System Upgrade</p>	<p>Software Version: The software version of the camera.</p> <p>Local Upgrade: Click the “Browse” button and select the upgrading file, then click the “Upgrade” button to upgrade. After the system reboots successfully, the update is done.</p> <p>You can check “Reset after Upgrading” to reset the camera after upgrading it.</p> <p>Online Upgrade: Click the "Check" button to check the current latest firmware version on our website, and then click "OK" to upgrade to this version.</p>  <p>It will prompt "The current version is the latest version" if your camera is already the latest version.</p>  <p>Note: Do not disconnect the power of the device during the update. The device will be restarted to complete the upgrading.</p>
<p>Maintenance</p>	<p>Reset settings: Click “Reset” button to reset the camera to factory default settings</p> <p>Keep the IP Configuration: Check this option to keep the IP configuration when resetting the camera.</p> <p>Keep the User information: Check this option to keep the user information when resetting the camera.</p> <p>Export Diagnose Information: Click this button to export logs and system information of the device operation status.</p> <p>Note: The file format is “.txt”.</p> <p>Export Config File: Click this button and a window will pop up as shown below:</p>  <p>You need to enter and confirm password again, then click save button to export configuration file.</p>

Import Config File: Click this button, then a window will pop up and you can click "OK" to update the configuration.

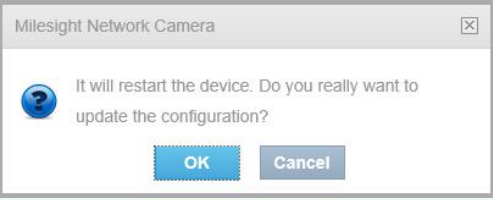

The screenshot shows a dialog box titled "Milesight Network Camera" with a close button in the top right corner. Inside the dialog, there is a question mark icon followed by the text: "It will restart the device. Do you really want to update the configuration?". At the bottom of the dialog, there are two buttons: "OK" and "Cancel".

It will pop up a window to prompt "Input the password of config file" , then enter password and click save button to import configuration file.

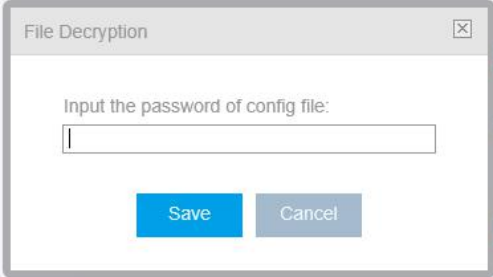

The screenshot shows a dialog box titled "File Decryption" with a close button in the top right corner. Inside the dialog, there is a text input field with the label "Input the password of config file:". Below the input field, there are two buttons: "Save" and "Cancel".

Note: Export and import the same configuration file. Password must be the same.

Reboot Click "Reboot" button to restart the device immediately

4.8.2 Auto Reboot

Set the date and time to enable Auto Reboot function, the camera will reboot automatically according to the customized time in case that camera overload after running a long time.

Auto Reboot Settings	
Enable Auto Reboot:	<input type="checkbox"/>
Day:	Everyday ▼
Time:	00:00:00 📅

[Save](#)

Chapter V Services

Milesight Technology Co., Ltd provides customers with timely and comprehensive technical support services. End-users can contact your local dealer to obtain technical support. Distributors and resellers can contact directly with Milesight for technical support.

Technical Support Mailbox: support@milesight.com

Web: <http://www.milesight.com>

Online Problem Submission System: <http://www.milesight.com/service/feedback.asp>

MILESIGHT USA

TEL: +1-800-561-0485

Add: 7509 N.W. 36th Street, Miami, Florida 33166, USA

MILESIGHT KOREA

TEL: +82-2-839-3335

Add: 925, Anyang SK V1 Center, LS-ro 116beon-gil, Dongan-gu, Anyang-si, Korea

MILESIGHT CHINA

TEL: +86-592-5922772

Add: No.23 Wanghai Road,2nd Software Park, Xiamen, China

Milesight
Better Inside, More in Sight