

# **Professional Surveillance Keyboard**

## User Manual

Manual Version: V1.02

Thank you for purchasing our product. If there are any questions, or requests, please do not hesitate to contact the dealer.

## Trademark Acknowledgement

The trademarks, company names and product names contained in this manual are the property of their respective owners.

## Disclaimer



### CAUTION!

The default password is used for your first login. To ensure account security, please change the password after your first login. You are recommended to set a strong password (no less than eight characters).

---

- To the maximum extent permitted by applicable law, the product described, with its hardware, software, firmware and documents, is provided on an "as is" basis.
- Best effort has been made to verify the integrity and correctness of the contents in this manual, but no statement, information, or recommendation in this manual shall constitute formal guarantee of any kind, expressed or implied. We shall not be held responsible for any technical or typographical errors in this manual. The contents of this manual are subject to change without prior notice. Update will be added to the new version of this manual.
- Use of this manual and the product and the subsequent result shall be entirely on the user's own responsibility. In no event shall we be liable for any special, consequential, incidental, or indirect damages, including, among others, damages for loss of business profits, business interruption, or loss of data or documentation, or product malfunction or information leakage caused by cyber attack, hacking or virus in connection with the use of this product.

- Video and audio surveillance can be regulated by laws that vary from country to country. Check the law in your local region before using this product for surveillance purposes. We shall not be held responsible for any consequences resulting from illegal operations of the device.
- The illustrations in this manual are for reference only and may vary depending on the version or model. The screenshots in this manual may have been customized to meet specific requirements and user preferences. As a result, some of the examples and functions featured may differ from those displayed on your monitor.
- This manual is a guide for multiple product models and so it is not intended for any specific product.
- Due to uncertainties such as physical environment, discrepancy may exist between the actual values and reference values provided in this manual. The ultimate right to interpretation resides in our company.



## Environmental Protection

This product has been designed to comply with the requirements on environmental protection. For the proper storage, use and disposal of this product, national laws and regulations must be observed.

## Safety and Compliance Information



### Safety Symbols

The symbols in the following table may be found on installation-related equipment. Be aware of the situations indicated and take necessary safety precautions during equipment installation and maintenance.

Symbol	Description
	Generic alarm symbol: To suggest a general safety concern.
	ESD protection symbol: To suggest

Symbol	Description
	electrostatic-sensitive equipment.
	Electric shock symbol: To suggest a danger of high voltage.

The symbols in the following table may be found in this manual. Carefully follow the instructions indicated by the symbols to avoid hazardous situations and use the product properly.

Symbol	Description
 <b>WARNING!</b>	Indicates a hazardous situation which, if not avoided, could result in bodily injury or death.
 <b>CAUTION!</b>	Indicates a situation which, if not avoided, could result in damage, data loss or malfunction to product.
 <b>NOTE!</b>	Indicates useful or supplemental information about the use of product.

## Safety Information

Installation and removal of the unit and its accessories must be carried out by qualified personnel. Please read all of the safety instructions below before installation and operation.

- This device is a class A product and may cause radio interference. Take measures if necessary.
- While shipping, the device should be packed in its original packing.
- Verify that installation is correct. Incorrect cable connection may cause personal injury or device damage.
- The installation must be made by qualified personnel and should conform to all the local codes.
- If the product does not work properly, please contact your dealer. Never attempt to disassemble the device yourself. We shall not

assume any responsibility for problems caused by unauthorized repair or maintenance.

- Ensure a proper operating environment, including temperature, humidity, ventilation and power supply. Make sure the device is properly grounded and the lightning protection meets requirements. Keep the device from moisture, dust, strong electromagnetic radiation and vibration.
  - Power down the device before connecting and disconnecting accessories and peripherals.
  - Protect the power cable from being stepped on or pressed, particularly at the plug, receptacle, and the part leading out of the device.
  - Strictly follow the procedure to shut down the device. Sudden power failures can cause disk damage and functional abnormalities. In an environment where power supply is frequently interrupted, use an Uninterrupted Power Supply (UPS).
  - Take necessary measures to ensure data security and protect the device from network attack and hacking (when connected to Internet). Possible risks and consequences are at user's sole discretion.
- 



#### **WARNING!**



- Never look at the transmit laser while the power is on. Never look directly at the fiber ports and the fiber cable ends when they are powered on.
  - Use of controls or adjustments to the performance or procedures other than those specified herein may result in hazardous laser emissions.
-

## Regulatory Compliance

### FCC statements

This device complies with Part 15 of the FCC Rules. Operation is subject to the following two conditions: (1) this device may not cause harmful interference, and (2) this device must accept any interference received, including interference that may cause undesired operation.

**Caution:** The user is cautioned that changes or modifications not expressly approved by the party responsible for compliance could void the user's authority to operate the equipment.

**NOTE:** This equipment has been tested and found to comply with the limits for a Class A digital device, pursuant to part 15 of the FCC Rules. These limits are designed to provide reasonable protection against harmful interference when the equipment is operated in a commercial environment. This equipment generates, uses, and can radiate radio frequency energy and, if not installed and used in accordance with the instruction manual, may cause harmful interference to radio communications. Operation of this equipment in a residential area is likely to cause harmful interference in which case the user will be required to correct the interference at his own expense.

### LVD/EMC Directive



This product complies with the European Low Voltage Directive 2014/35/EU and EMC Directive 2014/30/EU.

## **WEEE Directive–2012/19/EU**



The product this manual refers to is covered by the Waste Electrical & Electronic Equipment (WEEE) Directive and must be disposed of in a responsible manner.

## **Battery Directive-2013/56/EC**



Battery in the product complies with the European Battery Directive 2013/56/EC. For proper recycling, return the battery to your supplier or to a designated collection point.

# Contents

<b>1 Appearance.....</b>	<b>1</b>
Packing List .....	1
Keyboard Layout .....	1
Joystick Function .....	4
Keyboard Interfaces .....	5
<b>2 Cable Connection.....</b>	<b>6</b>
Connect RS485 Connector.....	6
<b>3 Startup and Shutdown.....</b>	<b>6</b>
Startup.....	6
Shutdown .....	7
<b>4 Setup.....</b>	<b>8</b>
Set the Network.....	8
Add NVR Devices .....	8
Manage Users.....	10
<b>5 Common Operations.....</b>	<b>10</b>
Basic Concept .....	10
Control a PTZ Camera .....	10
Play Live Video .....	12
Playback.....	13
Control Menus .....	13
Multi-Window View .....	14
Set Preset.....	14
Invoke Preset.....	14
Invoke Preset Patrol .....	15
Invoke Recorded Patrol.....	16
Sequence .....	17



# 1 Appearance

The images are for reference only and may be different from the device.

## Packing List

Please check the items in your package carefully. Contact your dealer if anything is missing or damaged.







- Keyboard
- Feet (4 pcs)
- Serial port cable (1 pcs)
- User document

## Keyboard Layout



**Table 1-1** Keyboard Layout

No.	Name	Description	
1	Screen	LCD screen.	
2	Indicator	PWR (Power)	Steady blue: normal operation.
		NET (Network)	Steady blue: normal network connection.
		TX/RX (Data)	Blinks blue: transmitting data.

No.	Name	Description	
	transmission)		
	ALM (Alarm)	Blinks red: alarm occurred.	
3	Playback keys		Reserved.
			Reserved.
			Reserved.
			Reserved.
			Reserved.
			Reserved.
4	Knob		Reserved.
5	Function keys	ESC	Cancel or exit.
		LOCK	Lock.
		SYS	Open the main menu.
		SHIFT	Switch input method.
		ID	Device ID.
		SET	Set.
		MON	Use with a number key to select a monitor.
		WIN	Use with a number key to select a window on screen.
		CAM	Use with a number key to select a camera.
		PANEL	Reserved.
		MULT	Use with a number key to set a multi-window view on screen.
		MON_G	Reserved.
		CAM_G	Reserved.
		GROUP	Reserved.
		PRESET	Call or set preset.
PATROL	Call or set patrol.		
ROUTE	Call or set route.		

No.	Name	Description	
	RUN/STOP	Reserved.	
	REC	Reserved.	
	PREV	Display the previous screen in NVR control mode during sequence.	
	NEXT	Display the next screen in NVR control mode during sequence.	
6	Number/letter keys	Number keys (1 to 9) and letter keys (A to Z)	Input numbers or letters. Press SHIFT to switch.
		CLEAR	Delete input.
		0/ 	<ul style="list-style-type: none"> <li>● Number key 0.</li> <li>● Space.</li> </ul>
		ENTER	Confirm.
7	PTZ control keys	FOCUS+/MENU	<ul style="list-style-type: none"> <li>● Increase camera focus in PTZ control mode.</li> <li>● Open the main menu in NVR control mode.</li> </ul>
		FOCUS-/R_CLICK	<ul style="list-style-type: none"> <li>● Decrease camera focus in PTZ control mode.</li> <li>● In NVR control mode, show the shortcut menu that appears with a right-click of the mouse.</li> </ul>
		IRIS+/MUTE	<ul style="list-style-type: none"> <li>● Increase camera iris in PTZ control mode.</li> <li>● Turn off audio in NVR control mode.</li> </ul>
		IRIS-/TOOLBAR	<ul style="list-style-type: none"> <li>● Decrease camera iris in PTZ control mode.</li> <li>● Display toolbar in NVR control mode.</li> </ul>
		ZOOM+/F1	<ul style="list-style-type: none"> <li>● Zoom in in PTZ control mode.</li> <li>● Switch active area (e.g., text box, drop-down list) on a tab in NVR control mode (same as F1).</li> </ul>

No.	Name		Description
		ZOOM-/F2	<ul style="list-style-type: none"> <li>Zoom out in PTZ control mode.</li> <li>Switch tabs in NVR control mode (same as F2).</li> </ul>
		LIGHT/PTZ	<ul style="list-style-type: none"> <li>Turn on light in PTZ control mode.</li> <li>Display PTZ control window in NVR control mode.</li> </ul>
		WIPER/EDIT	<ul style="list-style-type: none"> <li>Turn on wiper in PTZ control mode.</li> <li>Switch control mode in NVR control mode.</li> <li>Input numbers or letters in menu mode.</li> </ul>
8	Auxiliary keys (AUX1-AUX5)		For expansion.
9	Joystick		Control PTZ cameras. See Joystick Function for details.
10	SWITCH		<ul style="list-style-type: none"> <li>Press once: confirm.</li> <li>Press twice: snapshot when controlling PTZ camera or recording video.</li> </ul>

## Joystick Function

**Table 1-2** Joystick Functions

Operation	Description
Up	<ul style="list-style-type: none"> <li>Navigate between menu items.</li> <li>Tilt up in PTZ control mode.</li> <li>Play fast or select the previous menu in NVR control mode.</li> </ul>
Down	<ul style="list-style-type: none"> <li>Navigate between menu items.</li> <li>Tilt down in PTZ control mode.</li> <li>Play slow or select the next menu in NVR control mode.</li> </ul>
Left	<ul style="list-style-type: none"> <li>Navigate between menu items.</li> <li>Turn left in PTZ control mode.</li> </ul>

Operation	Description
Right	<ul style="list-style-type: none"> <li>• Navigate between menu items.</li> <li>• Turn right in PTZ control mode.</li> </ul>
Upper left/lower left/upper right/lower right	Control directions in PTZ control mode.
Rotate counterclockwise	Zoom out in PTZ control mode.
Rotate clockwise	Zoom in in PTZ control mode.



**NOTE!**

In PTZ control mode, the further you tilt the joystick, the faster the camera rotates. The joystick allows the maximum rotation degree of  $\pm 45^\circ$ . Use the joystick carefully to avoid damage.

## Keyboard Interfaces

### Network keyboard

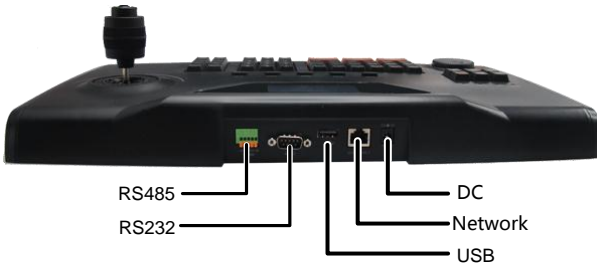

### Serial-interface keyboard

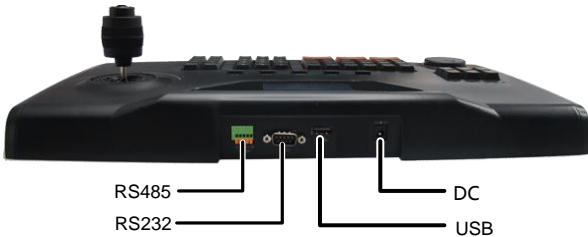

## 2 Cable Connection

---

### Connect RS485 Connector

Connect an NVR through the RS485 connector.

Connect A of the RS485 connector to RS485+ of NVR, and connect B to RS485- of NVR, as shown below.

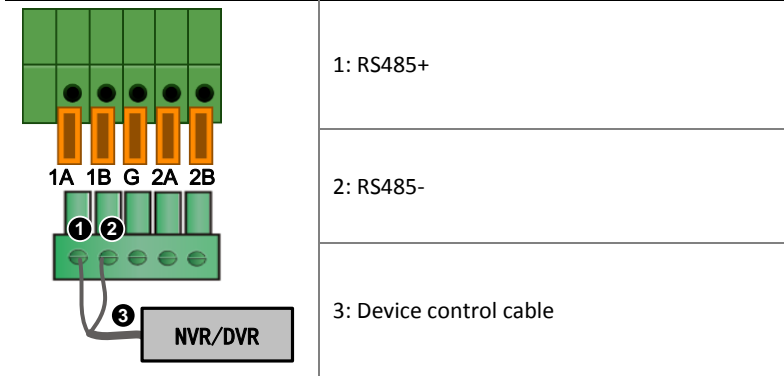

#### NOTE!

Only 2A and 2B of the RS485 connector can be used to connect keyboards in parallel.

---

## 3 Startup and Shutdown

---

### Startup

1. Connect power. The power LED is lit. When the system time displays on the screen, press ENTER.

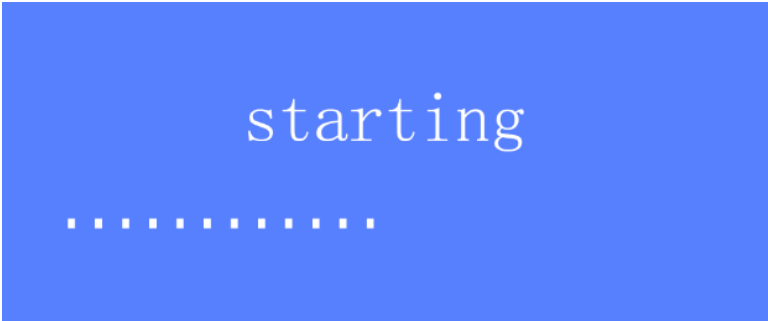

2. Use the joystick (tilt left/right/up/down) to navigate and input the correct username and password.



**NOTE!**

- The default admin username/password is admin/123456. The default operator username/password is user/123456.
- Press SHIFT to switch inputs between numeric, uppercase letters, and lowercase letters.
- When locked, the system time displays on the screen. To display the main menu, press ENTER and input the username and password.

3. Press ENTER to display the main menu.

## Shutdown

Exit the system and then unplug power to shut down the keyboard.

## 4 Setup

---

Access the main menu first. See Startup for detailed steps.

### Set the Network

1. Tilt the joystick up/down to navigate. Press ENTER to select. Press ESC to exit.

Path: Main Menu>Local Cfg>Net Cfg



2. Use the joystick to locate the cursor. Press number keys to input the IP, subnet mask, and gateway.

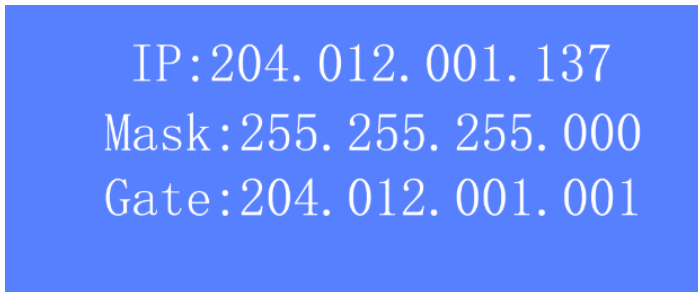

#### NOTE!

Default IP address: 192.168.1.16.

---

### Add NVR Devices

Only admin can add devices.

#### Preparation

- Log in to the NVR and note down its device ID (to be used in Step 2).
- Make sure the NVR to add is connected.



## Steps

1. Tilt the joystick up/down to navigate. Press ENTER to select.

Path: Main Menu>Dev Manage>Manual Cfg>Add Dev



2. Set the device ID, name, type and connection method, and press ENTER.



3. Input NVR's IP.

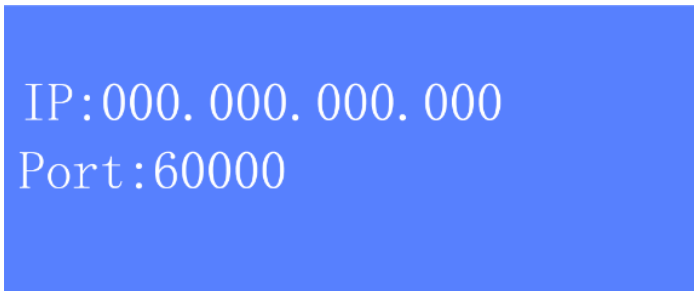

### NOTE!

The device ID must be set correctly. See Basic Concept for details.

---

- If the keyboard is connected to the NVR through an RS232 or RS485 interface, press ENTER and then complete settings. The protocol, baud rate, data bit, check bit, and stop bit should be the same as settings in the NVR.

- If the keyboard is connected to the NVR through network, press ENTER and then input the NVR's IP address.

## Manage Users

1. Tilt the joystick up/down to navigate. Press ENTER to select.  
Path: Main Menu>Advance Cfg>User Manage
2. Add and delete users as needed or change user password.

# 5 Common Operations

---

Access the main menu first. See Startup for detailed steps.

## Basic Concept

ID refers to device ID.

If the NVR is connected through the RS485 serial interface, you need to input the NVR's actual ID (you can find out by logging in to the NVR) and set the serial interface in the NVR as follows: serial interface mode to keyboard, protocol to UV-1, baud rate to 9600, data bit to 8, stop bit to 1, and check bit to none.

If the NVR is connected through network, the preceding requirement on ID is unnecessary because device IDs are only used for searching.

## Control a PTZ Camera

Use the joystick or PTZ control keys to operate a PTZ camera connected via an NVR.



### Option 1

1. Press ID.



ID:133

2. Input the NVR's device ID and then press ENTER. The basic device information is displayed.



ID:133  
Name:133  
D\_Type:NVR  
L\_Type:NetWork

3. Press ENTER to confirm.
4. Press a number key and then press MON to specify the monitor.



I D:133  
MON:                   WIN:  
CAM:  
PNL:Right

5. Press a number key and then press WIN to specify the preview window linked to the PTZ camera.



---

**NOTE!**

- You need to log into the NVR first; otherwise PTZ control is unavailable.
  - PTZ control is unavailable if the specified window links to more than one camera.
- 

6. Press PTZ to activate PTZ control mode.
  - Use the PTZ control keys to adjust zoom and focus.
  - Use the joystick to control the rotation direction and speed (speed depends on the degree of rotation). Twist the joystick to zoom in and out.
7. Press ESC to exit PTZ control mode.

**Option 2**

You need to log in to the NVR and note down the camera's device ID (to be used in Step 4).

1. Press ID.
2. Input the NVR's device ID and then press ENTER. The basic device information is displayed.
3. Press ENTER to confirm.
4. Press a number key and then press CAM to specify the PTZ camera.
5. Press PTZ to activate PTZ control mode.
  - Use the PTZ control keys to adjust zoom and focus.
  - Use the joystick to control the rotation direction and speed (speed depends on the degree of rotation). Twist the joystick to zoom in and out.
6. Press ESC to exit PTZ control mode.

**Play Live Video**

Play live video on the monitor's screen in the current screen layout (e.g., 4 windows).

1. Press ID.

2. Input the NVR's device ID and then press ENTER. The basic device information of is displayed.
3. Press ENTER to confirm.
4. Press a number key and then press MON to specify the monitor.
5. Press a number key and then press WIN to specify the preview window.
6. Press a number key and then press CAM to specify the camera.
7. Press ENTER.

## Playback

1. Press ID.
2. Input the NVR's device ID and then press ENTER. The basic device information of is displayed.
3. Press ENTER to confirm.
4. Press R\_CLICK to show the shortcut menu and push down the joystick to choose playback, then click the joystick to display playback screen
5. Use the joystick to select the camera and the playback time, then click the joystick to start playback.

## Control Menus

1. Press ID.
2. Input the device ID and then press ENTER.
  - R\_CLICK: Show the shortcut menu that appears with a right-click of the mouse in a preview window.
  - MENU: Display the main menu.
  - ESC: Return to the previous window.
  - MUTE: Turn off audio
  - TOOLBAR: Show the toolbar
  - F1: Switch active area such as text box, drop-down list on a tab.

- F2: Switch tab on screen

## Multi-Window View

Change the preview layout (number of on-screen windows) on NVR.

1. Press ID.
2. Input the NVR's device ID and then press ENTER.
3. Press MULT till the desired multi-window view appears, or press a number key and then press MULT.

## Set Preset

The ID of preset ranges from 0 to 255.

1. Press ID.
2. Input the NVR's device ID and then press ENTER. The basic device information is displayed.
3. Press ENTER to confirm.
4. Press a number key and then press CAM to specify the PTZ camera.
5. Press PTZ to activate PTZ control mode.
6. Press SET to change PTZ mode



7. press the ID of preset, then use the joystick to place PTZ, and press PRESET in the end
8. repeat the 7th step to set the next preset.

## Invoke Preset

The premise of Invoke preset is you have set preset.

1. Press ID.
2. Input the NVR's device ID and then press ENTER. The basic device information is displayed.
3. Press ENTER to confirm.
4. Press a number key and then press CAM to specify the PTZ camera.
5. Press PTZ to activate PTZ control mode.
6. Press the ID of preset that you want and press preset to invoke the preset.



## Invoke Preset Patrol

The premise of starting preset patrol is you have set preset patrol.

1. Press ID.
2. Input the NVR's device ID and then press ENTER. The basic device information is displayed.
3. Press ENTER to confirm.
4. Press a number key and then press CAM to specify the PTZ camera.
5. Press PTZ to activate PTZ control mode.
6. Press the ID of preset patrol that you want and press patrol to invoke the preset patrol.



```
ID:133
MON:      WIN:
CAM:
PTZ:Patrol
```

7. Press the number + patrol to stop the preset patrol.

## Invoke Recorded Patrol

The premise of starting recorded patrol is you have set recorded patrol.

1. Press ID.
2. Input the NVR's device ID and then press ENTER. The basic device information is displayed.
3. Press ENTER to confirm.
4. Press a number key and then press CAM to specify the PTZ camera.
5. Press PTZ to activate PTZ control mode.
6. Press number 1 and press route to invoke the recorded patrol



```
ID:133
MON:      WIN:
CAM:
PTZ:Route
```

7. Press the number 1 + route to stop the recorded patrol.



**NOTE!**

- NVR support patrol only if the version is after D021SP05.
- 

## Sequence

The number of window is less than the number of IPC(for example,you want 4 multi-window and have 9 IPC.)

1. Press ID.
2. Input the NVR's device ID and then press ENTER. The basic device information is displayed.
3. Press ENTER to confirm.
4. Press 4 and MULT to display 4 window on the screen.
5. Press RUN to start Sequence
6. Press RUN to stop Sequence.